



US00D516685S

(12) **United States Design Patent**
Kennard

(10) **Patent No.:** **US D516,685 S**
(45) **Date of Patent:** **** Mar. 7, 2006**

(54) **FAUCET SPOUT**

D491,633 S * 6/2004 Ouyoung D23/238
D491,637 S * 6/2004 Lin D23/255

(75) **Inventor:** **Dan Kennard**, Norcross, GA (US)

* cited by examiner

(73) **Assignee:** **Fusion Hardware Group, INC**,
Norcross, GA (US)

Primary Examiner—Louis S. Zarfaz

Assistant Examiner—Gregory Andoll

(**) **Term:** **14 Years**

(74) *Attorney, Agent, or Firm*—Troxell Law Office, PLLC

(21) **Appl. No.:** **29/206,822**

(57) **CLAIM**

(22) **Filed:** **Jun. 4, 2004**

The ornamental design for faucet spout, as show and described.

(51) **LOC (8) Cl.** **23-01**

DESCRIPTION

(52) **U.S. Cl.** **D23/255; D23/257**

FIG. 1 is a perspective view of faucet spout showing my new design;

(58) **Field of Classification Search** D23/238–257;
4/675–678; 137/801

FIG. 2 is a front elevational view thereof;

See application file for complete search history.

FIG. 3 is a rear elevational view thereof;

FIG. 4 is a left elevational view thereof;

FIG. 5 is a right elevational view thereof;

FIG. 6 is a top plan view thereof; and,

FIG. 7 is a bottom plan view thereof.

(56) **References Cited**

U.S. PATENT DOCUMENTS

D490,880 S * 6/2004 Lin D23/255

D490,881 S * 6/2004 Lin D23/257

1 Claim, 4 Drawing Sheets

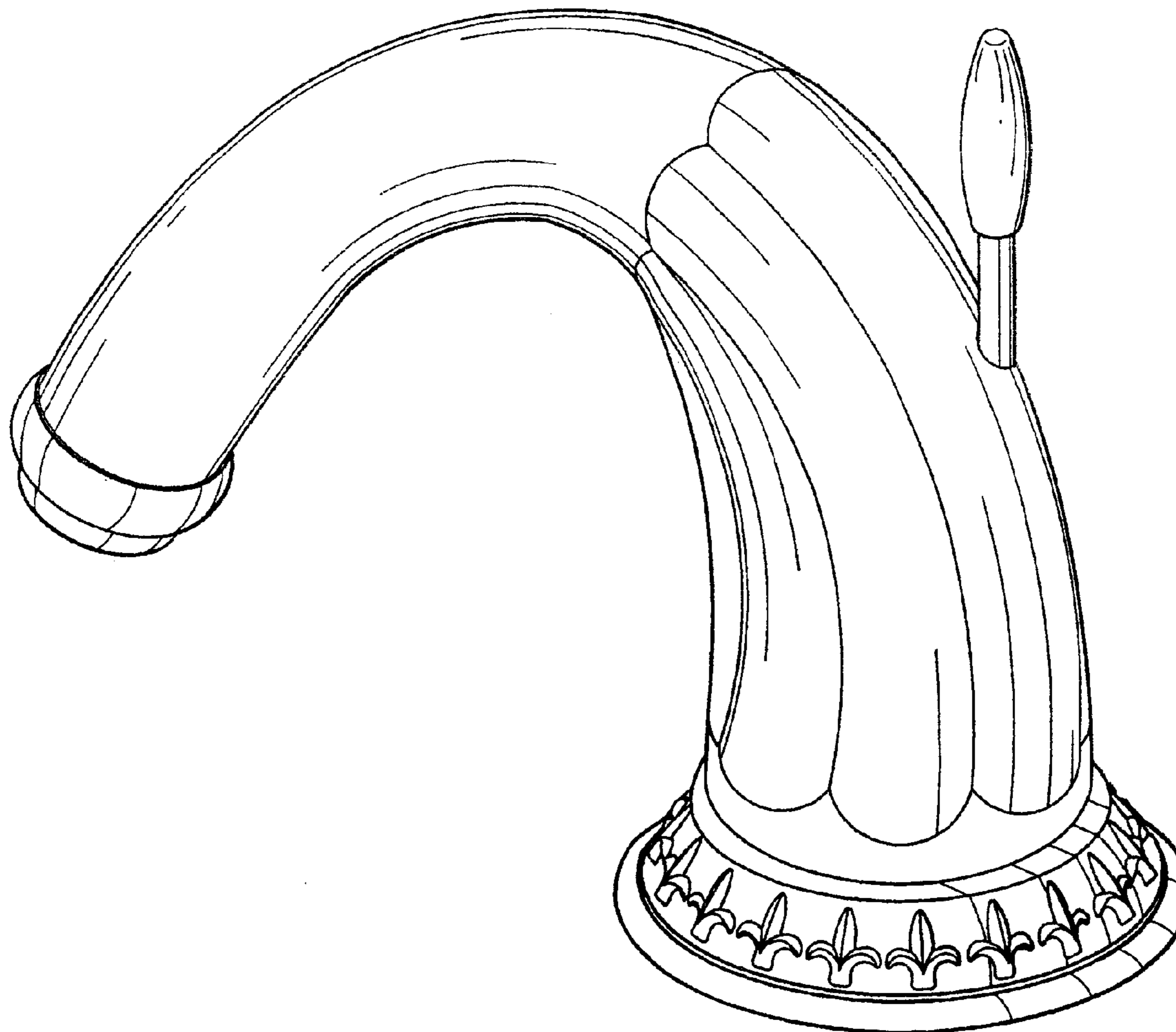

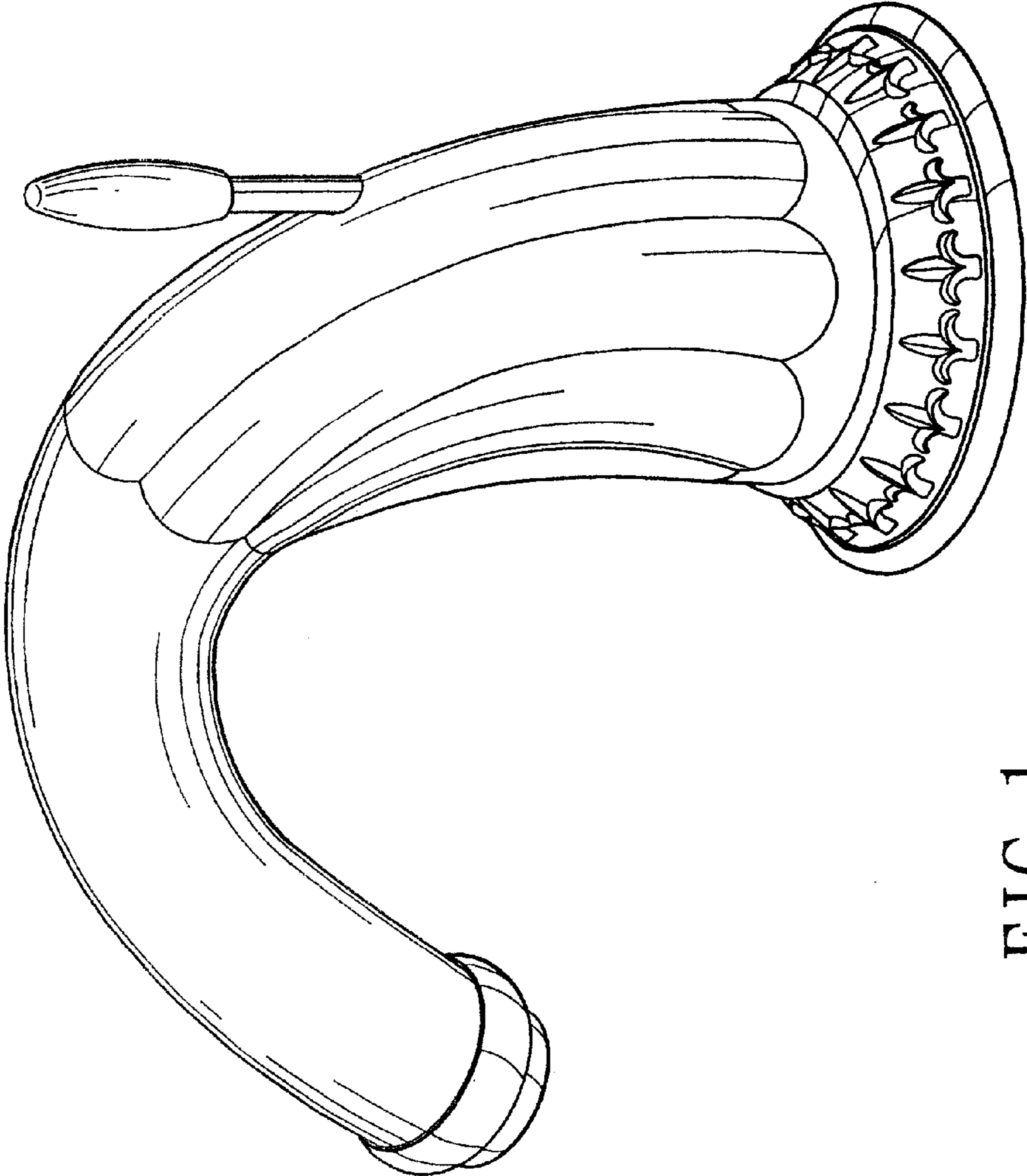

FIG. 1

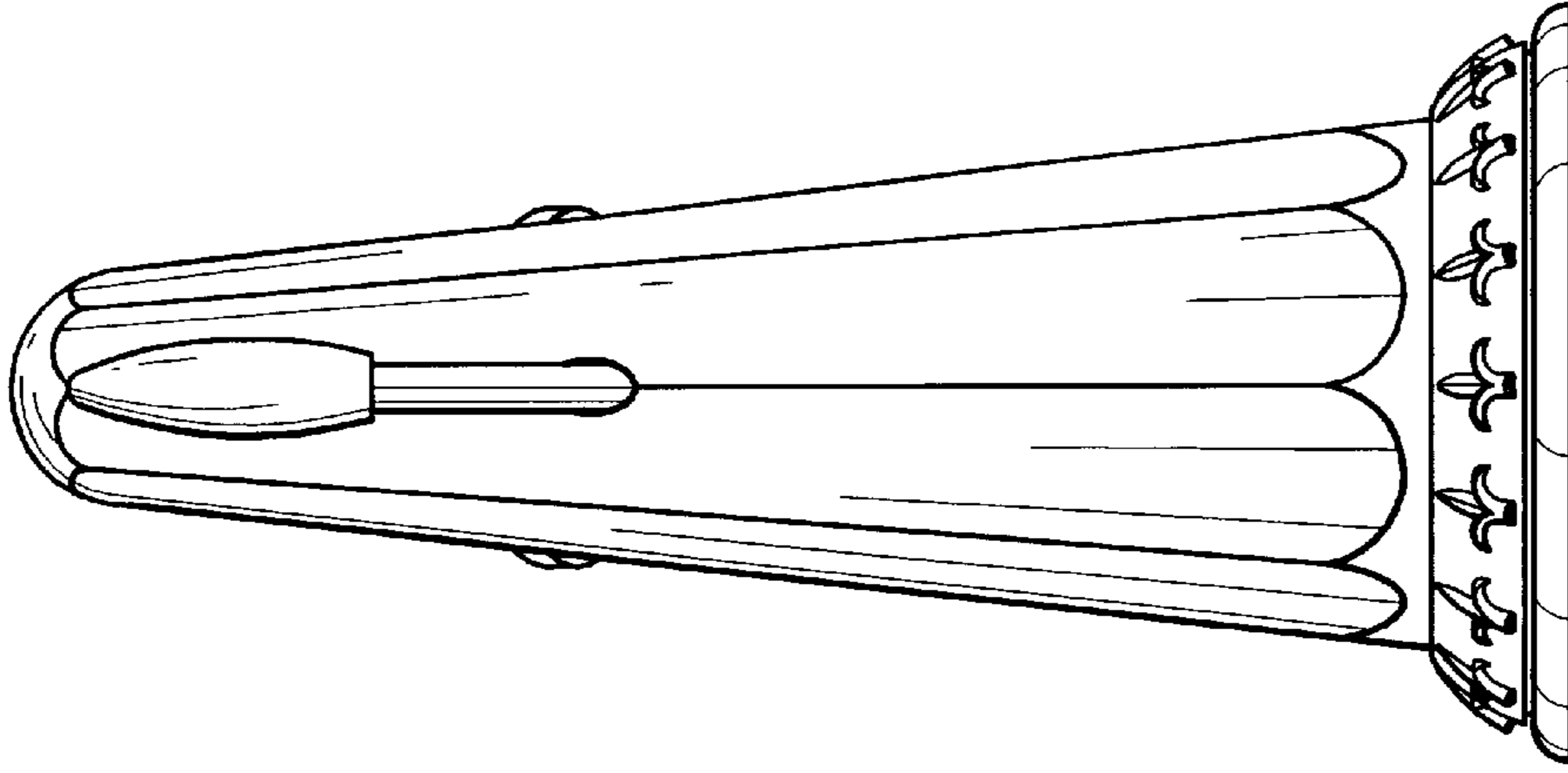

FIG. 3

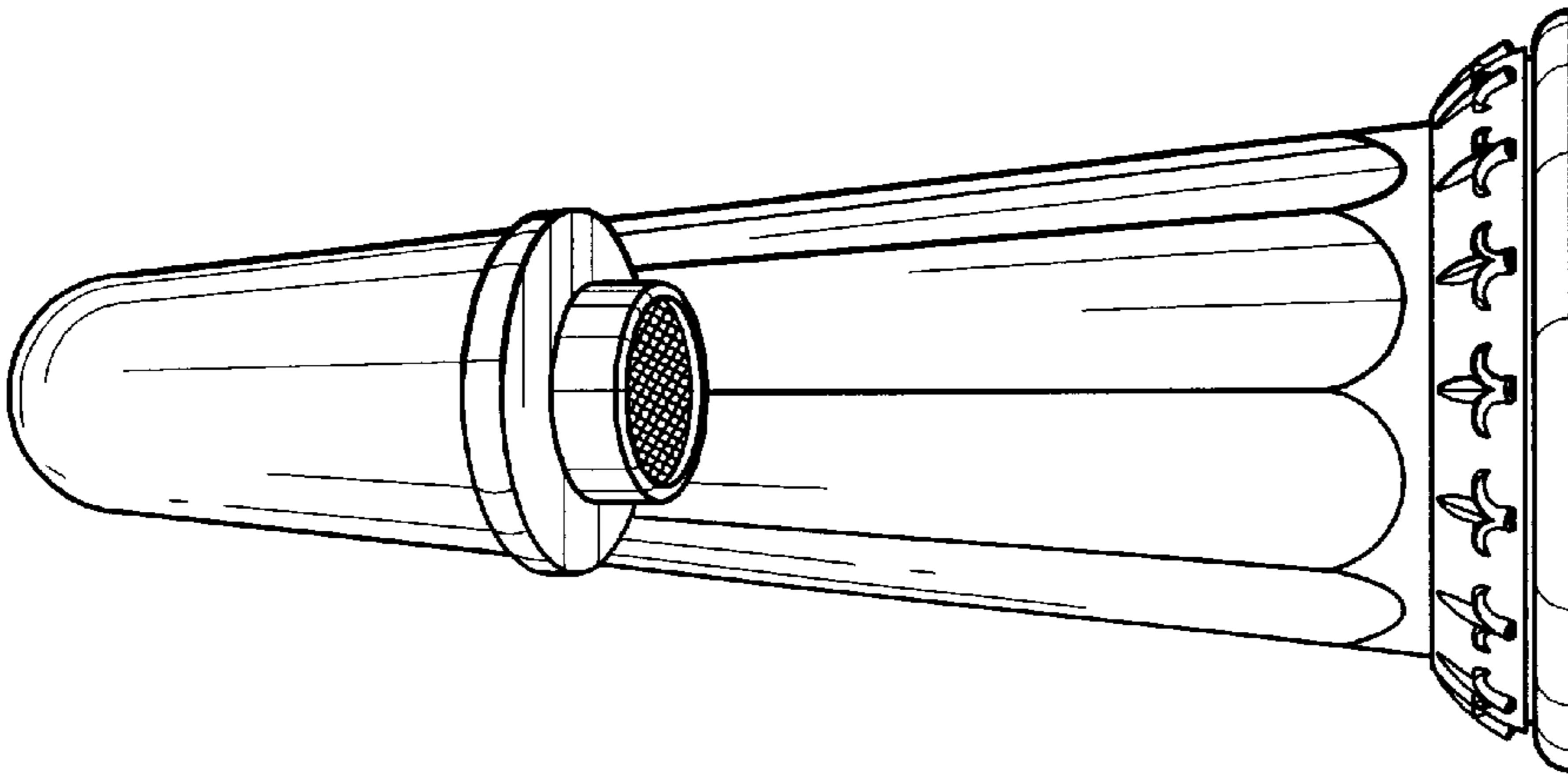

FIG. 2

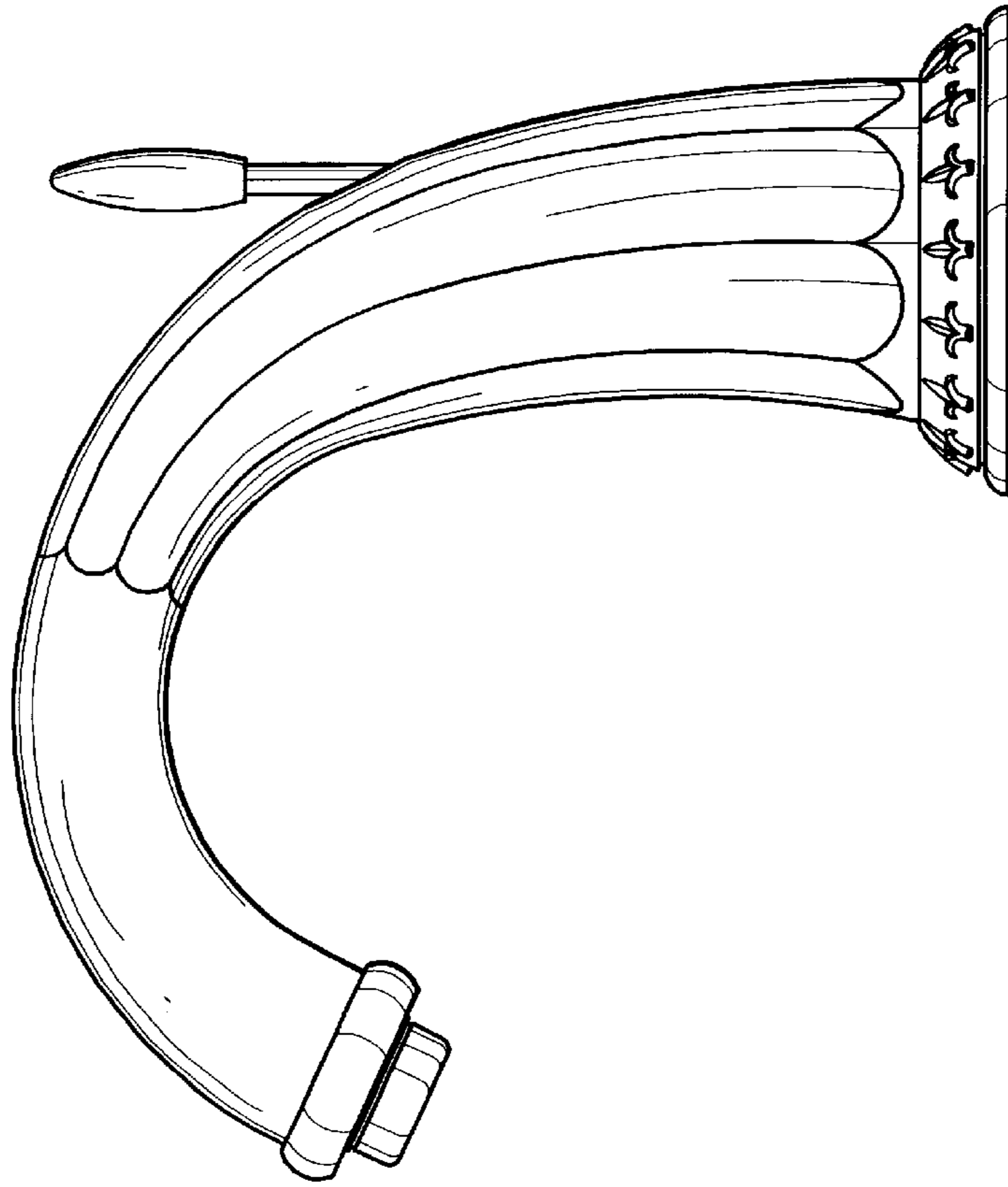

FIG. 5

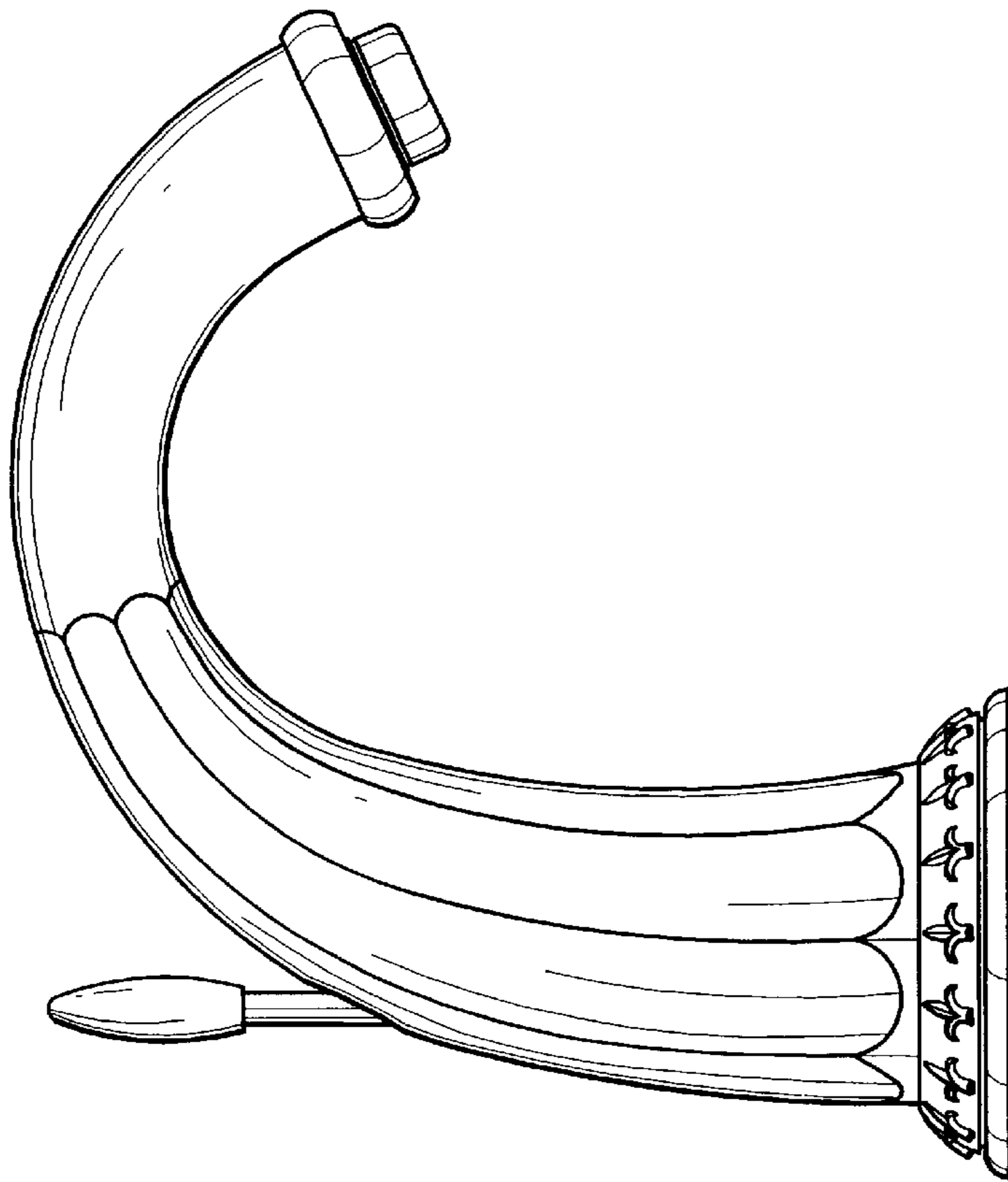

FIG. 4

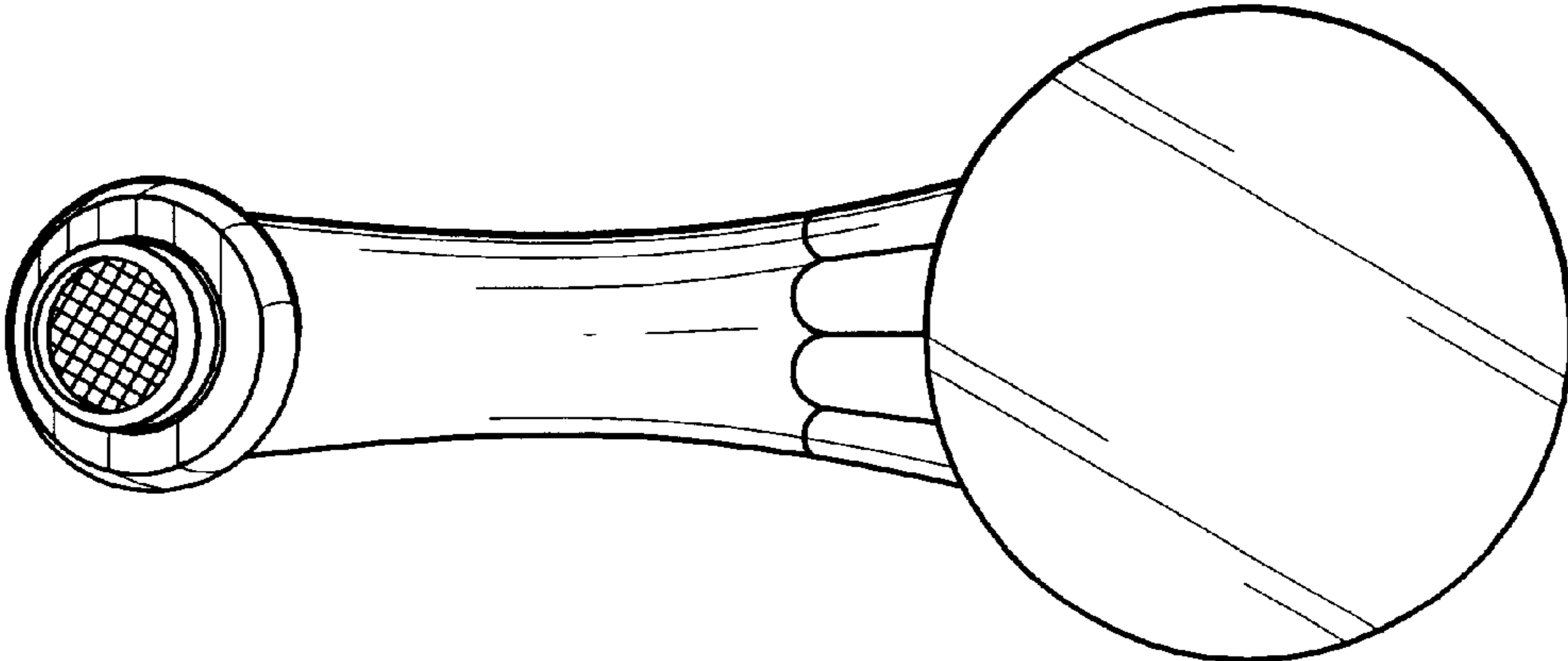

FIG. 7

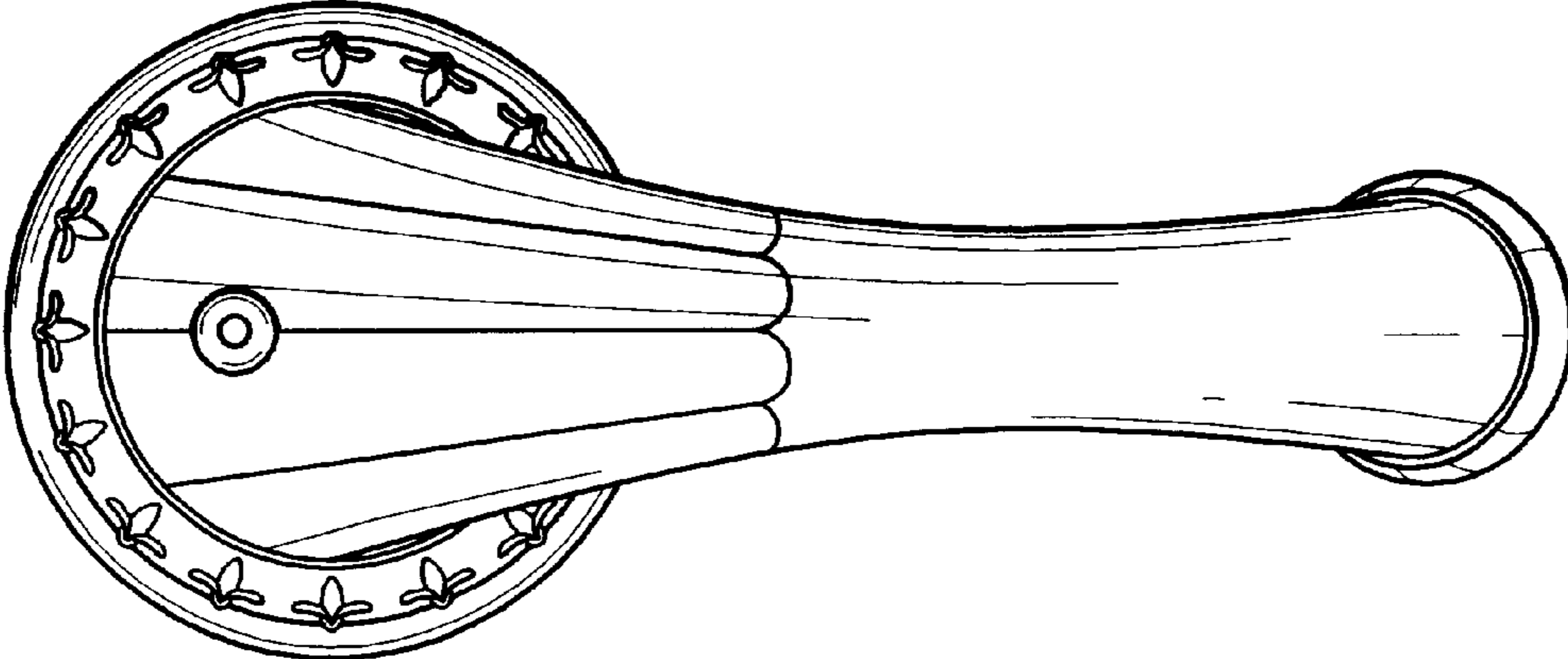

FIG. 6