



US00D516672S

(12) **United States Design Patent**
Khubani et al.

(10) **Patent No.:** **US D516,672 S**
(45) **Date of Patent:** **** Mar. 7, 2006**

(54) **AEROSOL PRODUCT DISPENSER**

(75) Inventors: **Anand Khubani**, Towaco, NJ (US);
Aaron Szymanski, Thomaston, CT (US)

(73) Assignee: **Ideavillage Products Corp.**, Fairfield, NJ (US)

(**) Term: **14 Years**

(21) Appl. No.: **29/214,878**

(22) Filed: **Oct. 7, 2004**

(51) **LOC (8) Cl.** **23-01**

(52) **U.S. Cl.** **D23/223; D23/213**

(58) **Field of Classification Search** **D23/213, D23/223, 226; 239/525, 526, 355**
See application file for complete search history.

(56) **References Cited**

U.S. PATENT DOCUMENTS

- 5,102,052 A * 4/1992 Demarest et al. 239/355
- D459,786 S * 7/2002 Sweeton D23/226
- D499,167 S * 11/2004 Sweeton D23/213
- 6,811,099 B1 * 11/2004 Krestine et al. 239/524

* cited by examiner

Primary Examiner—Robin V. Webster

(74) *Attorney, Agent, or Firm*—Robert L. Epstein, Esq.;
Epstein Drangel Bazerman & James, LLP

(57) **CLAIM**

The ornamental design for an aerosol product dispenser, substantially as shown and described.

DESCRIPTION

FIG. 1 is an isometric view showing the front, top and one side of our invention;

FIG. 2 is an isometric view showing the rear, top and other end of our invention; illustrating how the product containing cannister is received in the dispenser of our invention;

FIG. 3 is an elevational view of one side of our invention, the other side being the mirror image thereof;

FIG. 4 is an elevation view of the front of our invention;

FIG. 5 is an elevation view of the rear of our invention;

FIG. 6 is an elevation view of the top of our invention; and,

FIG. 7 is an elevation view of the bottom of our invention.

The cannister illustrated in dot and dash does not constitute a part of the invention.

1 Claim, 5 Drawing Sheets

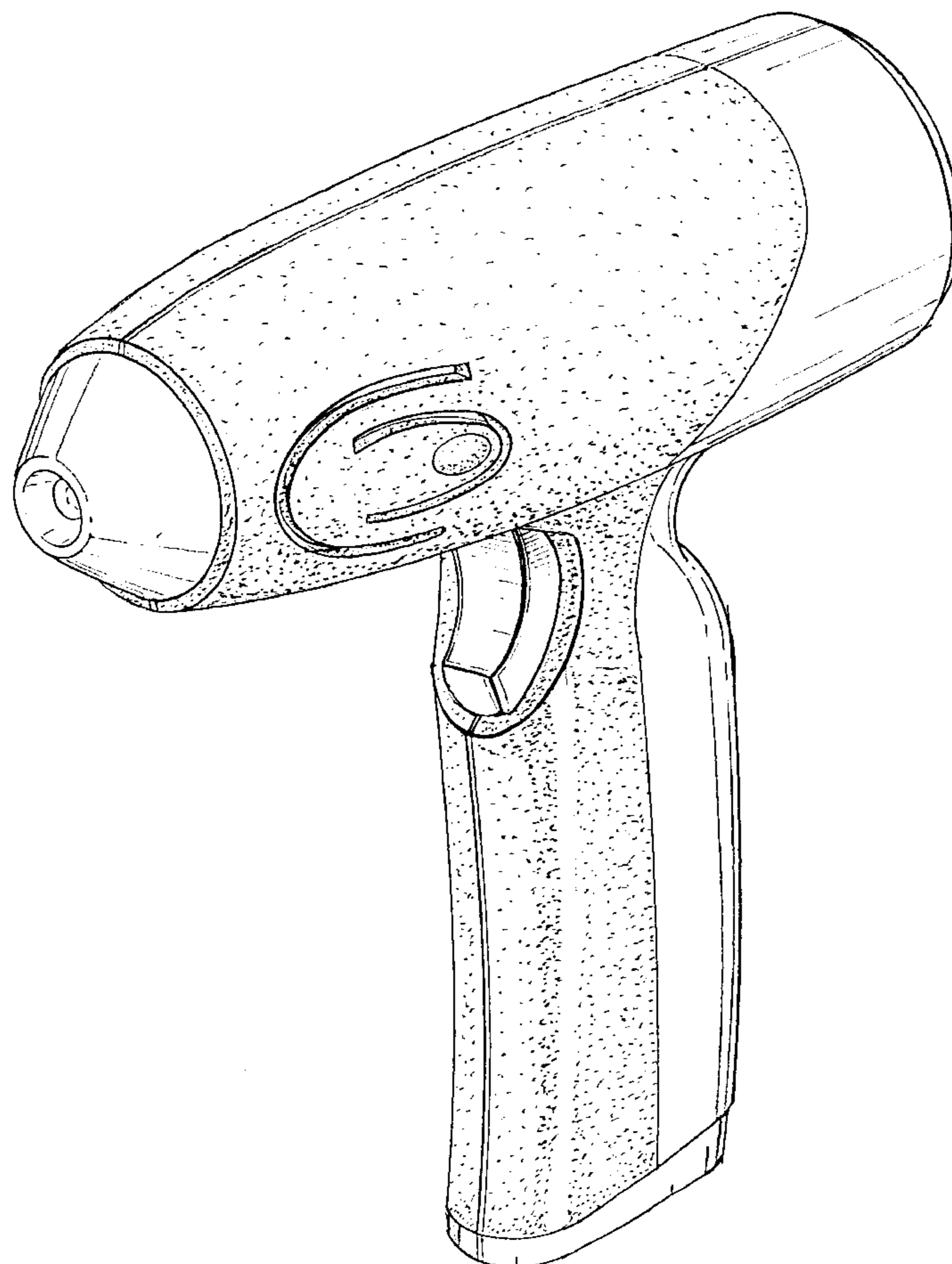

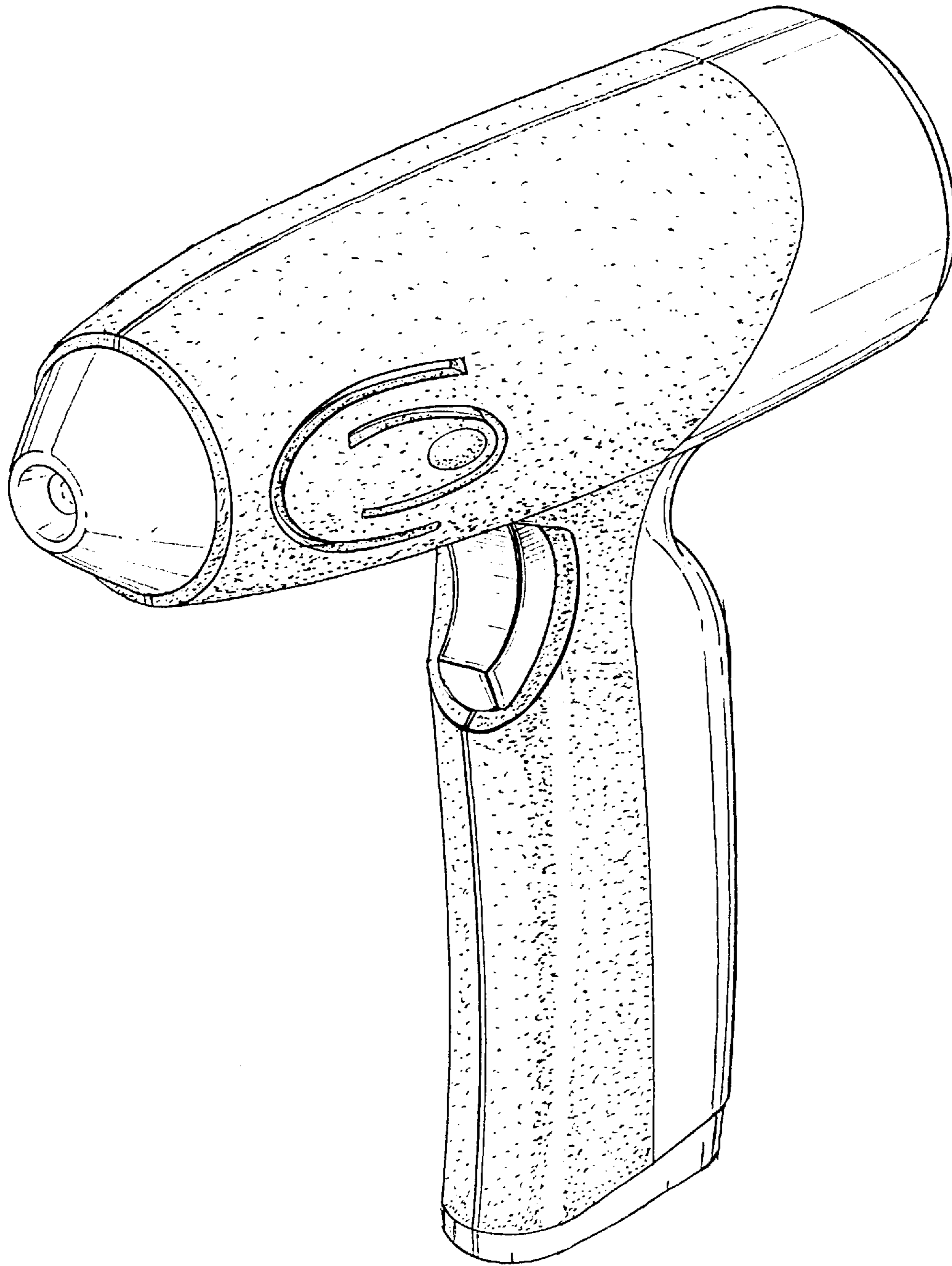

FIG. 1

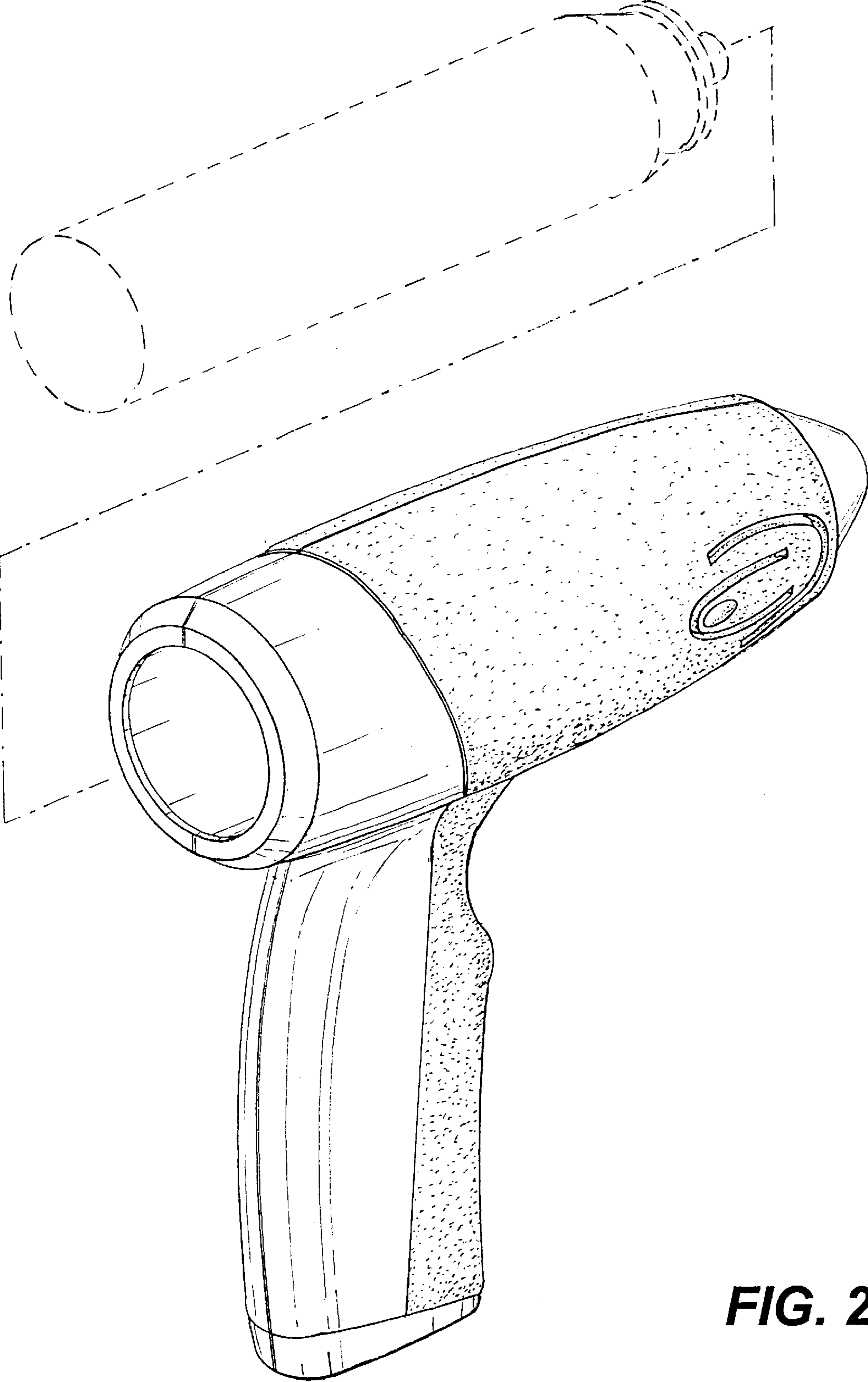

FIG. 2

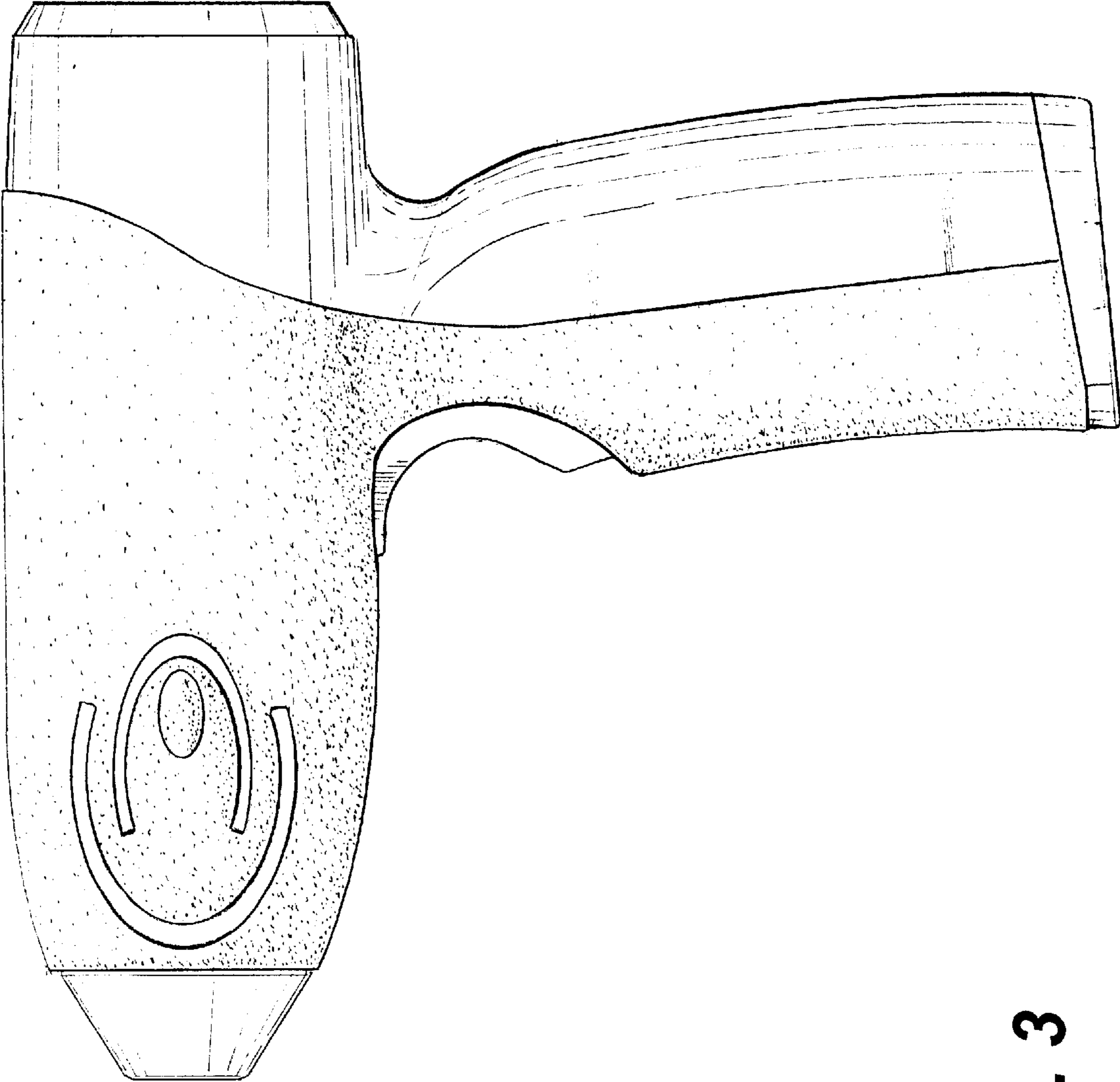

FIG. 3

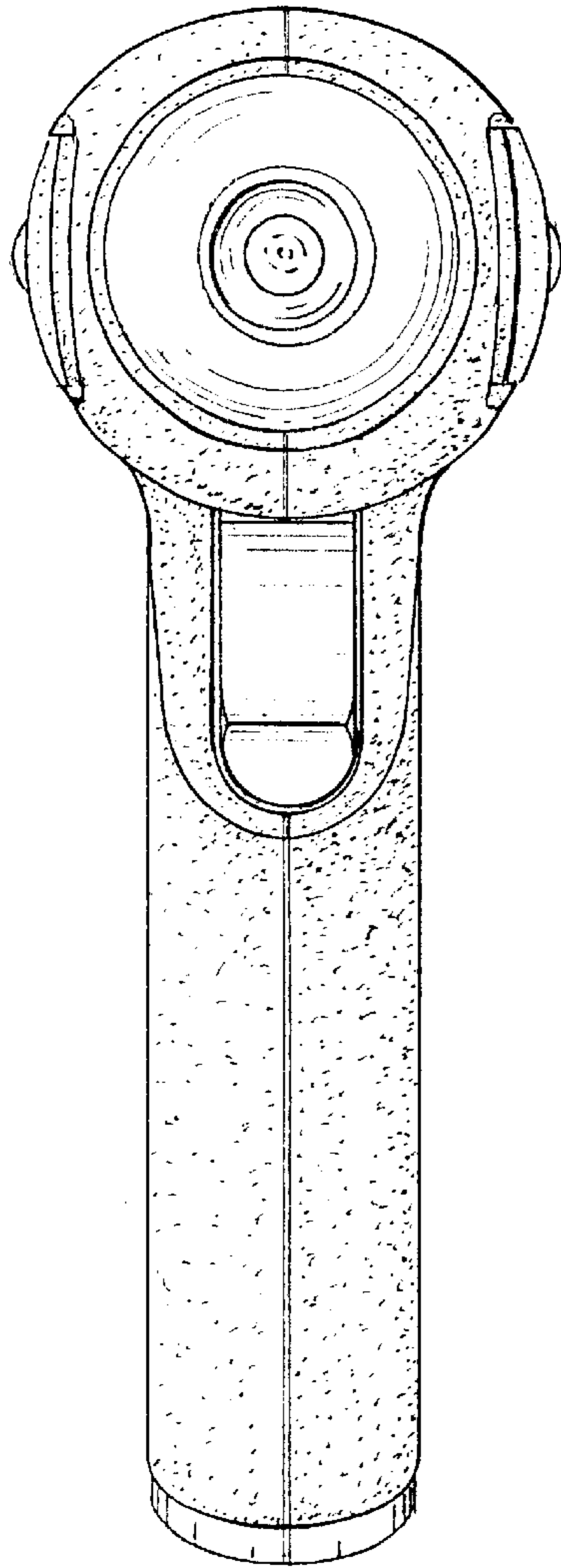

FIG. 4

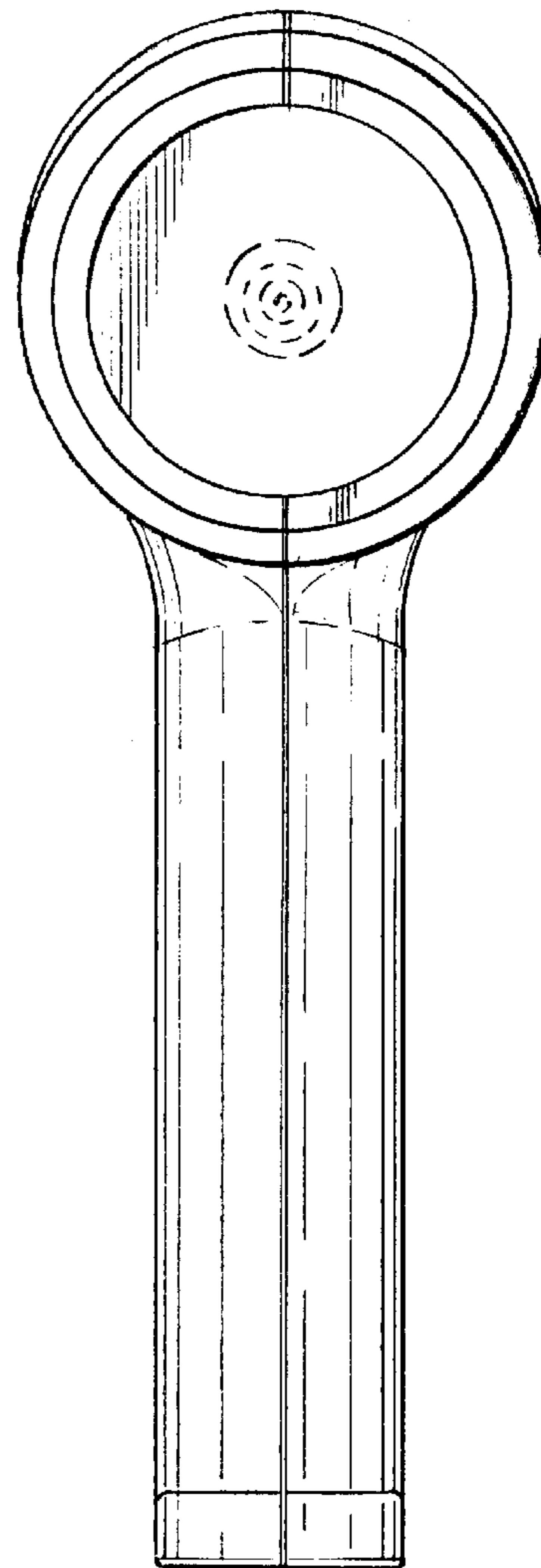

FIG. 5

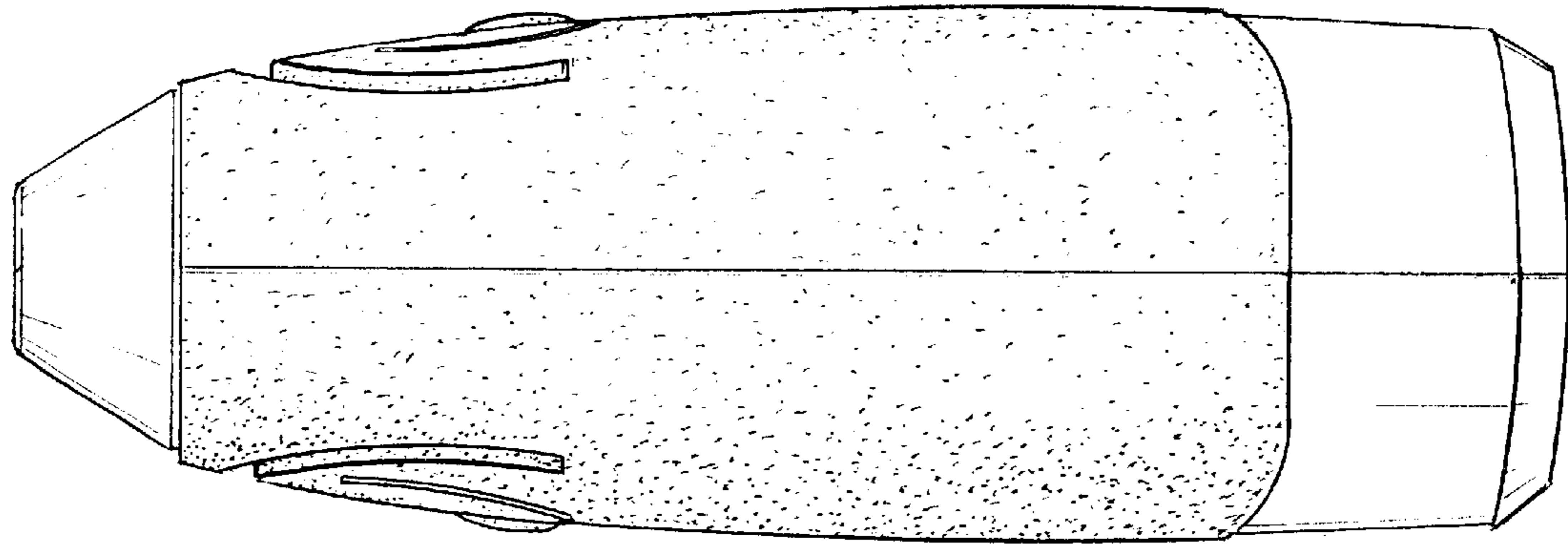

FIG. 6

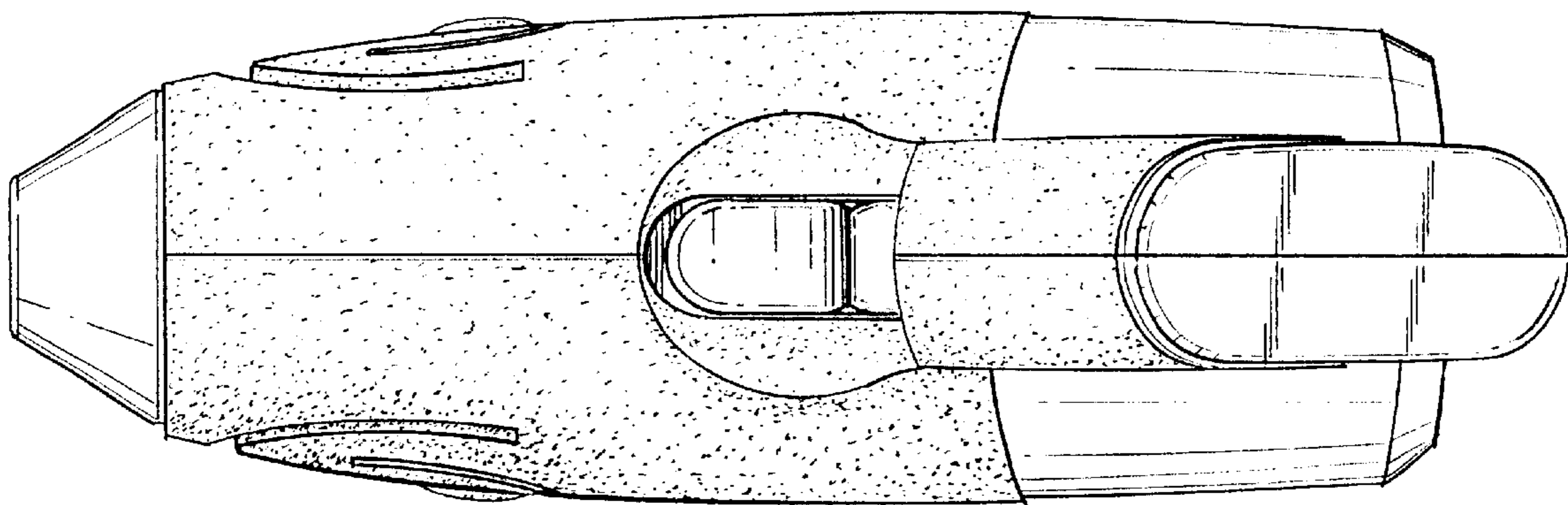

FIG. 7