

US00D51666S

(12) **United States Design Patent**
Goran

(10) **Patent No.:** **US D516,666 S**
(45) **Date of Patent:** **** Mar. 7, 2006**

(54) **MAGNETIC DEVICE FOR TREATMENT OF FLUIDS**

(76) Inventor: **Dave Goran**, 621 Applegate La., Grand Blanc, MI (US) 48439

(**) Term: **14 Years**

(21) Appl. No.: **29/218,013**

(22) Filed: **Nov. 24, 2004**

(51) **LOC (8) Cl.** **23-01**

(52) **U.S. Cl.** **D23/207**

(58) **Field of Classification Search** D23/207,
D23/209; 210/222, 223

See application file for complete search history.

(56) **References Cited**

U.S. PATENT DOCUMENTS

D289,674 S	*	5/1987	Kulish	D23/207
D299,266 S	*	1/1989	Kulish	D23/207
6,758,968 B2	*	7/2004	Ashton	210/222

* cited by examiner

Primary Examiner—Robin V. Webster

(74) *Attorney, Agent, or Firm*—Gifford, Krass, Groh, Sprinkle, Anderson & Citkowski, P.C.

(57) **CLAIM**

I claim the ornamental design for a magnetic device for treatment of fluids, as shown and described.

DESCRIPTION

FIG. 1 is a top planar view of a first embodiment of the magnetic device for treatment of fluids of my present design;

FIG. 2 is a planar view of a side of the device shown in FIG. 1, the opposite side being a mirror image thereof;

FIG. 3 is a top planar view of a second embodiment of the magnetic device for treatment of fluids of my present design;

FIG. 4 is a planar view of a side of the device shown in FIG. 3, the opposite side being a mirror image thereof;

FIG. 5 is a top planar view of a third embodiment of the magnetic device for treatment of fluids of my present design;

FIG. 6 is a planar view of a side of the device shown in FIG. 5, the opposite side being a mirror image thereof;

FIG. 7 is a top planar view of a fourth embodiment of the magnetic device for treatment of fluids of my present design;

FIG. 8 is a planar view of a side of the device shown in FIG. 7, the opposite side being a mirror image thereof;

FIG. 9 is a top planar view of a fifth embodiment of the magnetic device for treatment of fluids of my present design;

FIG. 10 is a planar view of a side of the device shown in FIG. 9, the opposite side being a mirror image thereof;

FIG. 11 is a top planar view of a sixth embodiment of the magnetic device for treatment of fluids of my present design; and,

FIG. 12 is a planar view of a side of the device shown in FIG. 11, the opposite side being a mirror image thereof.

1 Claim, 3 Drawing Sheets

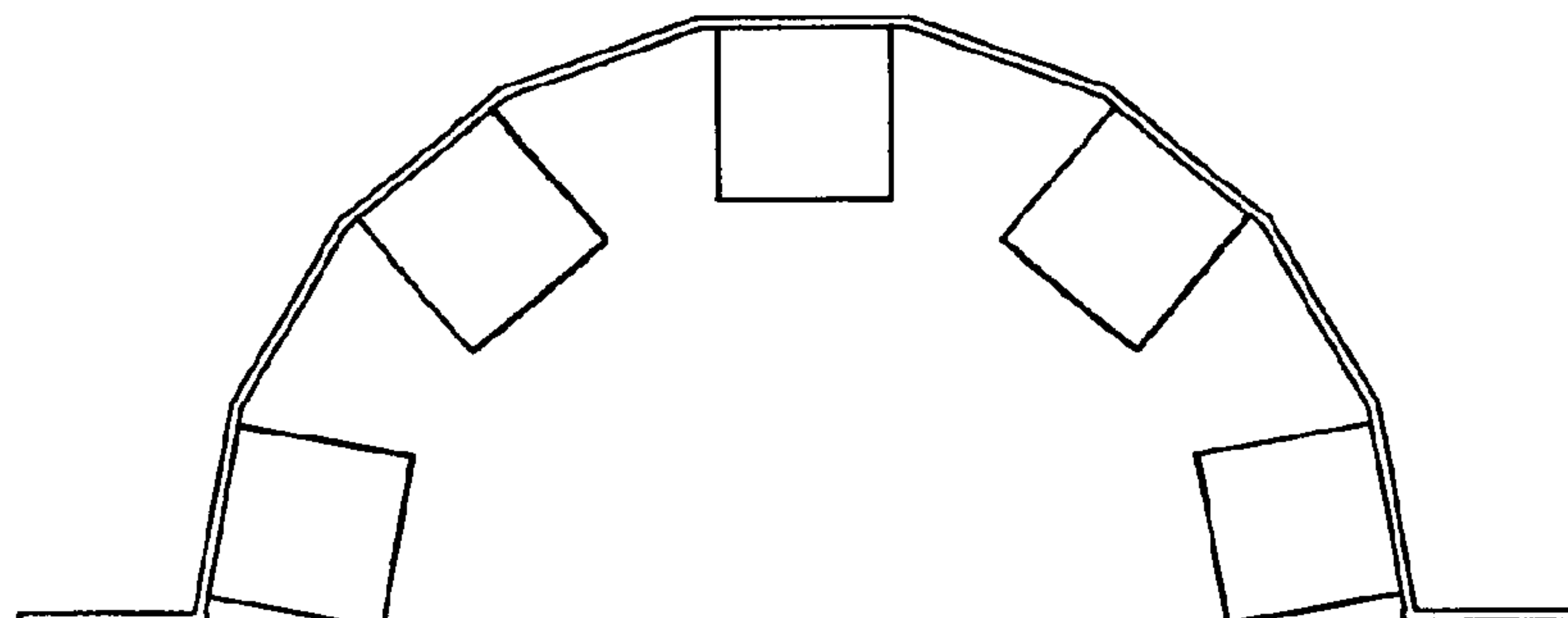
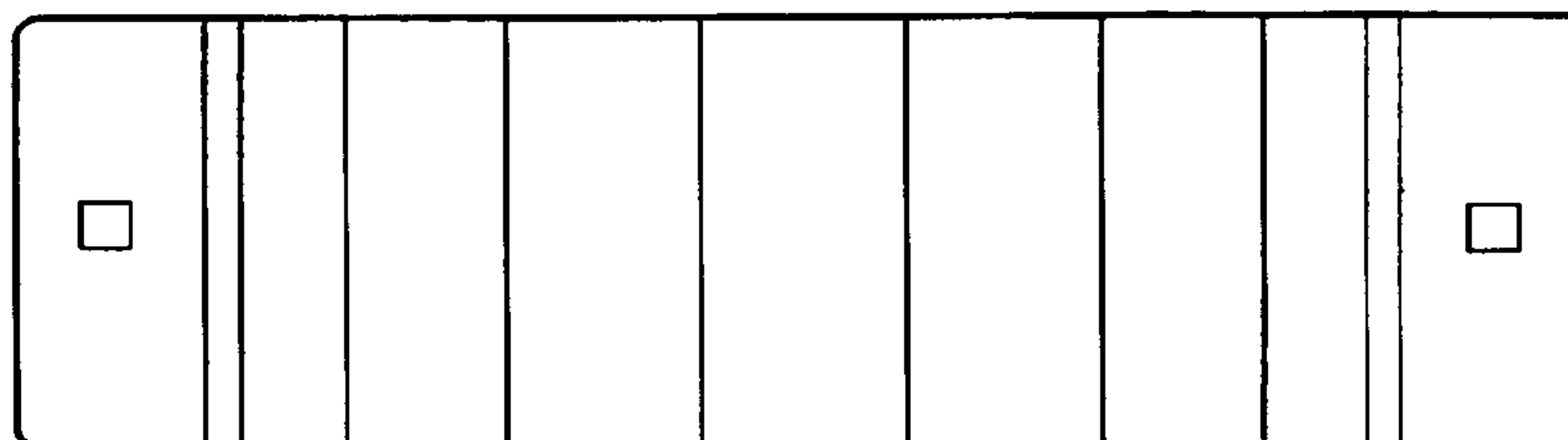

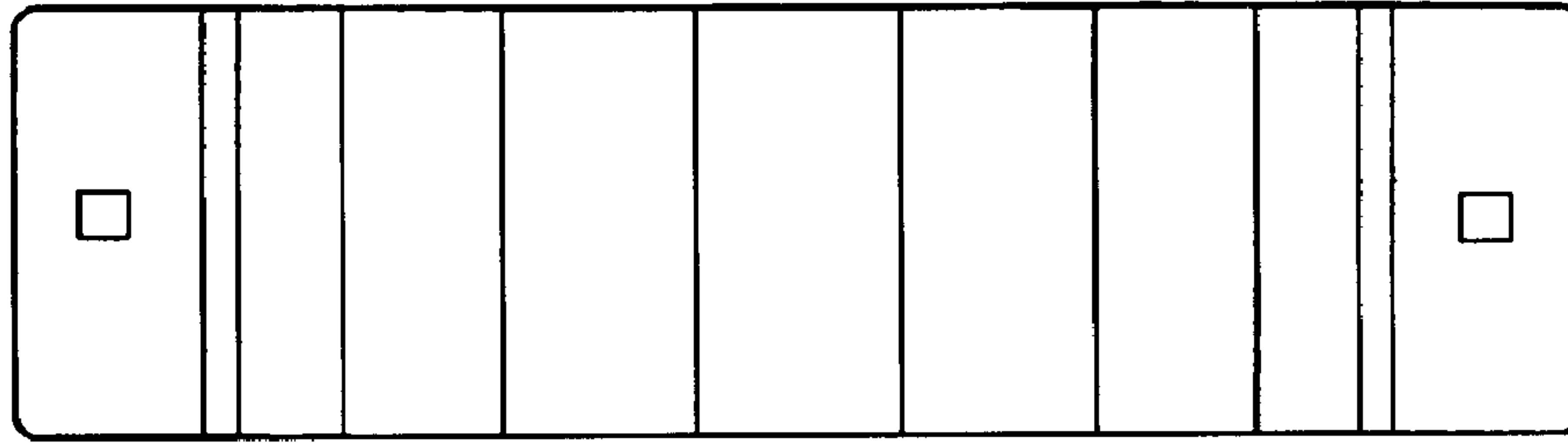

Fig-1

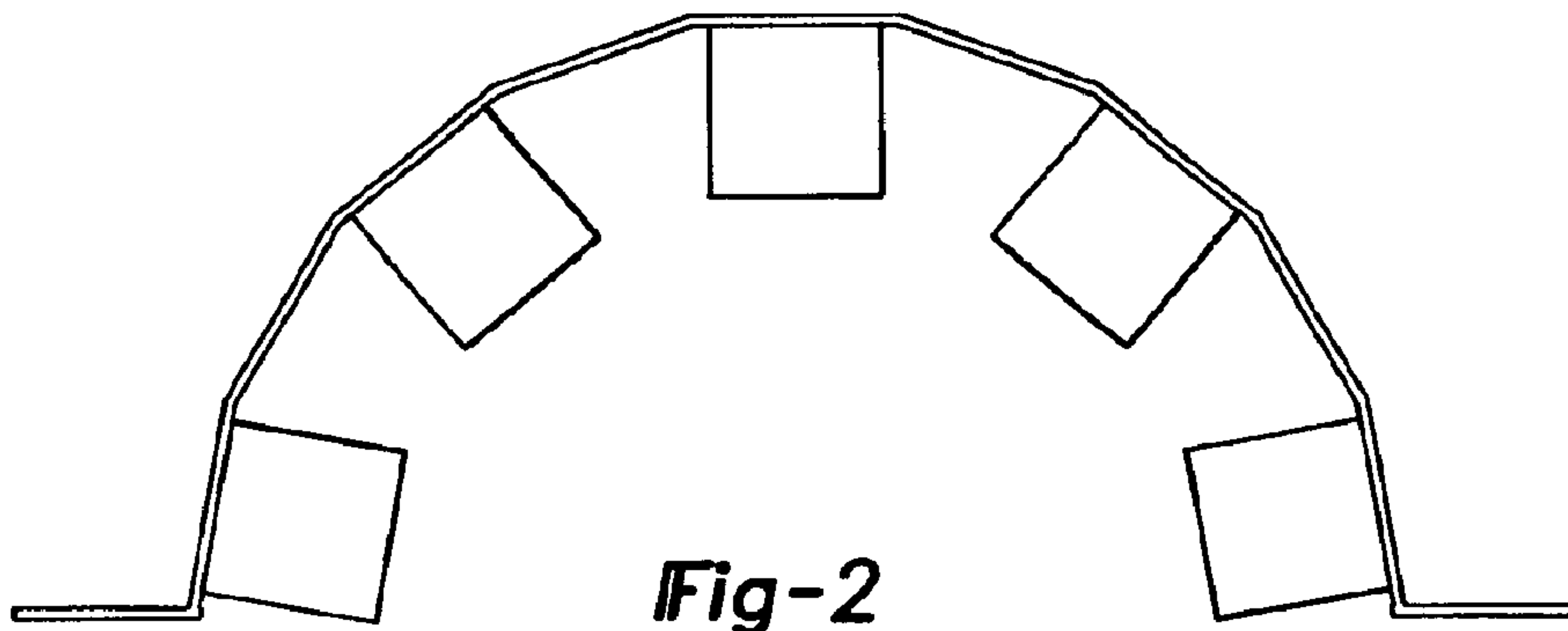

Fig-2

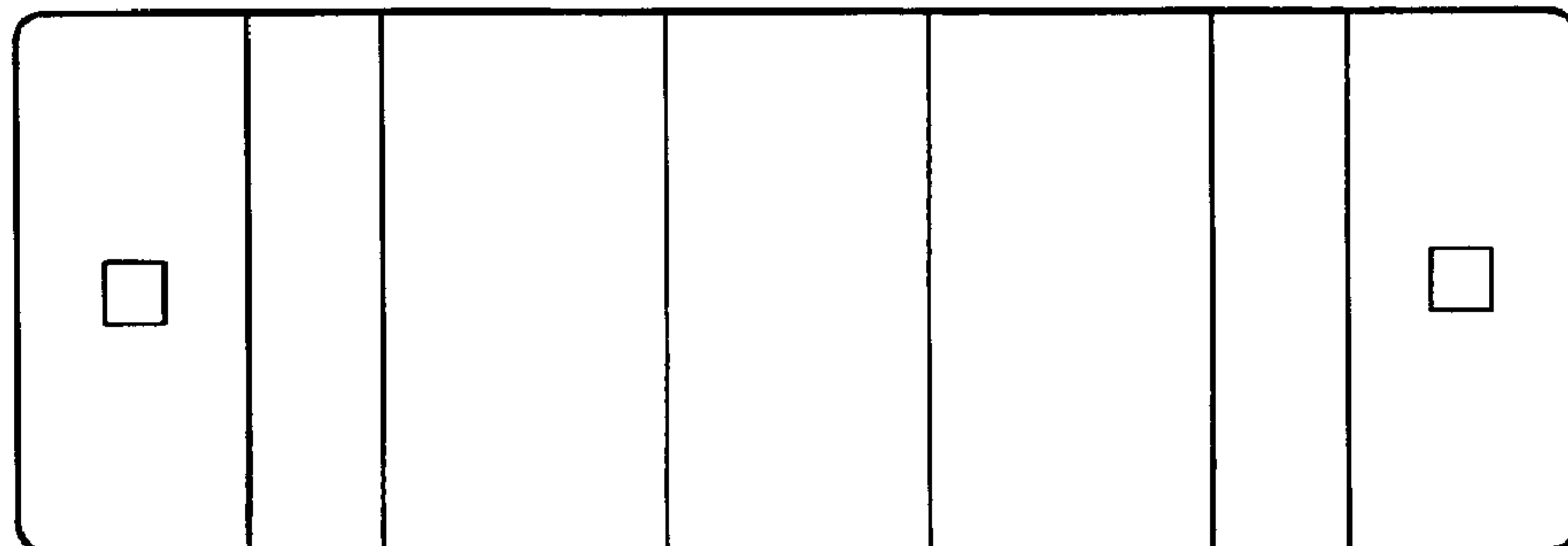

Fig-3

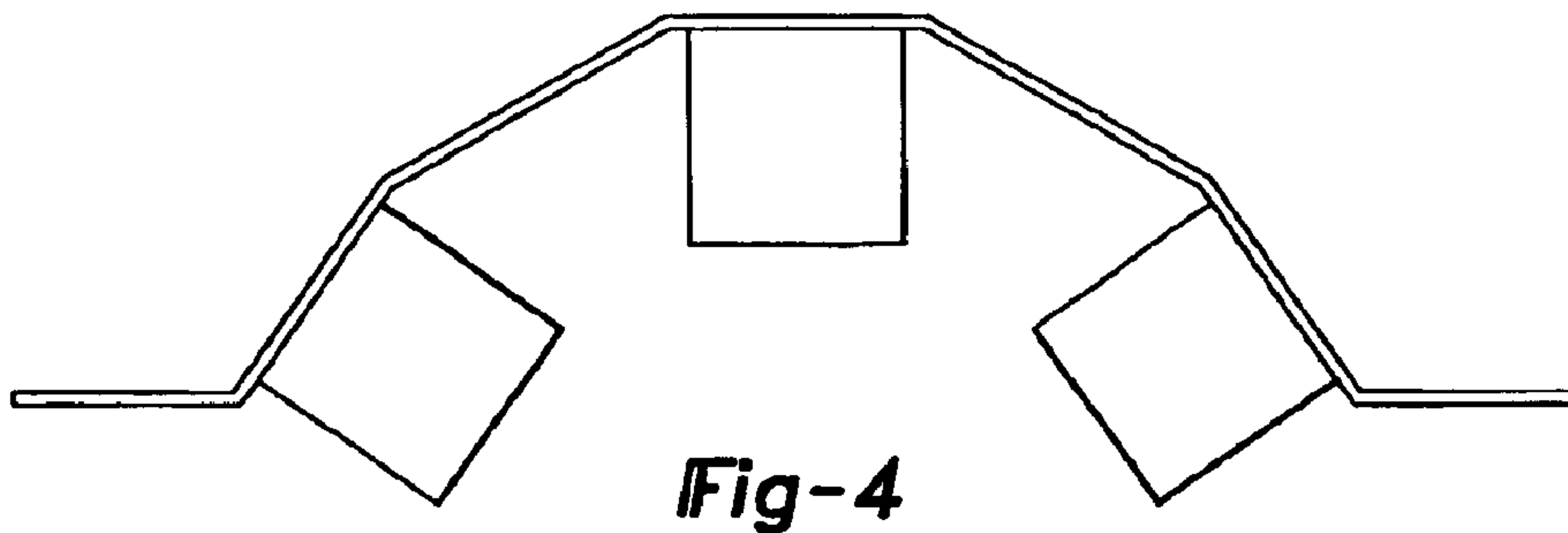

Fig-4

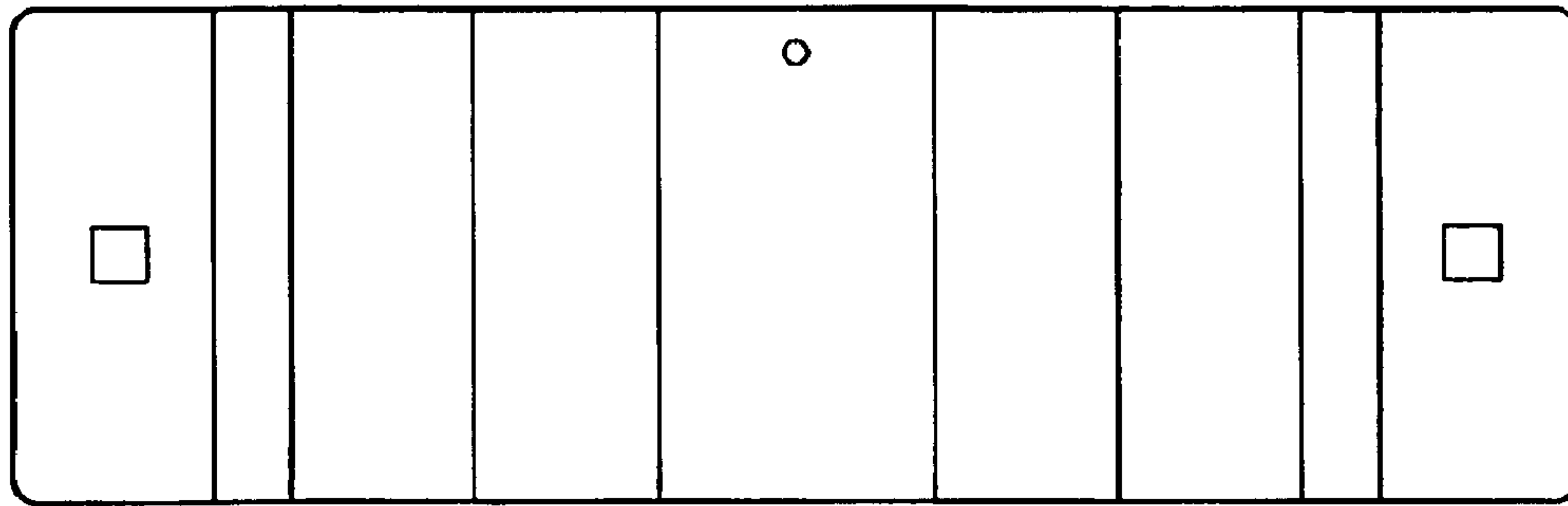

Fig-5

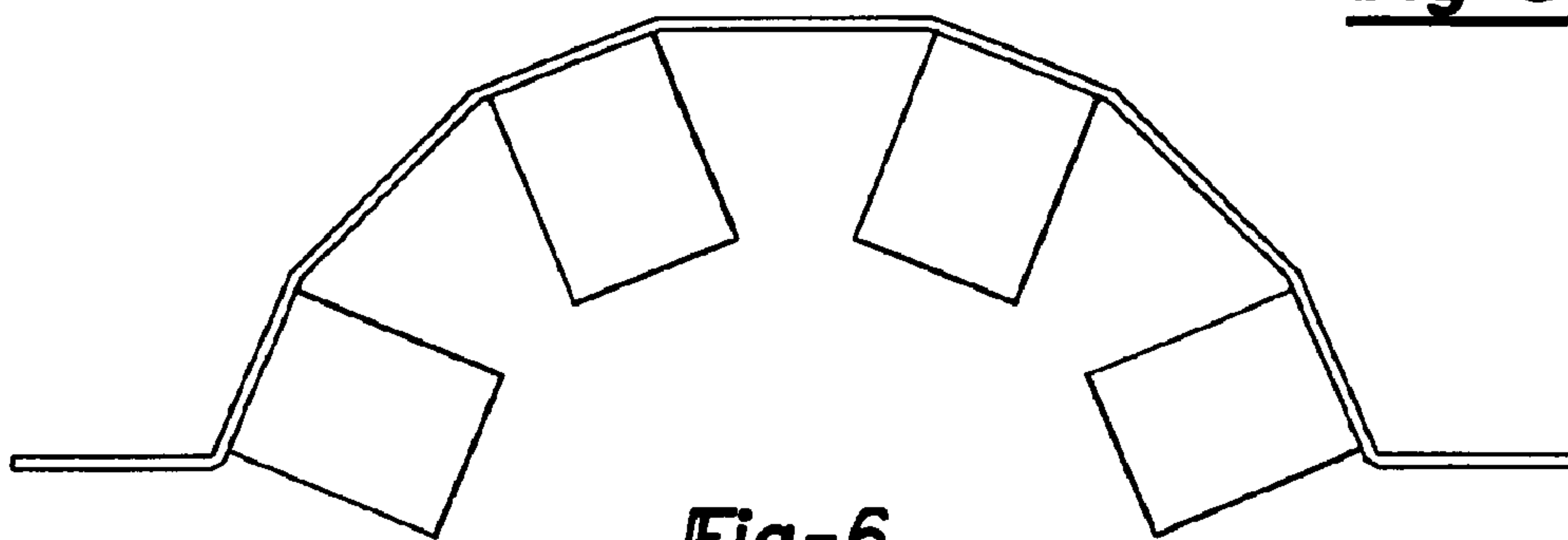

Fig-6

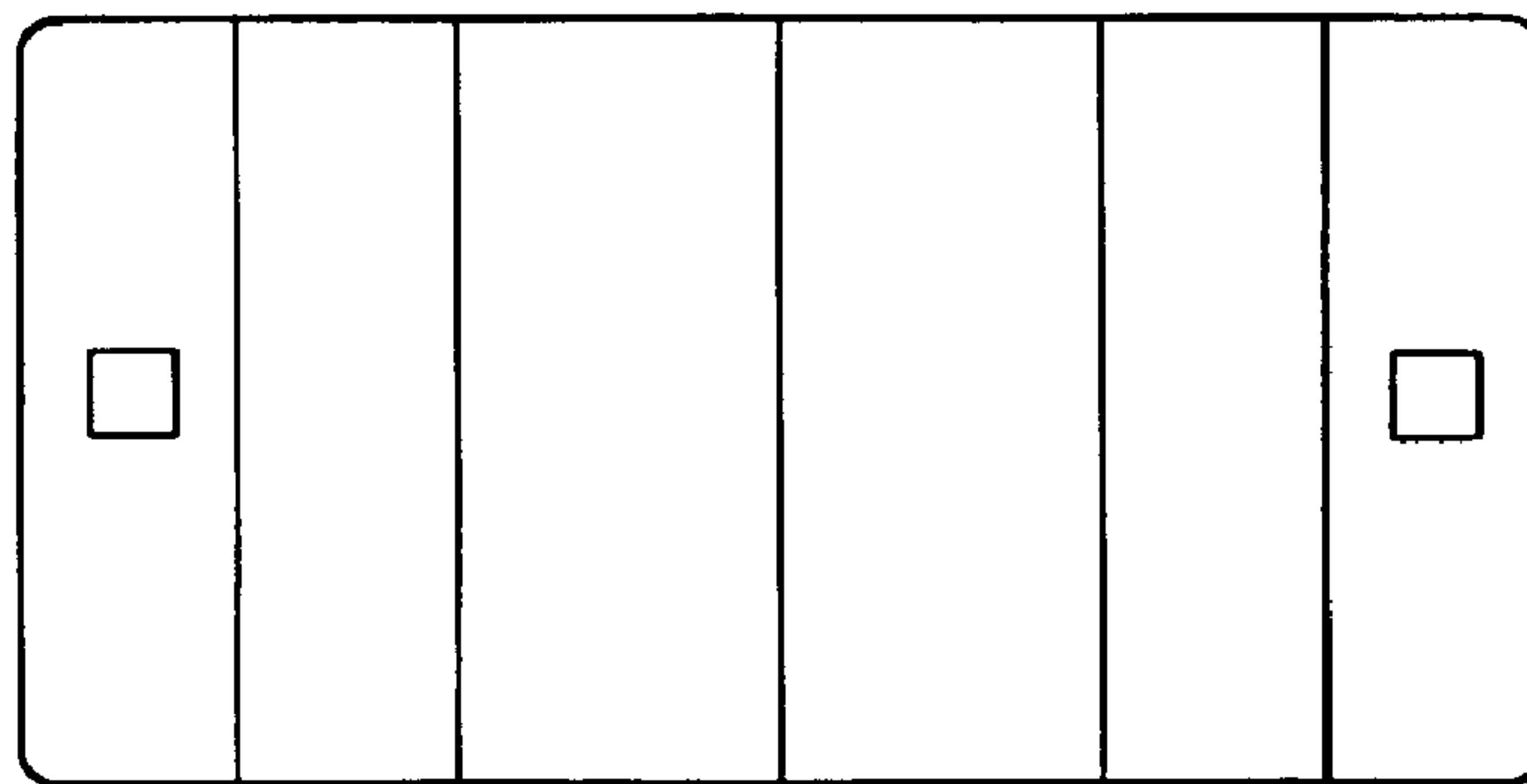

Fig-7

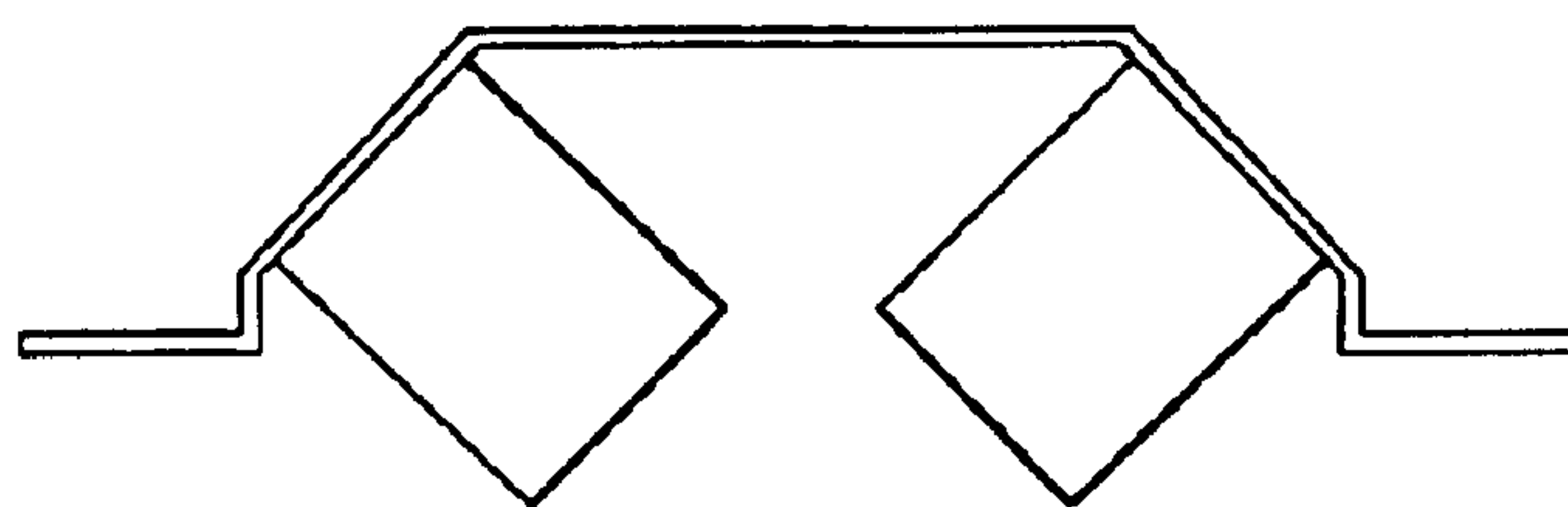

Fig-8

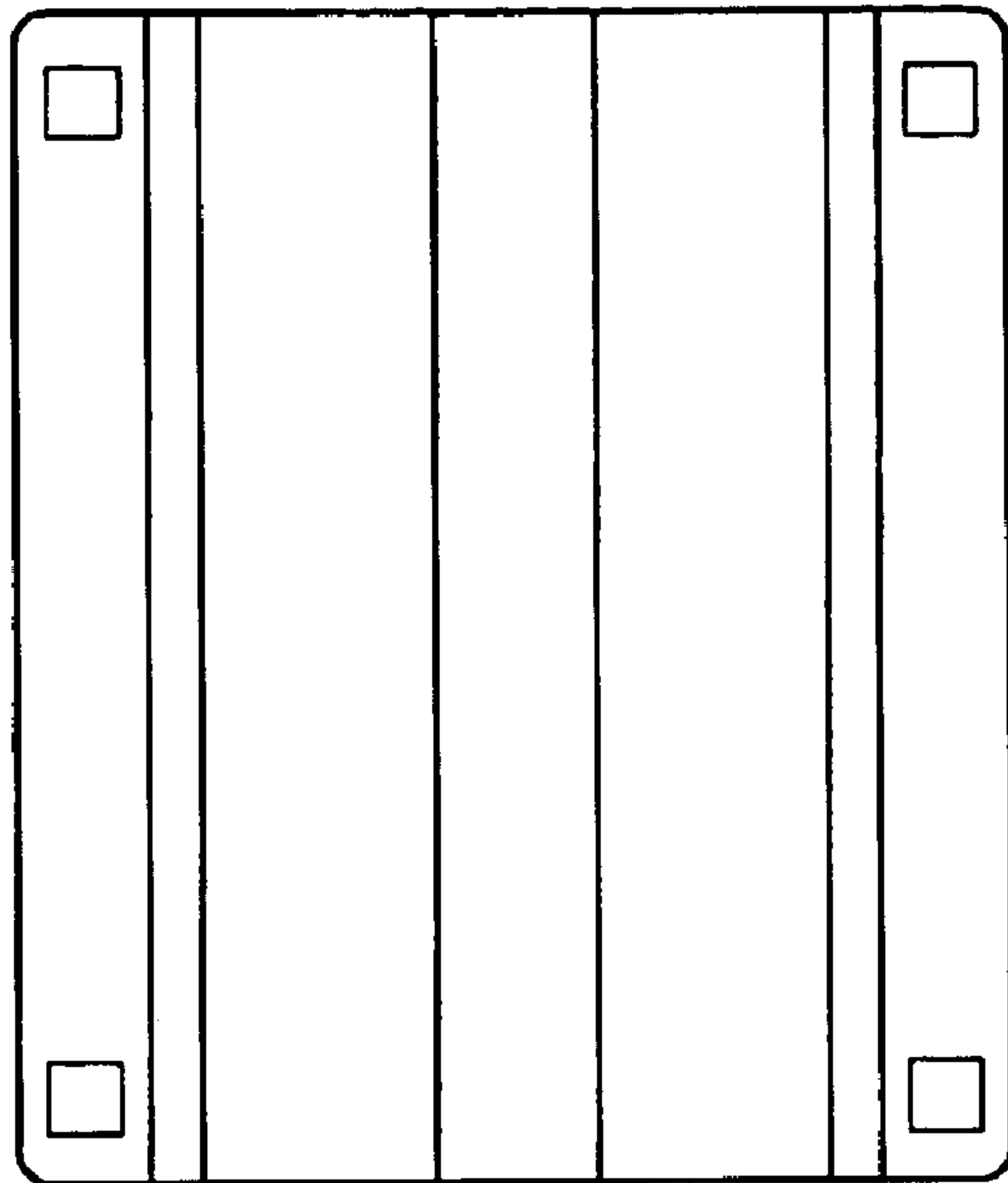

Fig-9

Fig-10

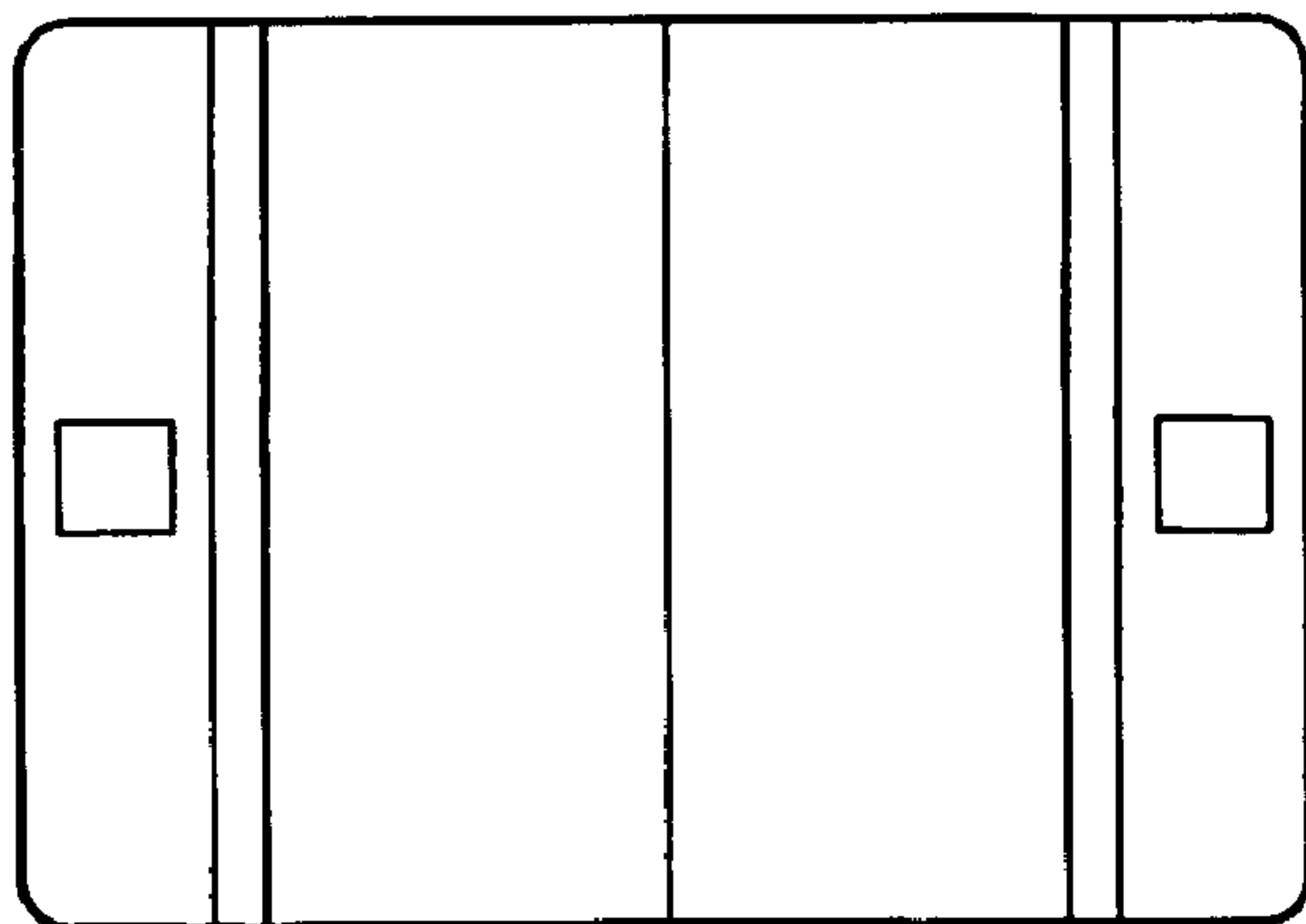
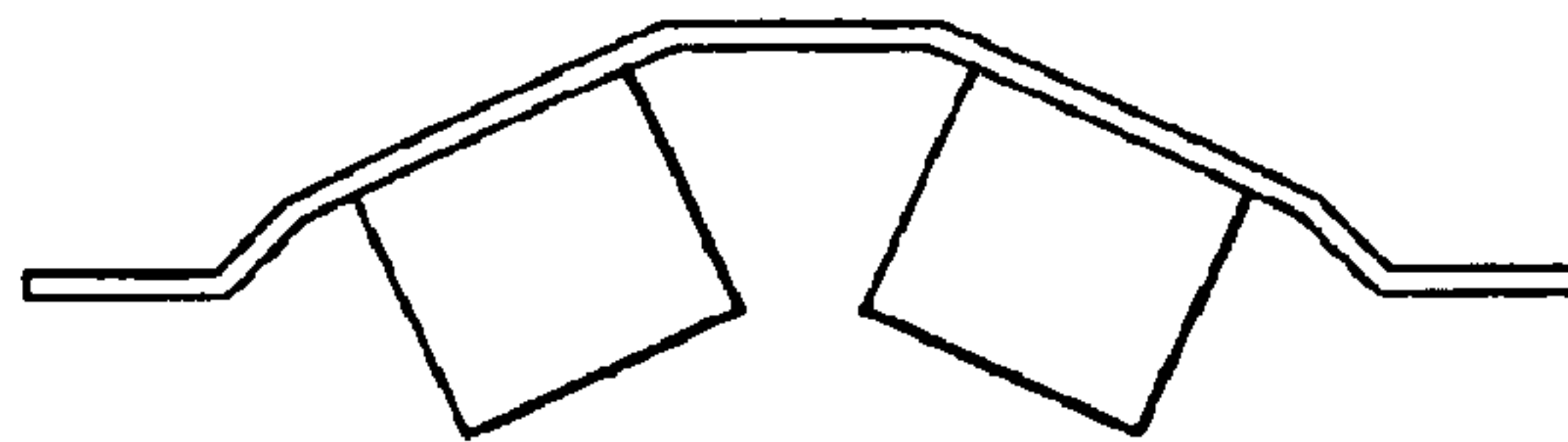

Fig-11

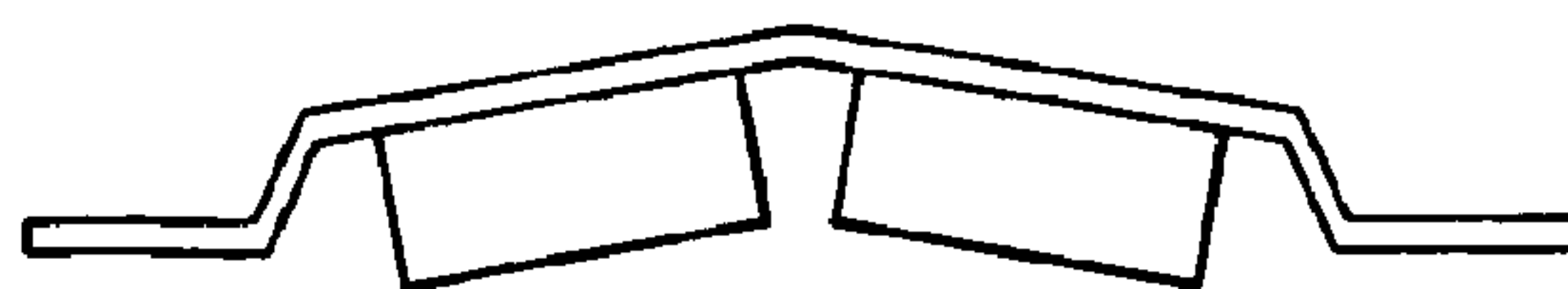

Fig-12