



US00D516664S

(12) **United States Design Patent**  
**Iwabuchi**

(10) **Patent No.:** **US D516,664 S**  
(45) **Date of Patent:** **\*\* Mar. 7, 2006**

(54) **FISHING REEL REEL UNIT**

(75) Inventor: **Masakazu Iwabuchi**, Tondabayashi (JP)

(73) Assignee: **Shimano Inc.**, Osaka (JP)

(\*\*) Term: **14 Years**

(21) Appl. No.: **29/218,376**

(22) Filed: **Dec. 2, 2004**

(30) **Foreign Application Priority Data**

Jun. 2, 2004 (JP) ..... 2004-016360

(51) **LOC (8) Cl.** ..... **22-05**

(52) **U.S. Cl.** ..... **D22/141**

(58) **Field of Classification Search** ..... D22/141,  
D22/140, 137-139; 242/370, 223, 224, 234-240,  
242/311, 322

See application file for complete search history.

(56) **References Cited**

**U.S. PATENT DOCUMENTS**

5,433,394 A	*	7/1995	Brozio	.....	D22/140
D424,657 S	*	5/2000	Kang et al.	.....	D22/141
D433,728 S	*	11/2000	Tao	.....	D22/141
D437,026 S	*	1/2001	Tao	.....	D22/141
D460,516 S	*	7/2002	Yoshikawa et al.	.....	D22/141
D467,299 S	*	12/2002	Kondo et al.	.....	D22/141
D491,249 S	*	6/2004	Burke et al.	.....	D22/140
D505,710 S	*	5/2005	Kitazaki	.....	D22/141
D506,524 S	*	6/2005	Kitazaki	.....	D22/141

\* cited by examiner

*Primary Examiner*—Catherine R. Oliver

(74) *Attorney, Agent, or Firm*—Shinju Global IP Counselors, IP

(57) **CLAIM**

The ornamental design for a fishing reel reel unit, as shown and described.

**DESCRIPTION**

FIG. 1 is a front view of a fishing reel reel unit in accordance with my new design;

FIG. 2 is a rear view of the fishing reel reel unit in accordance with my new design;

FIG. 3 is a left side view of the fishing reel reel unit in accordance with my new design;

FIG. 4 is a right side view of the fishing reel reel unit in accordance with my new design;

FIG. 5 is a top plan view of the fishing reel reel unit in accordance with my new design;

FIG. 6 is a bottom plan view of the fishing reel reel unit in accordance with my new design;

FIG. 7 is a left upper side perspective view of the fishing reel reel unit in accordance with my new design;

FIG. 8 is a left bottom side perspective view of the fishing reel reel unit in accordance with my new design;

FIG. 9 is a cross sectional view of the fishing reel reel unit in accordance with my new design in accordance with my new design as viewed in a direction of the arrow 9—9 in FIG. 1;

FIG. 10 is a cross sectional view of the fishing reel reel unit in accordance with my new design in accordance with my new design as viewed in a direction of the arrow 10—10 in FIG. 3;

FIG. 11 is a cross sectional view of the fishing reel reel unit in accordance with my new design in accordance with my new design as viewed in a direction of the arrow 11—11 in FIG. 3;

FIG. 12 is a cross sectional view of the fishing reel reel unit in accordance with my new design in accordance with my new design as viewed in a direction of the arrow 12—12 in FIG. 3;

FIG. 13 is a cross sectional view of the fishing reel reel unit in accordance with my new design in accordance with my new design as viewed in a direction of the arrow 13—13 in FIG. 3; and,

FIG. 14 is a cross sectional view of the fishing reel reel unit in accordance with my new design in accordance with my new design as viewed in a direction of the arrow 14—14 in FIG. 3.

The broken line showing of environment (the remaining structure of the fishing reel) in the Figures is for illustrative purposes only and forms no part of the claimed design. Moreover, the inner surface of the fishing reel reel unit does not form part of the claimed design.

**1 Claim, 7 Drawing Sheets**

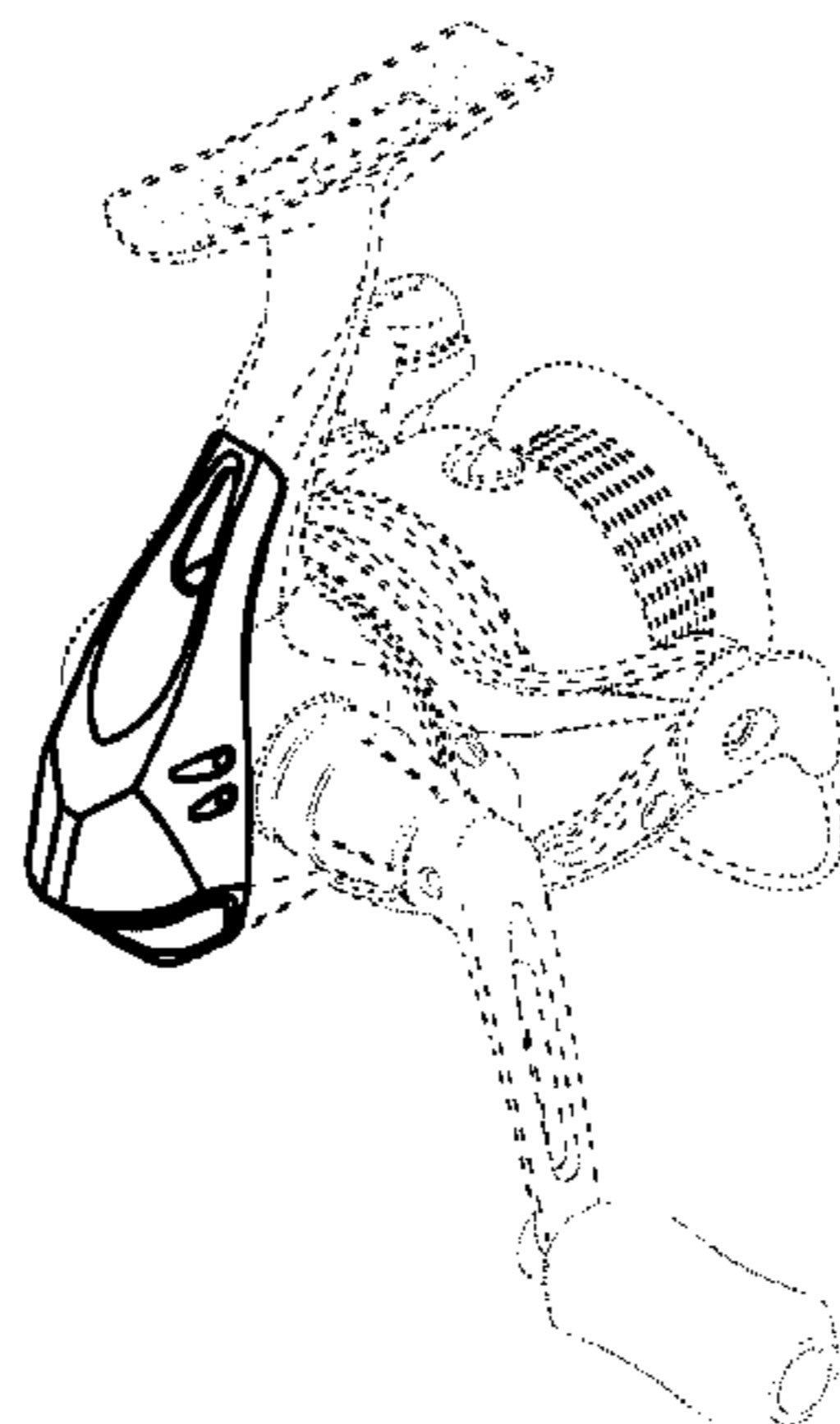

FIGURE 1

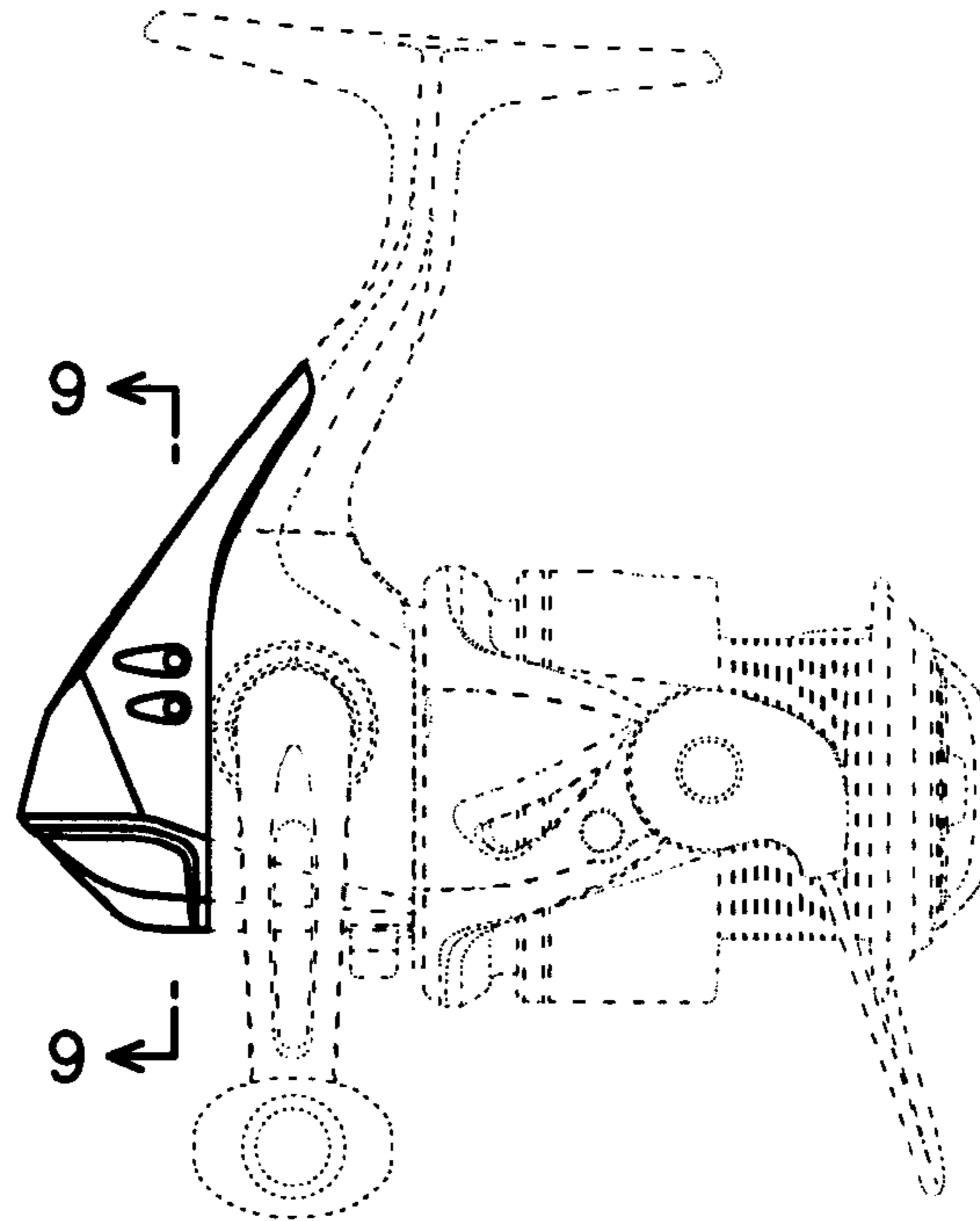

FIGURE 2

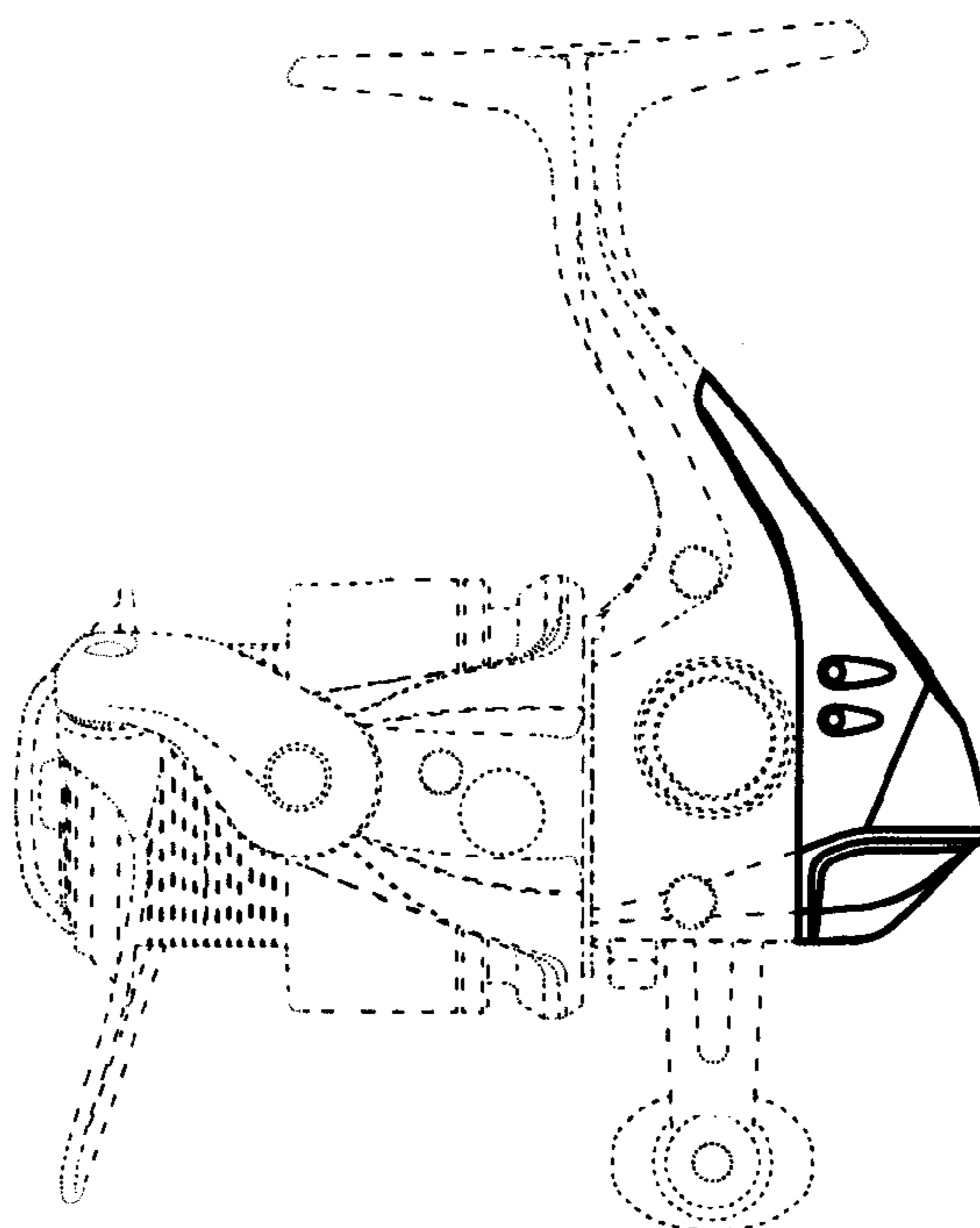

FIGURE 3

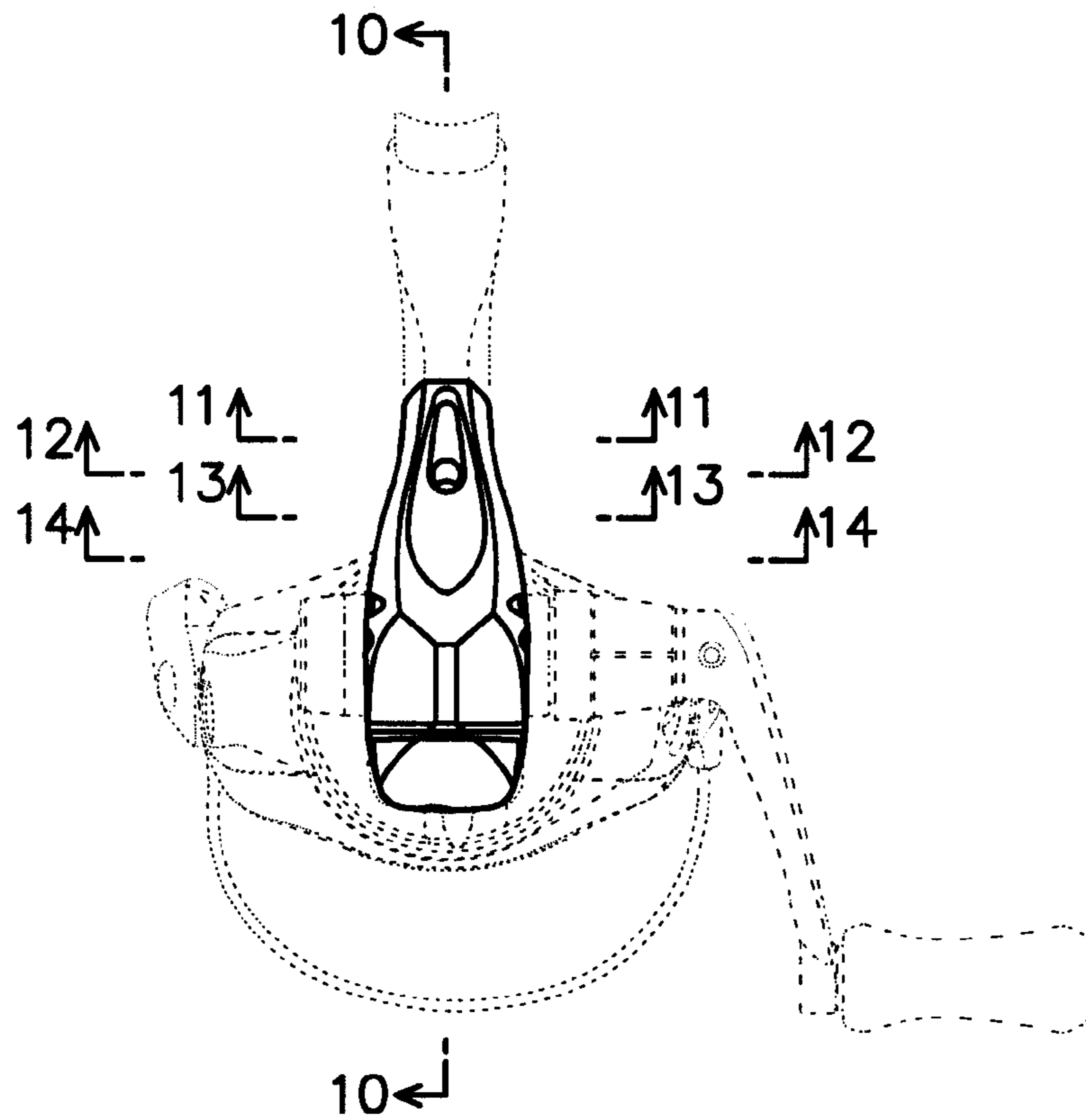

FIGURE 4

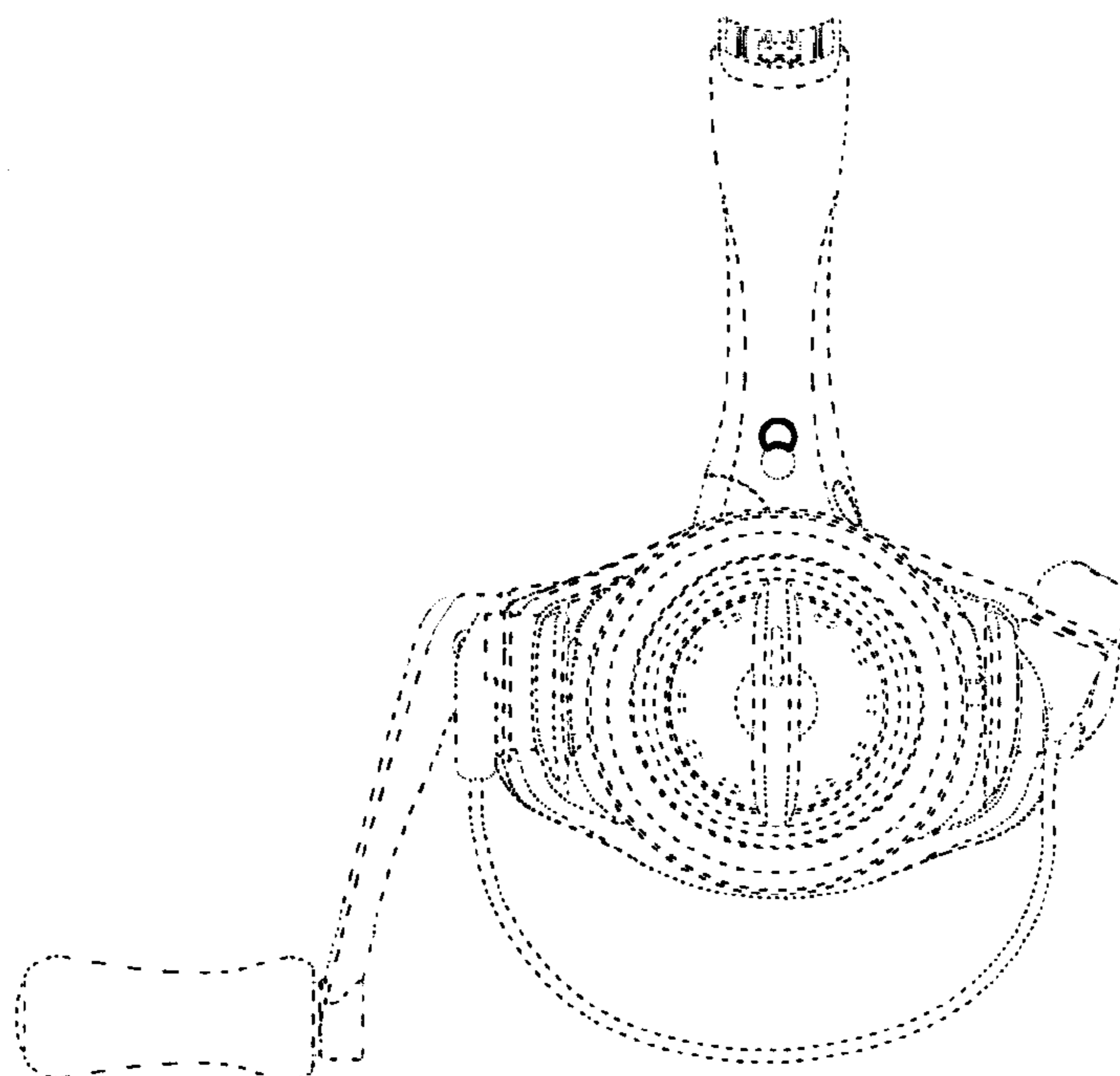

FIGURE 5

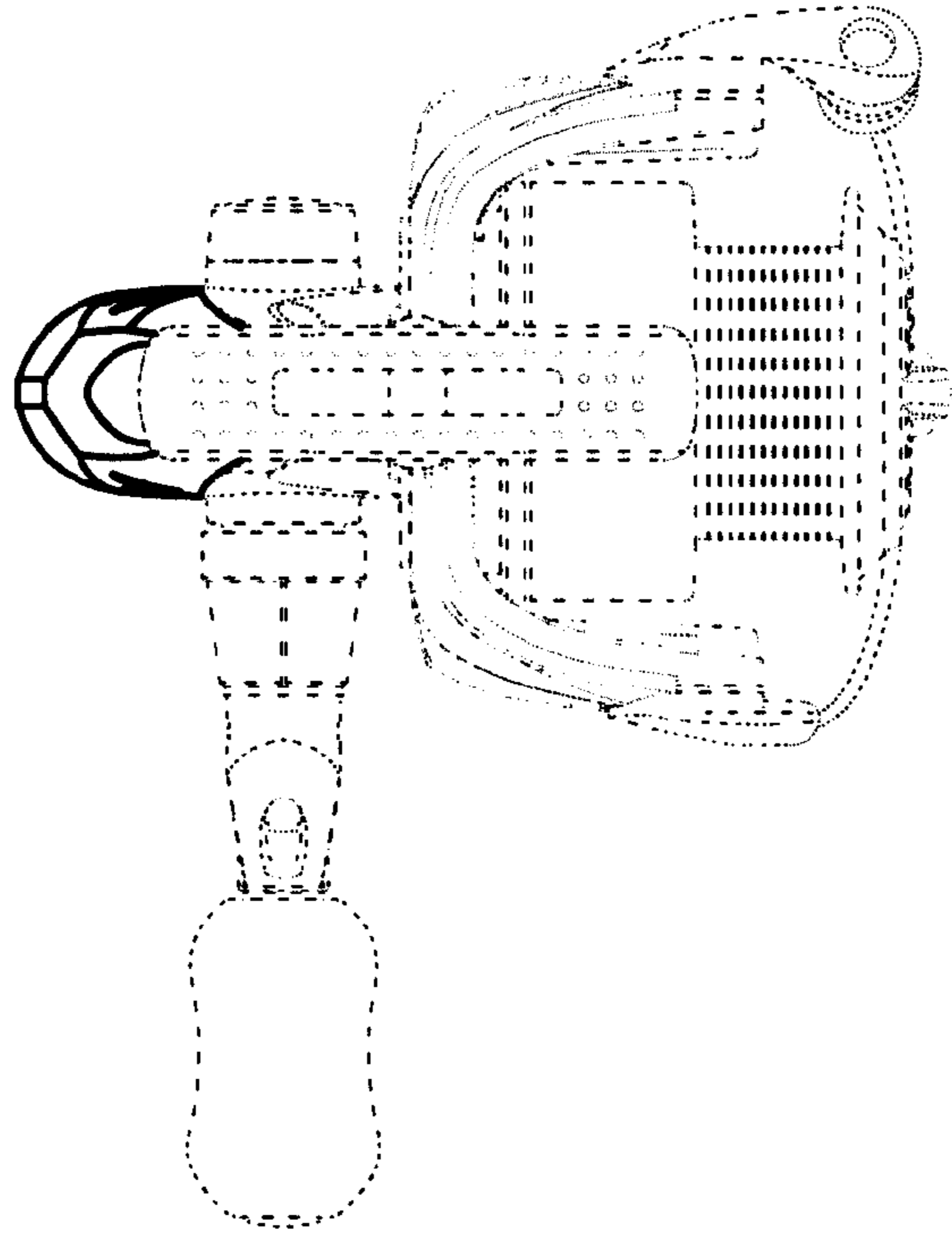

FIGURE 6

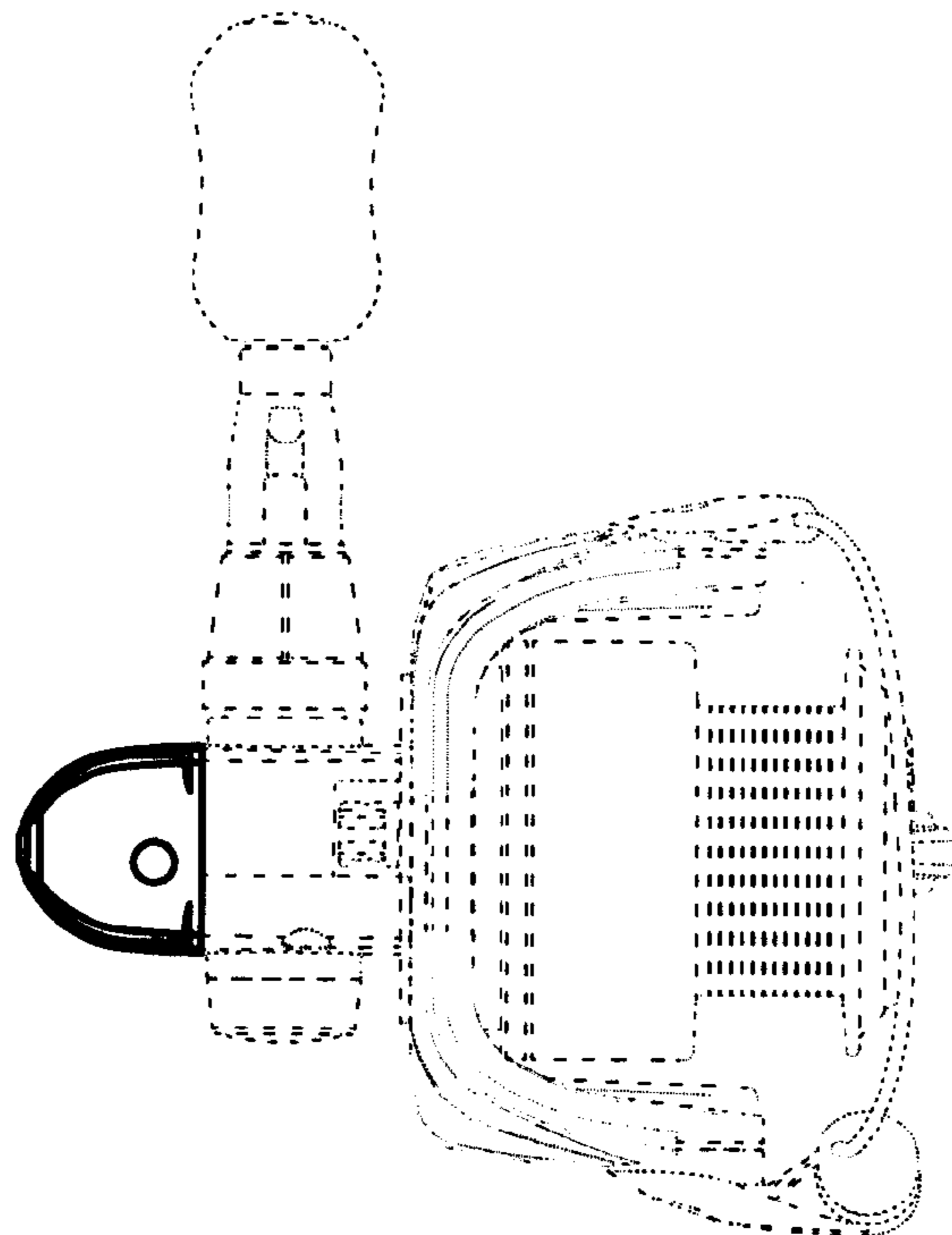

FIGURE 7

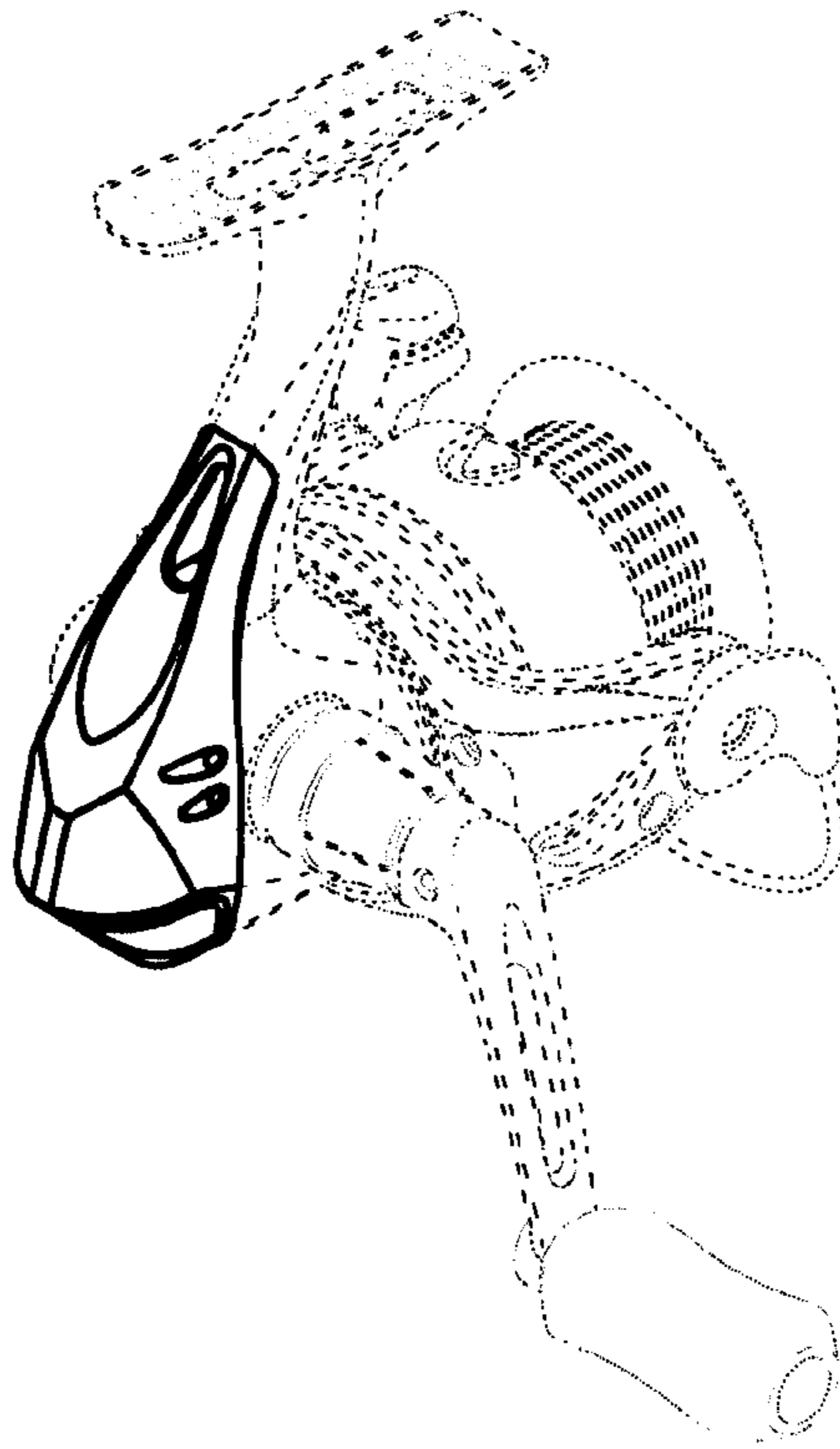

FIGURE 8

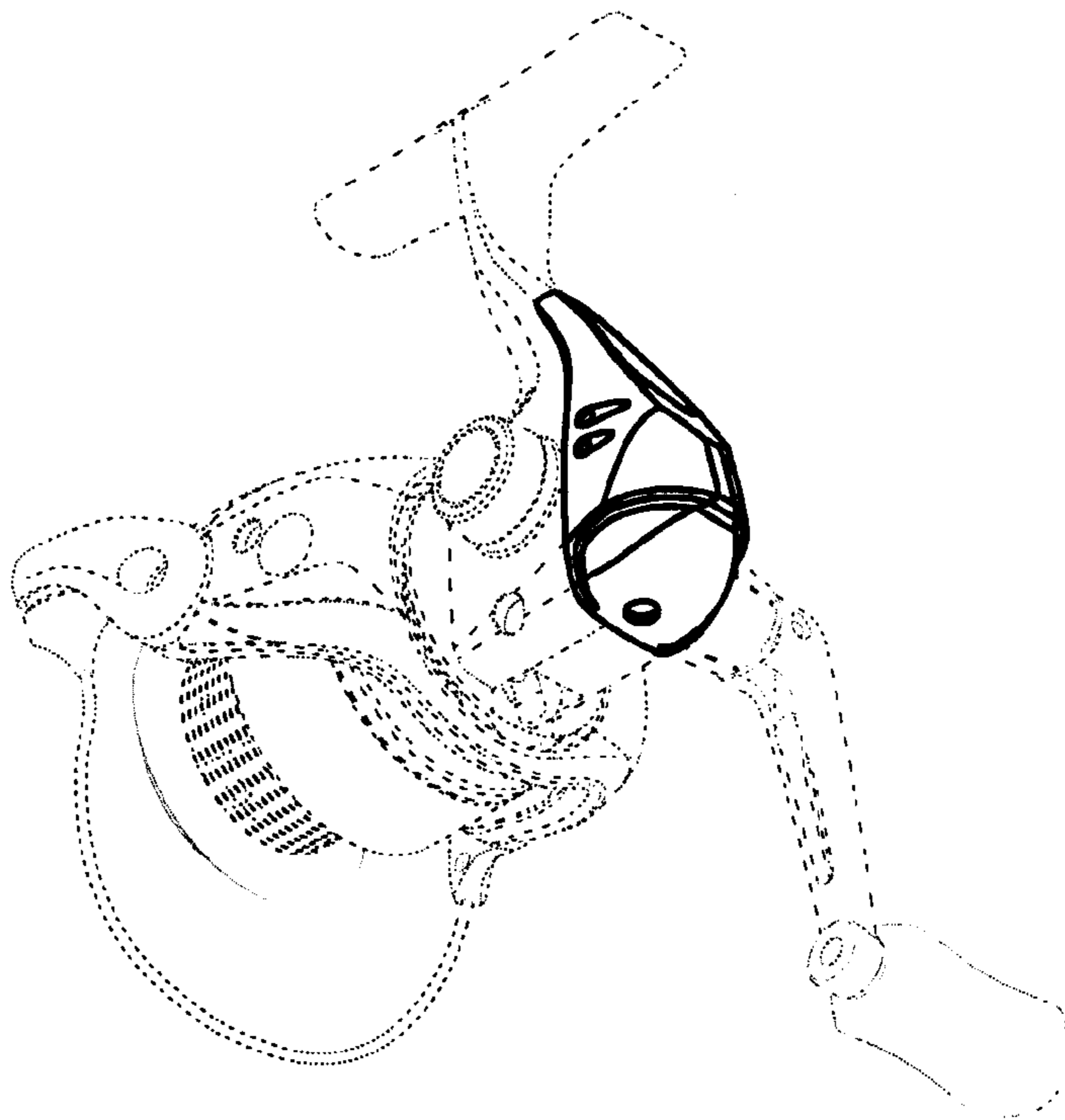

FIGURE 9

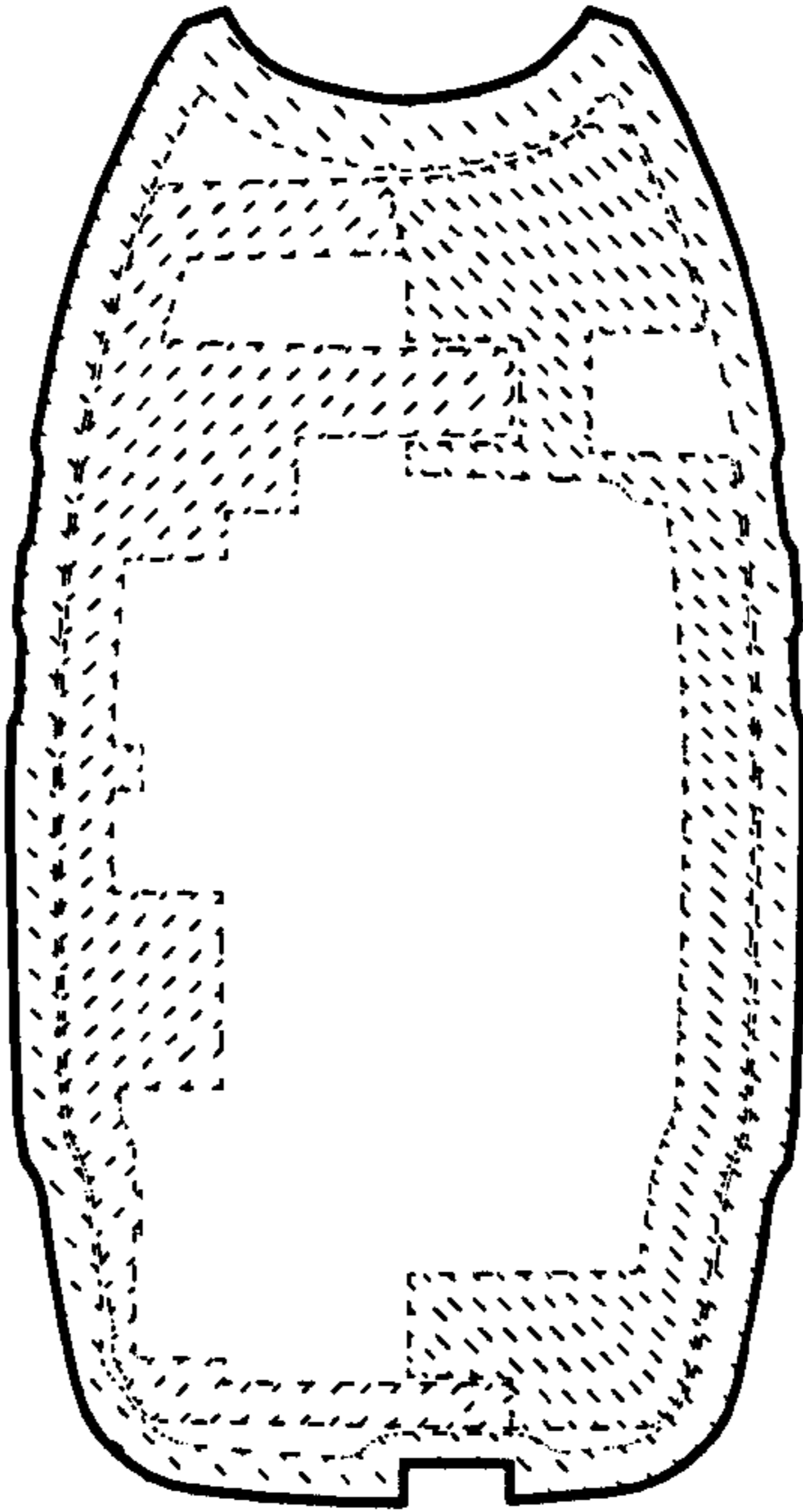

FIGURE 10

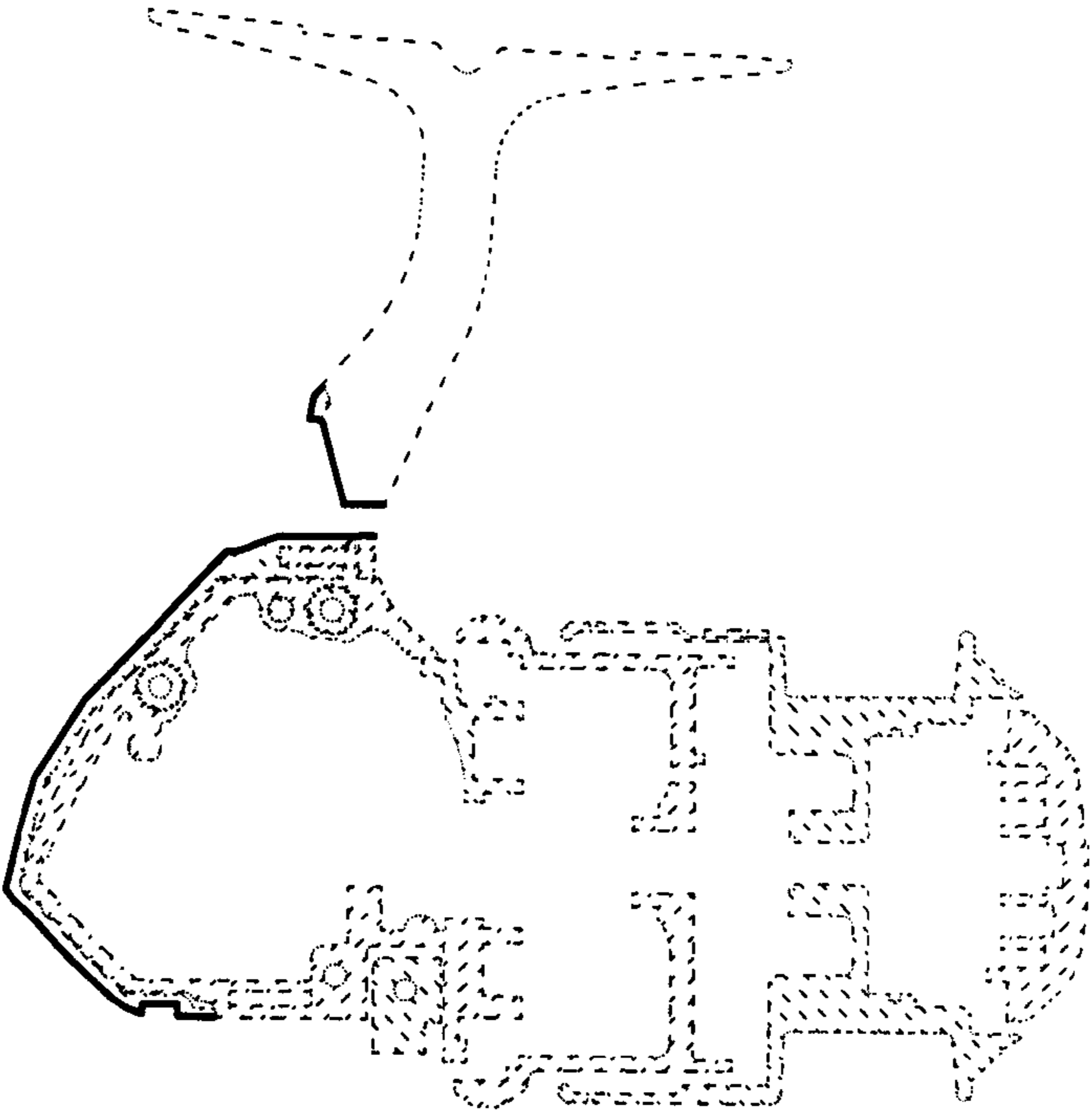

FIGURE 11

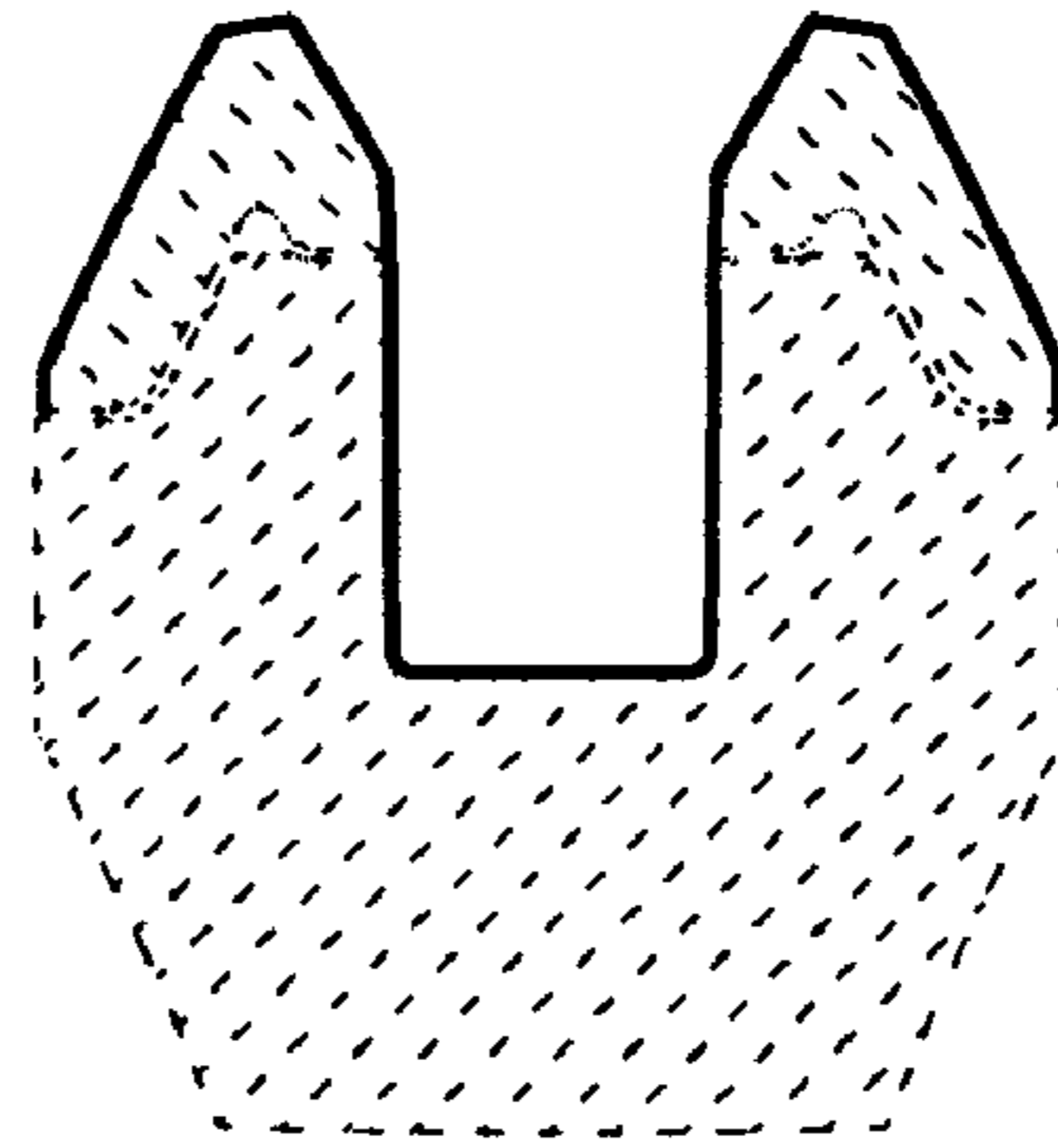

FIGURE 12

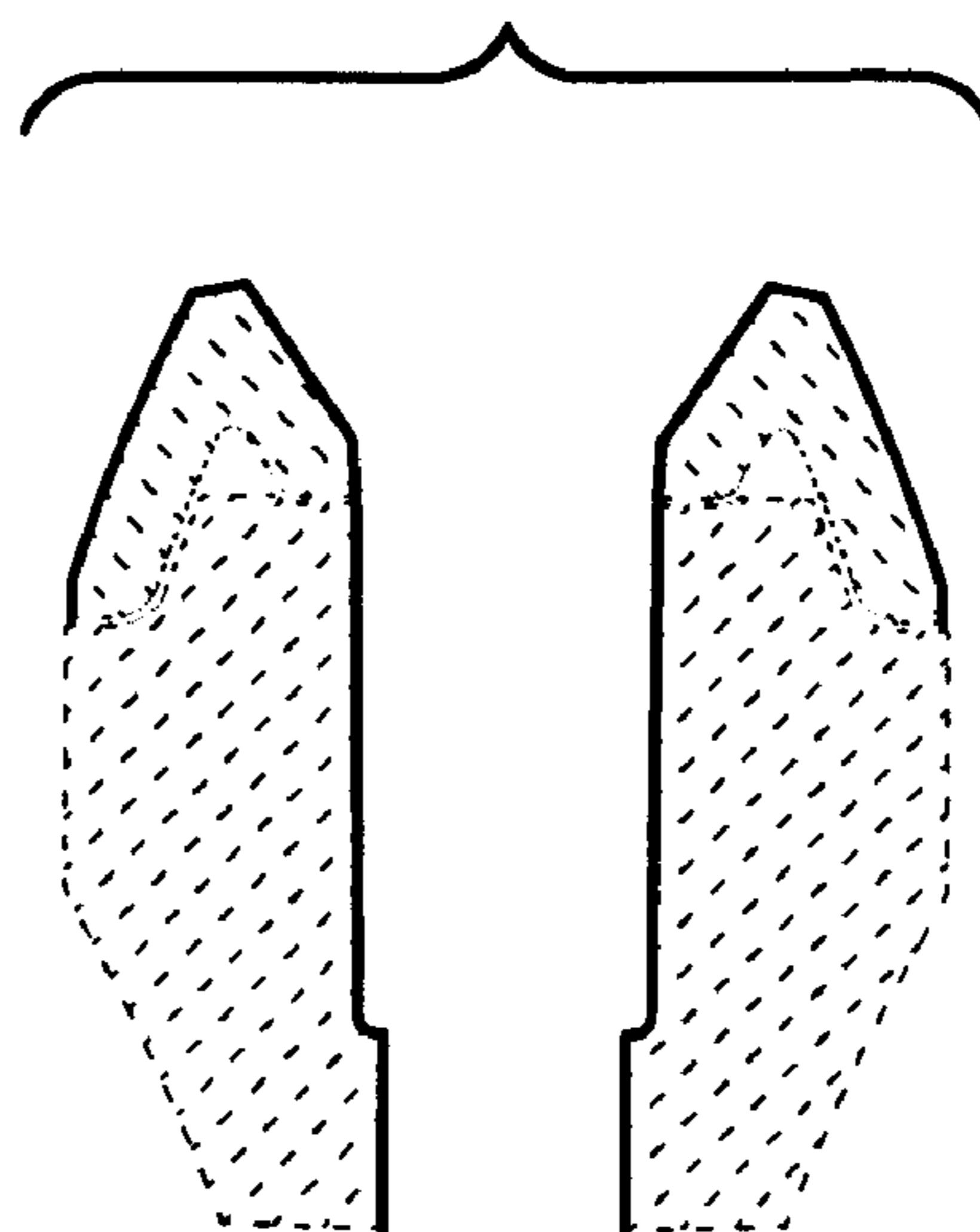

FIGURE 13

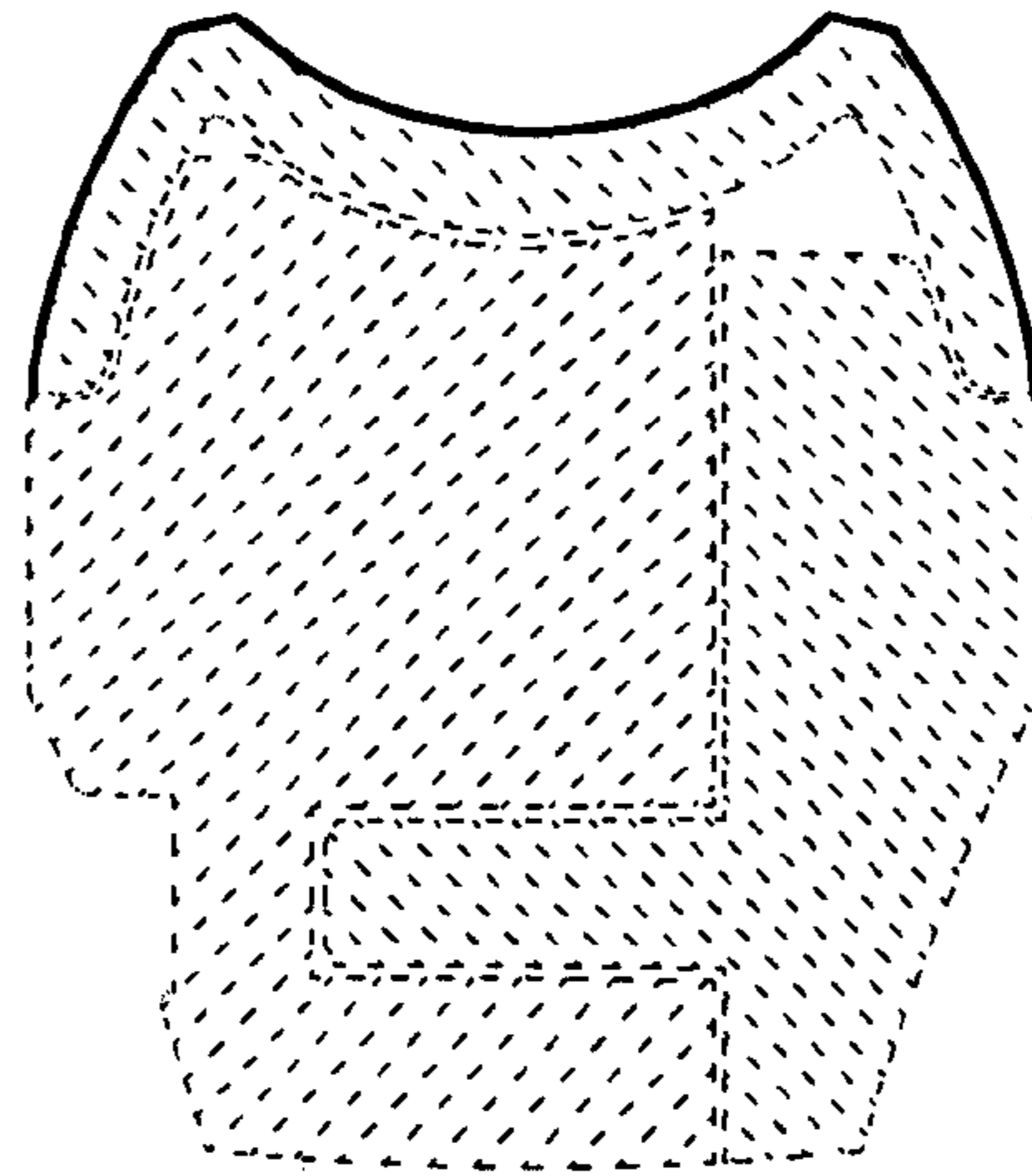

FIGURE 14

