



US00D516529S

(12) **United States Design Patent**
Ko et al.

(10) **Patent No.: US D516,529 S**
(45) **Date of Patent: ** Mar. 7, 2006**

(54) **CAR LCD MONITOR**

(75) Inventors: **Ti-Chieh Ko**, Taipei (TW); **Fu-Long Hong**, Banchiau (TW); **Shu-Chia Wen**, Taipei (TW)

(73) Assignee: **Benq Corporation**, Taoyuan (TW)

(**) Term: **14 Years**

(21) Appl. No.: **29/205,905**

(22) Filed: **May 21, 2004**

(51) **LOC (8) Cl. 14-03**

(52) **U.S. Cl. D14/132**

(58) **Field of Classification Search** D14/125-136,
D14/239, 371, 374-376; 312/7.2; 348/836,
348/838, 180, 184, 325, 739; 341/12; 248/917-924;
345/104, 133, 156, 168, 87, 173; 353/74;
340/700; D12/415-418, 345; D21/329, 515
See application file for complete search history.

(56) **References Cited**

U.S. PATENT DOCUMENTS

5,946,055	A	*	8/1999	Rosen	312/7.2
6,059,255	A	*	5/2000	Rosen et al.	D14/132
D467,234	S	*	12/2002	Scribner	D14/132
D469,068	S	*	1/2003	Furusawa	D14/126
D485,812	S	*	1/2004	Park	D14/132

* cited by examiner

Primary Examiner—Raphael Barkai
(74) *Attorney, Agent, or Firm*—Thomas, Kayden,
Horstemeyer & Risley

(57) **CLAIM**

The ornamental design for a car LCD monitor, as shown and described.

DESCRIPTION

FIG. 1 is a perspective view thereof;
FIG. 2 is a front elevational view thereof;
FIG. 3 is a rear elevational view thereof;
FIG. 4 is a left side elevational view thereof;
FIG. 5 is a right side elevational view thereof;
FIG. 6 is a top plan view thereof;
FIG. 7 is a bottom plan view thereof;
FIG. 8 is a perspective view thereof in a close status;
FIG. 9 is a front elevational view thereof in a close status;
FIG. 10 is a rear elevational view thereof in a close status;
FIG. 11 is a left side elevational view thereof in a close status;
FIG. 12 is a right side elevational view thereof in a close status;
FIG. 13 is a top plan view thereof in a close status; and,
FIG. 14 is a bottom plan view thereof in a close status.

1 Claim, 14 Drawing Sheets

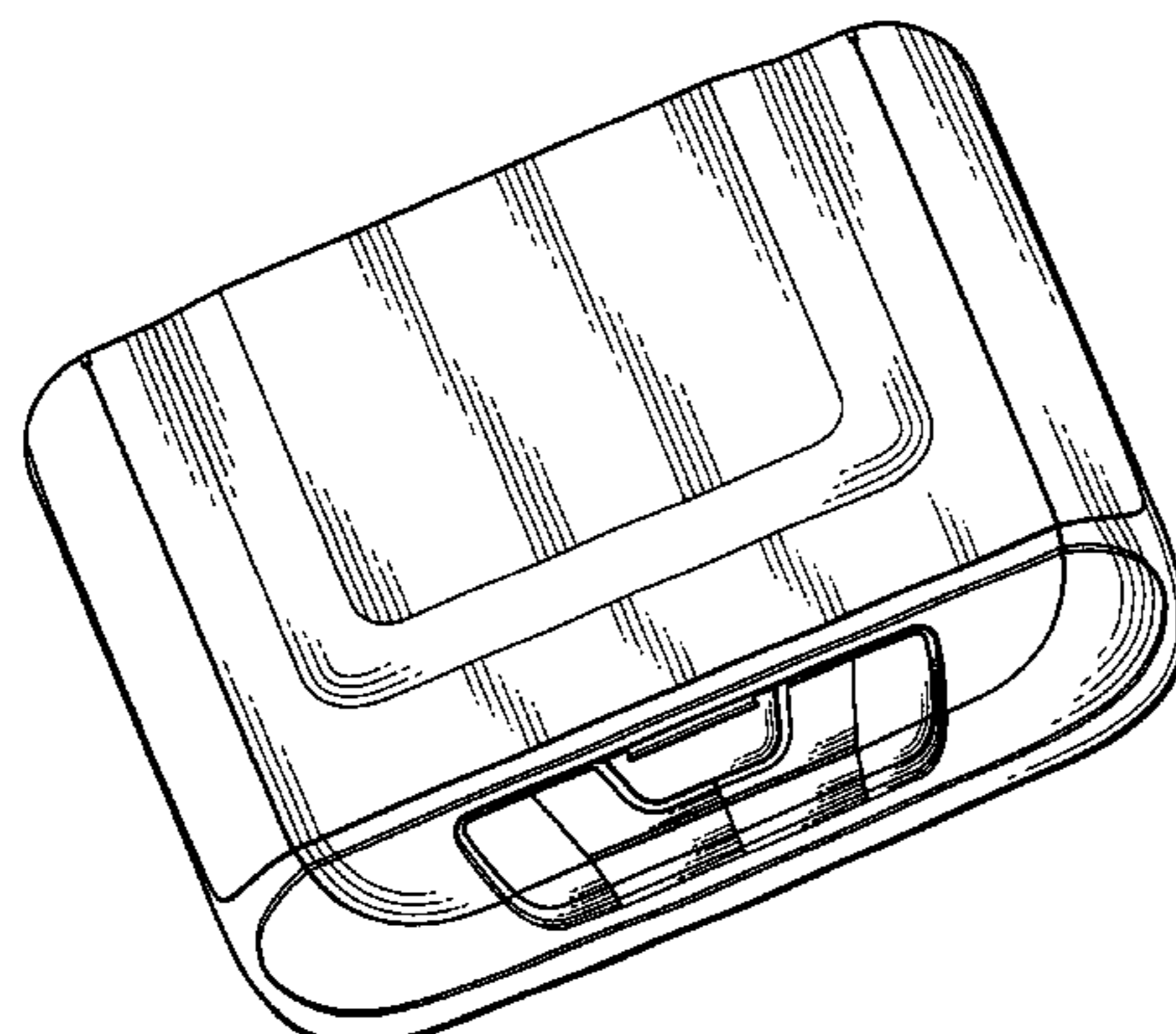
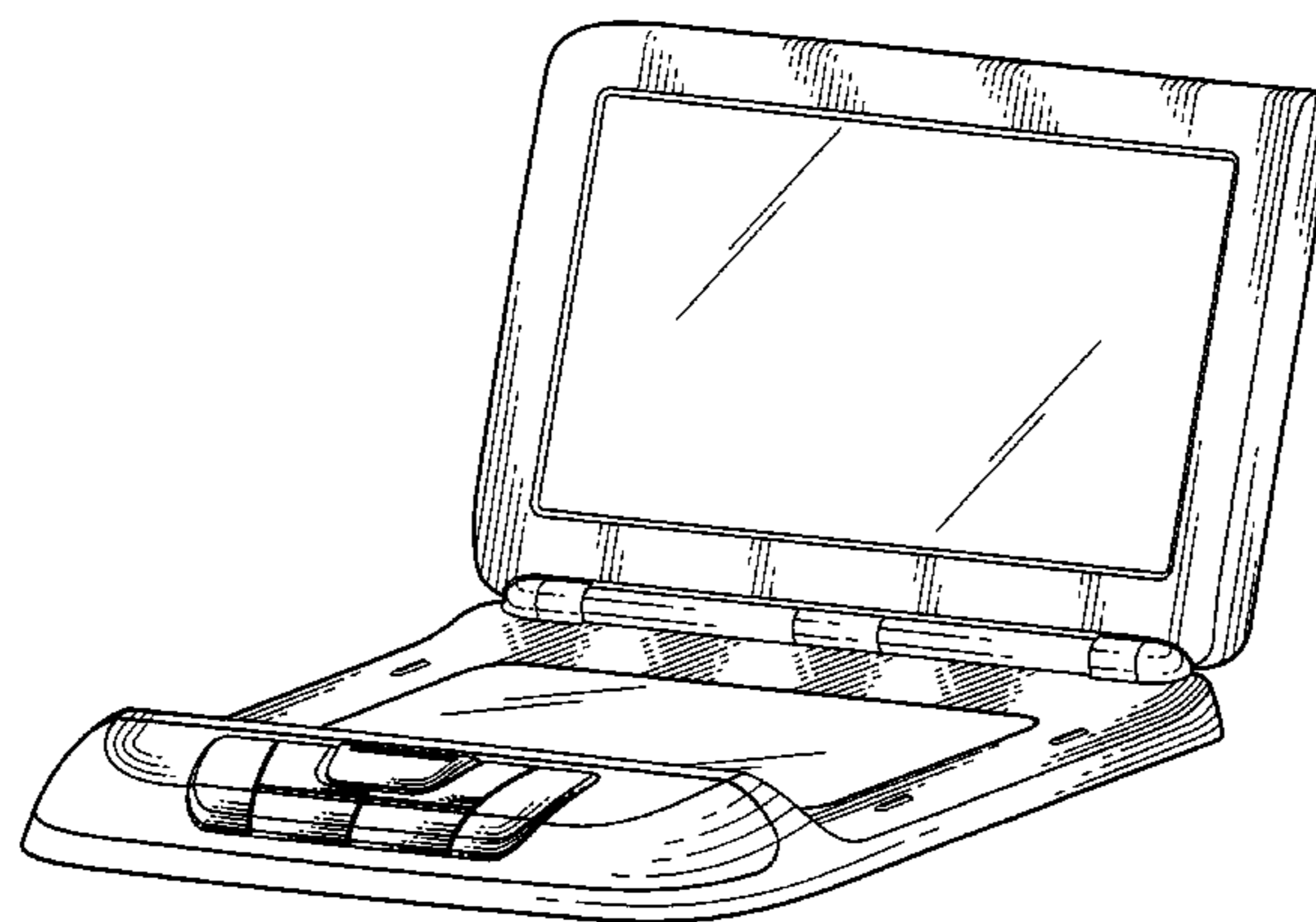

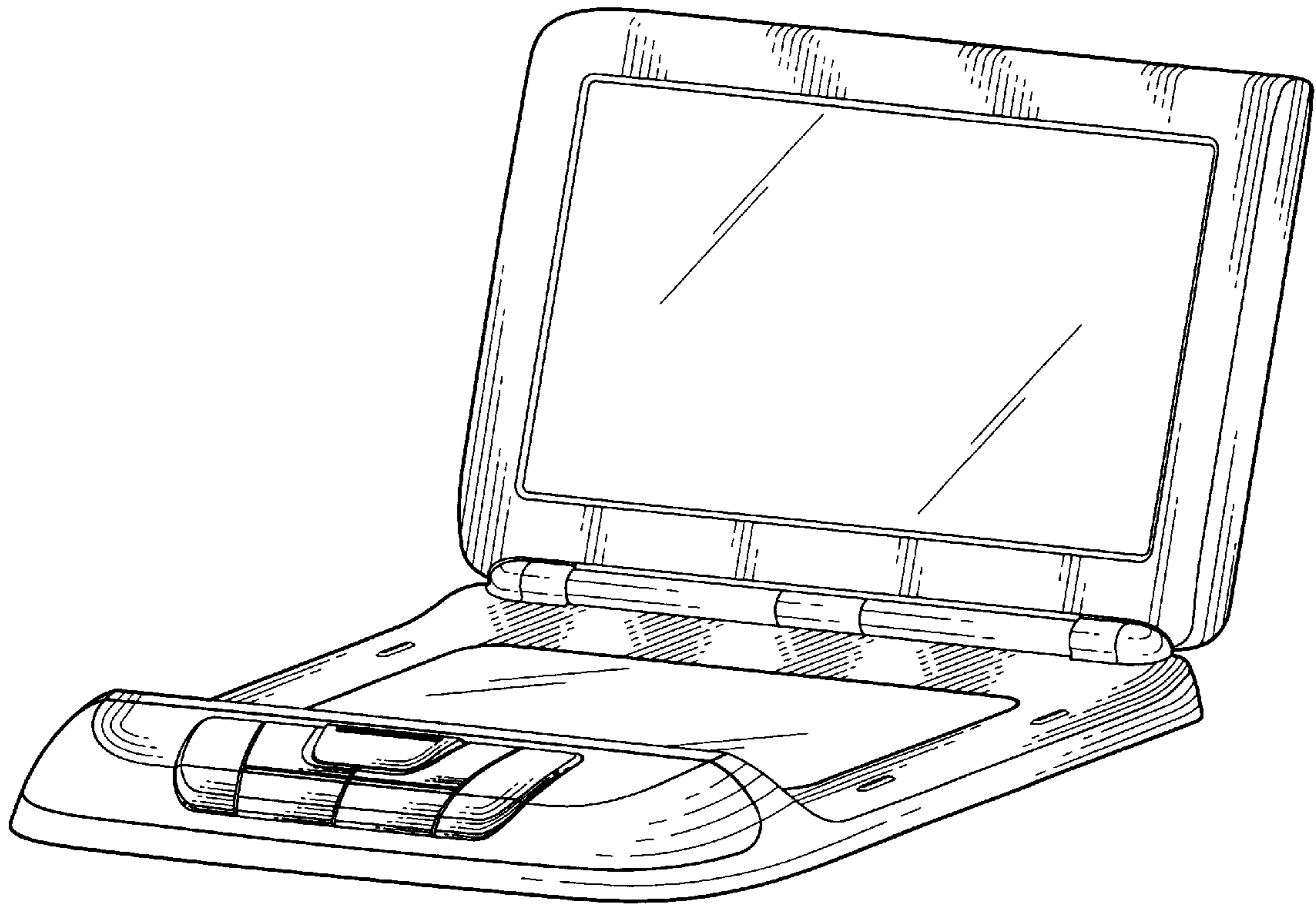

FIG. 1

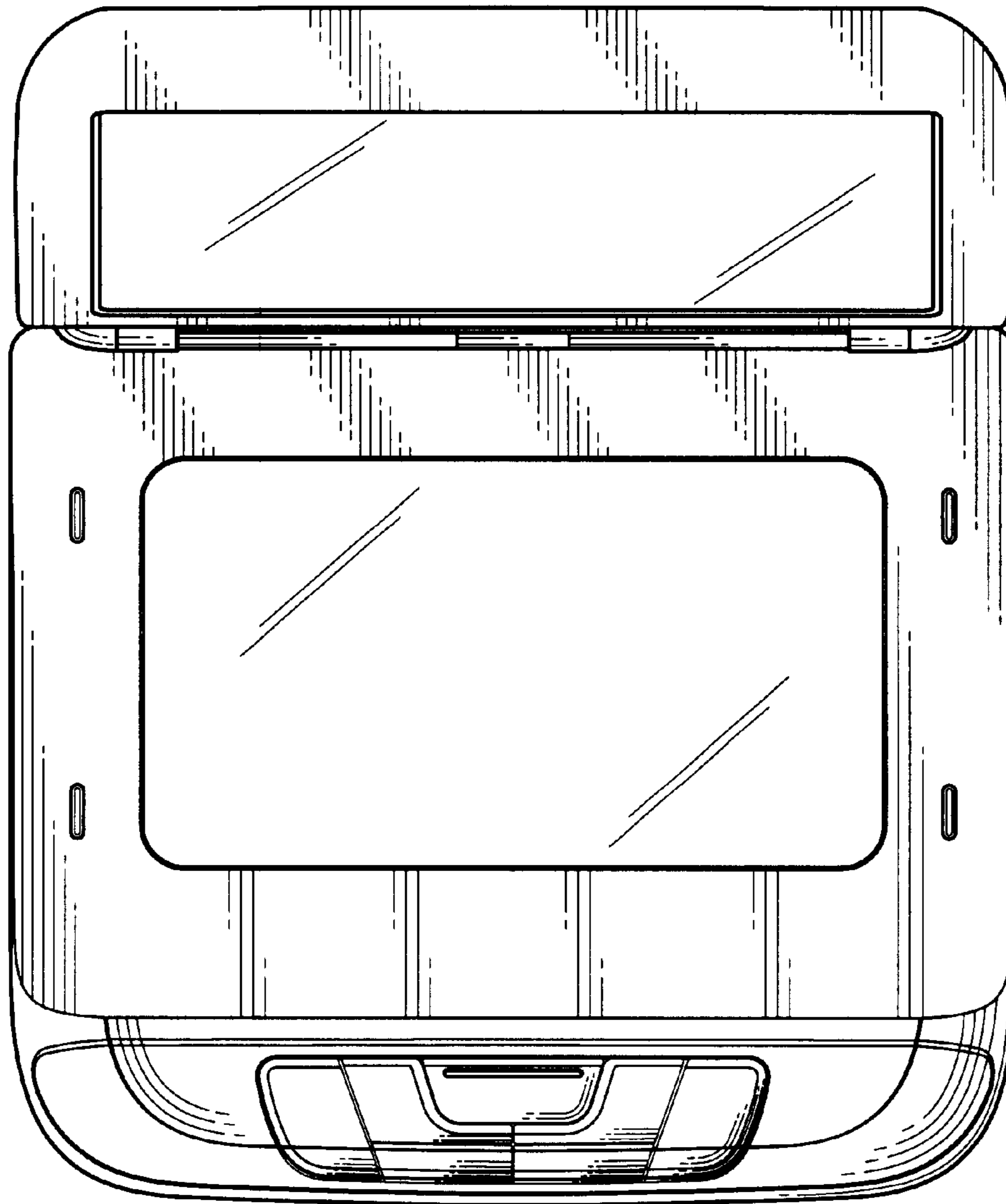

FIG. 2

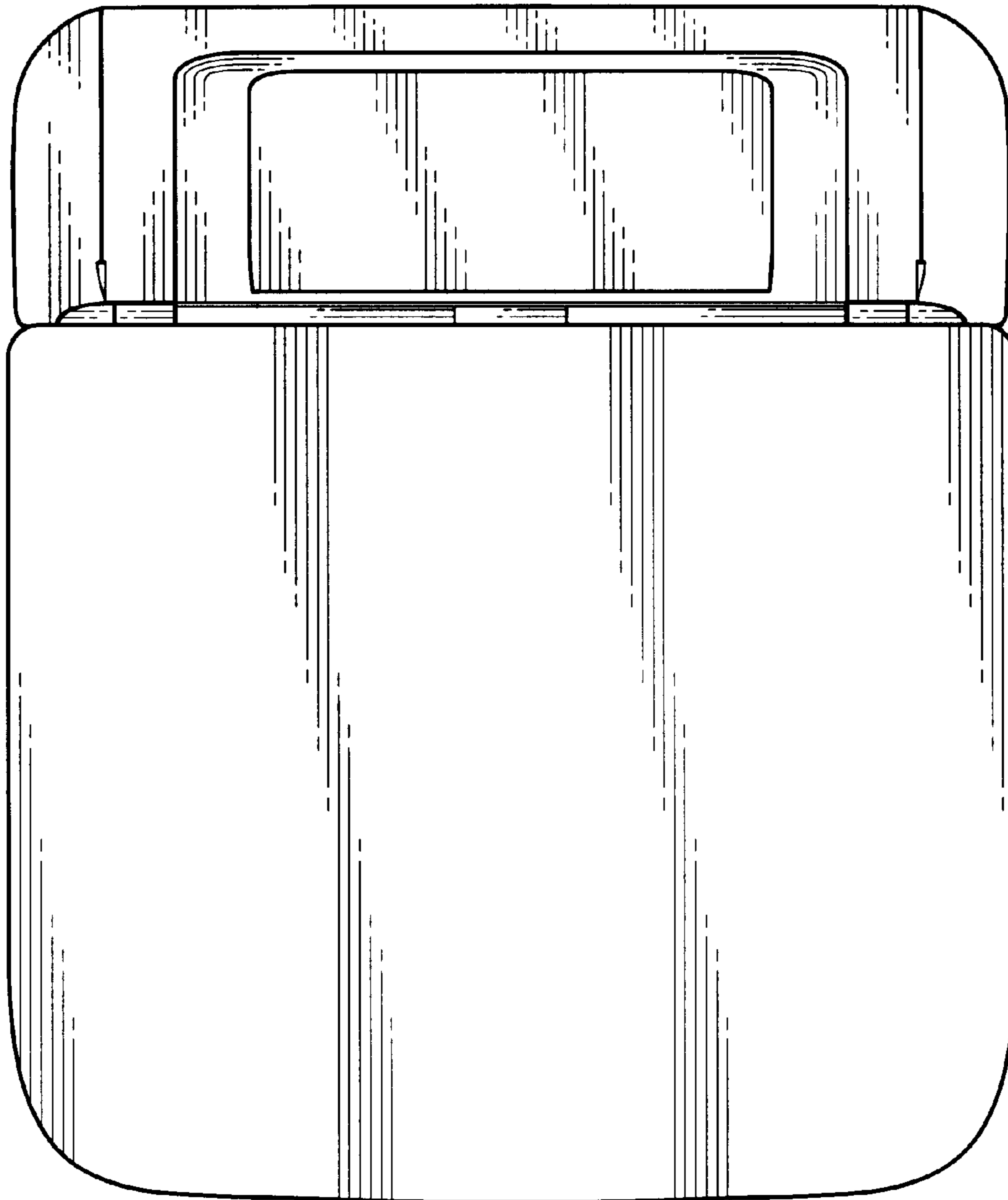

FIG. 3

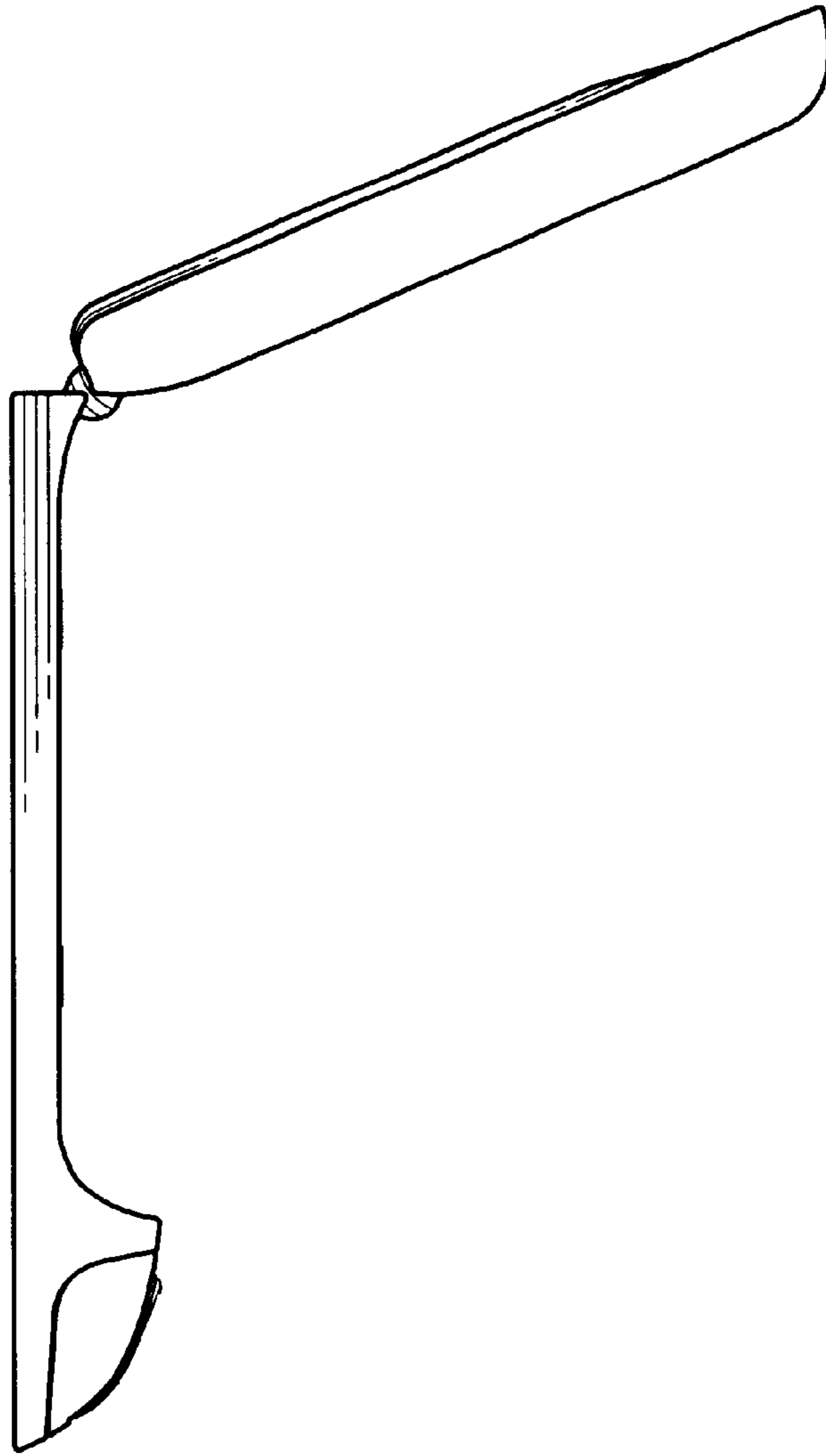

FIG. 4

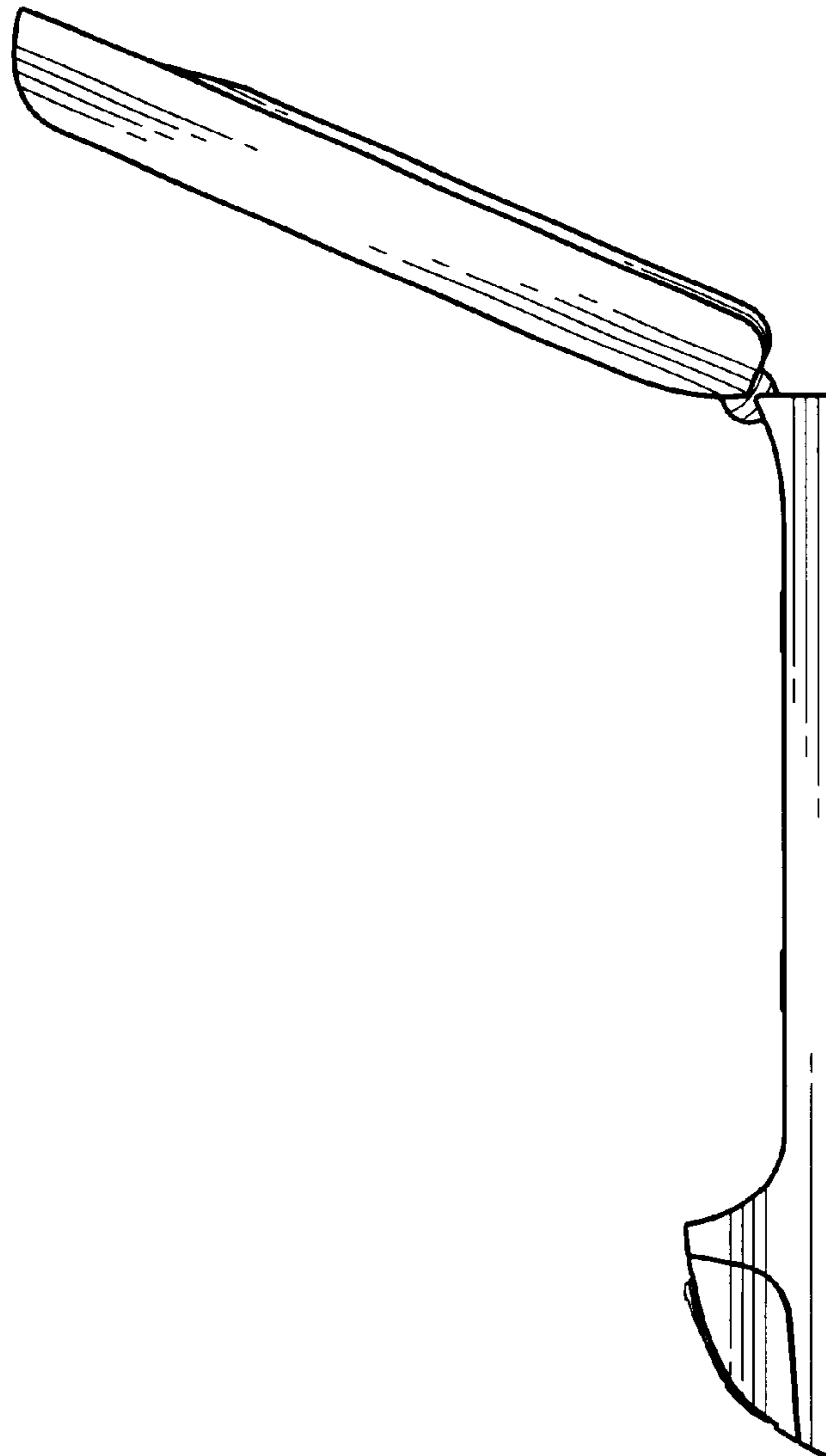

FIG. 5

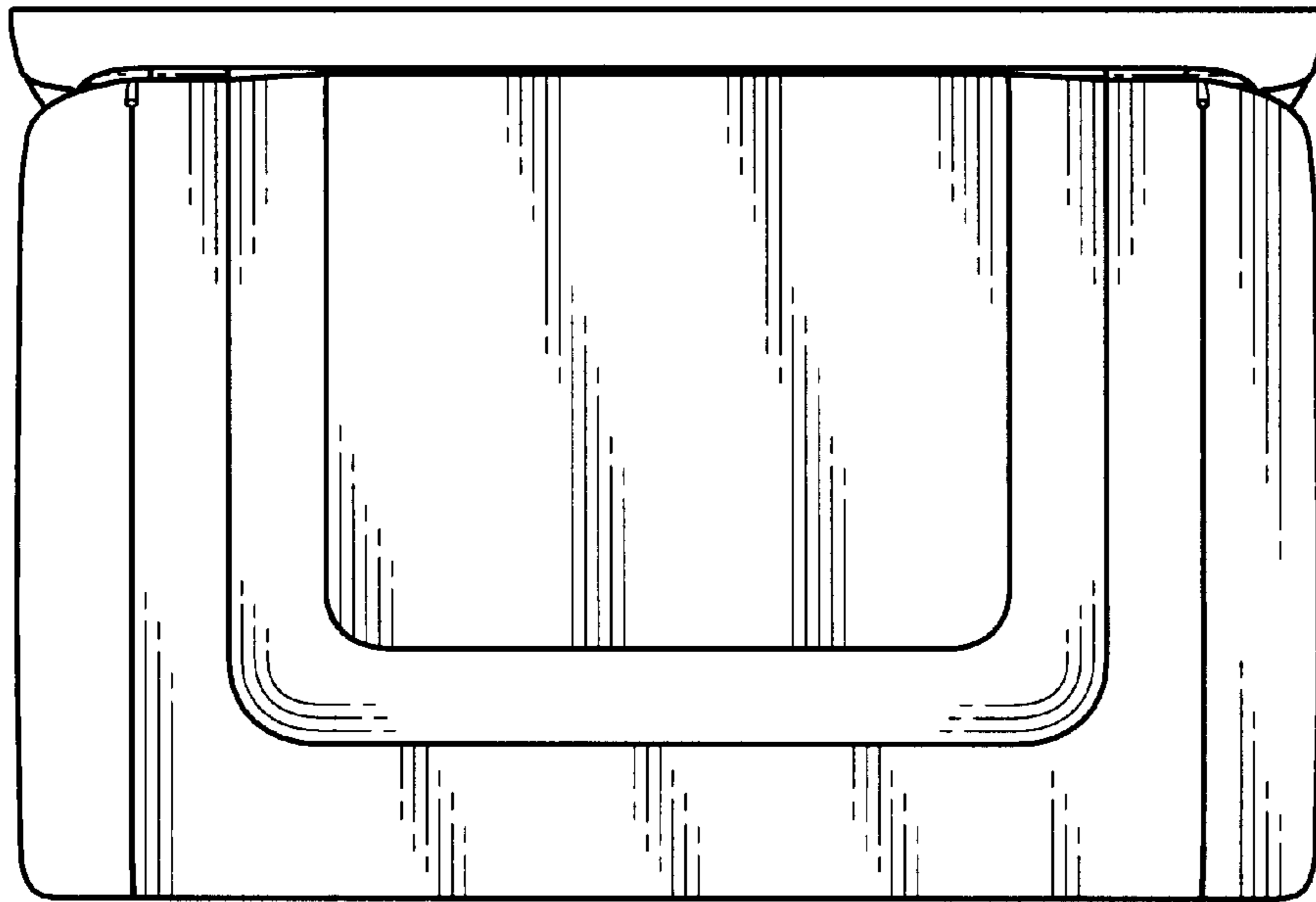

FIG. 6

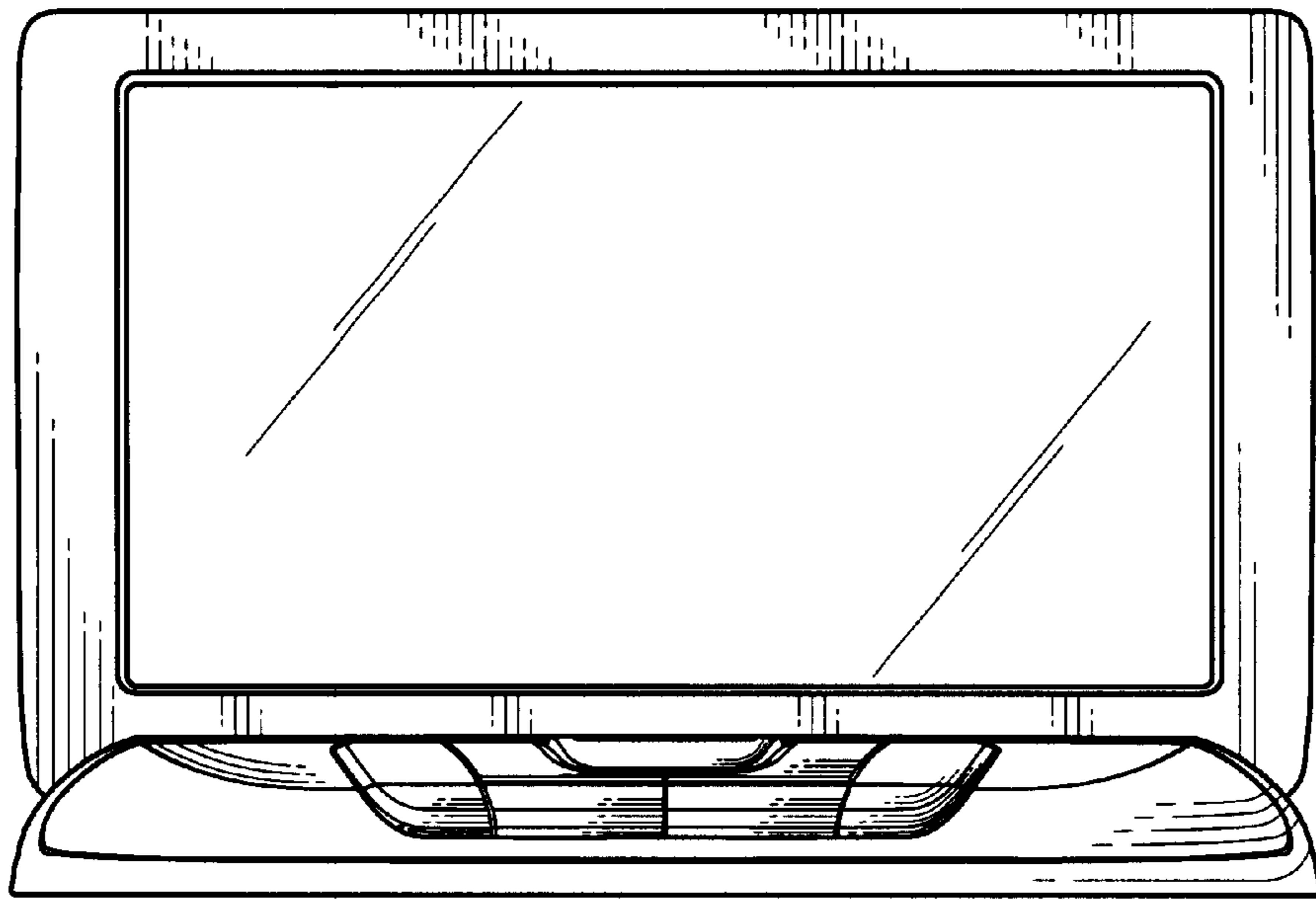

FIG. 7

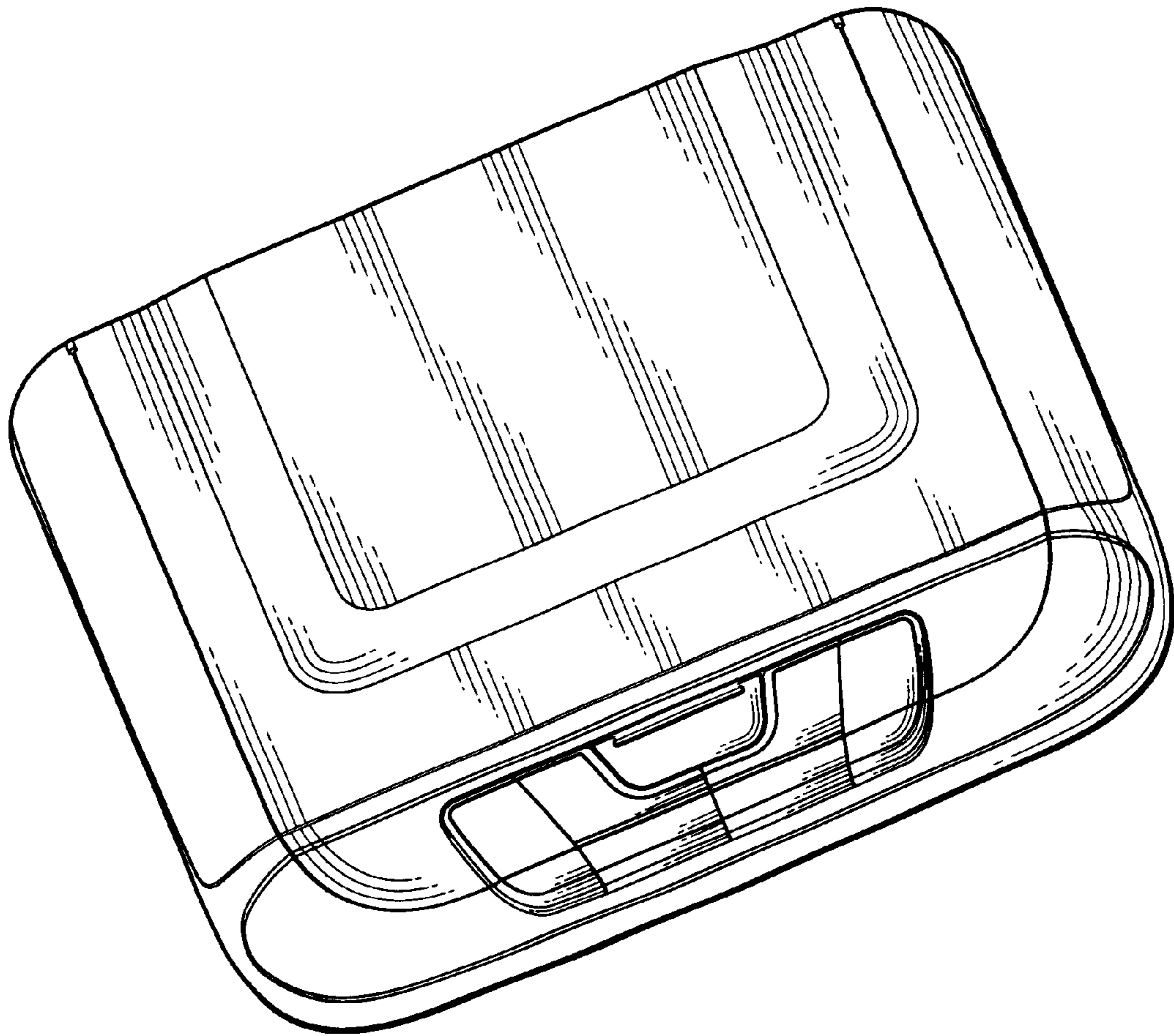

FIG. 8

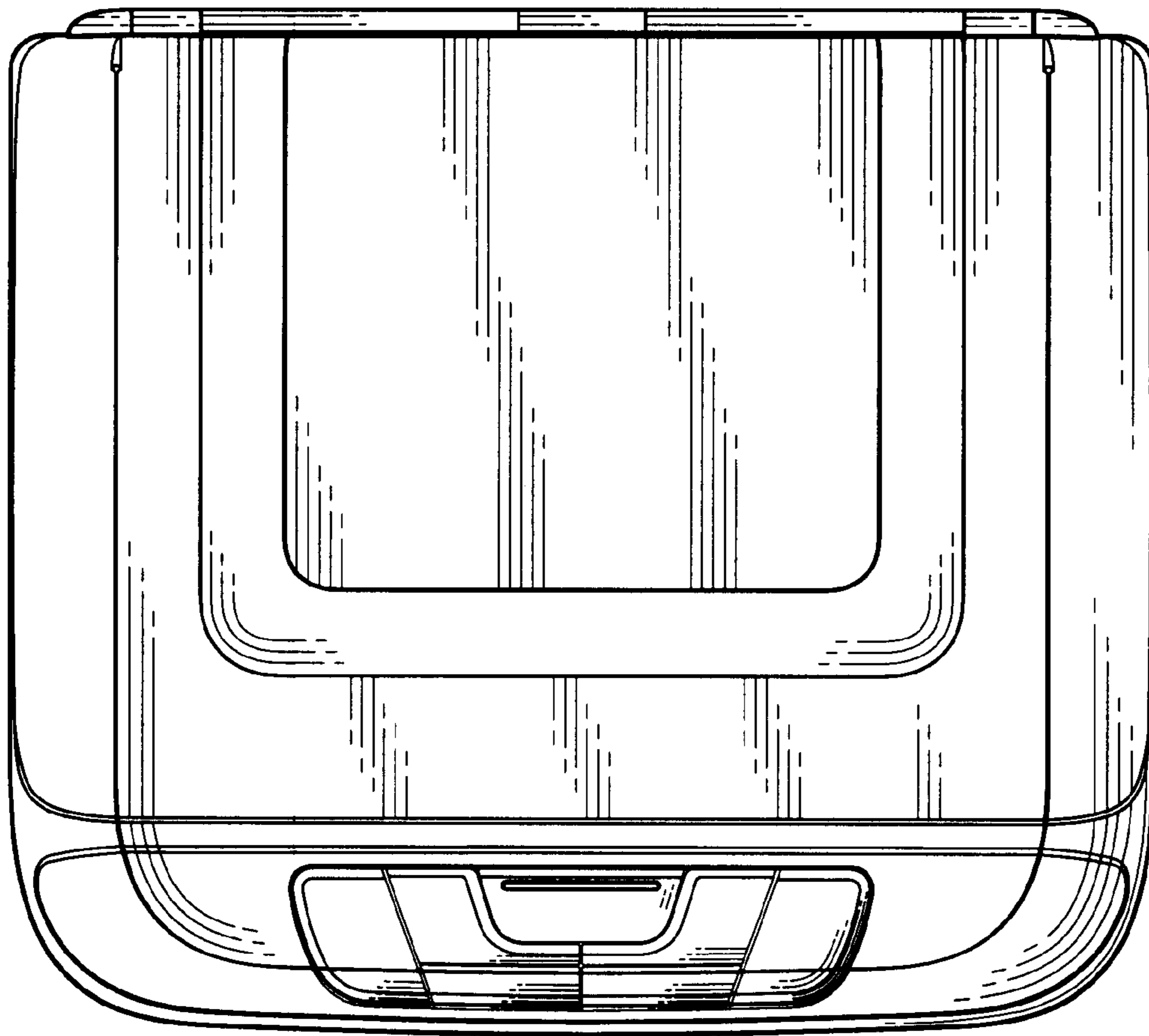

FIG. 9

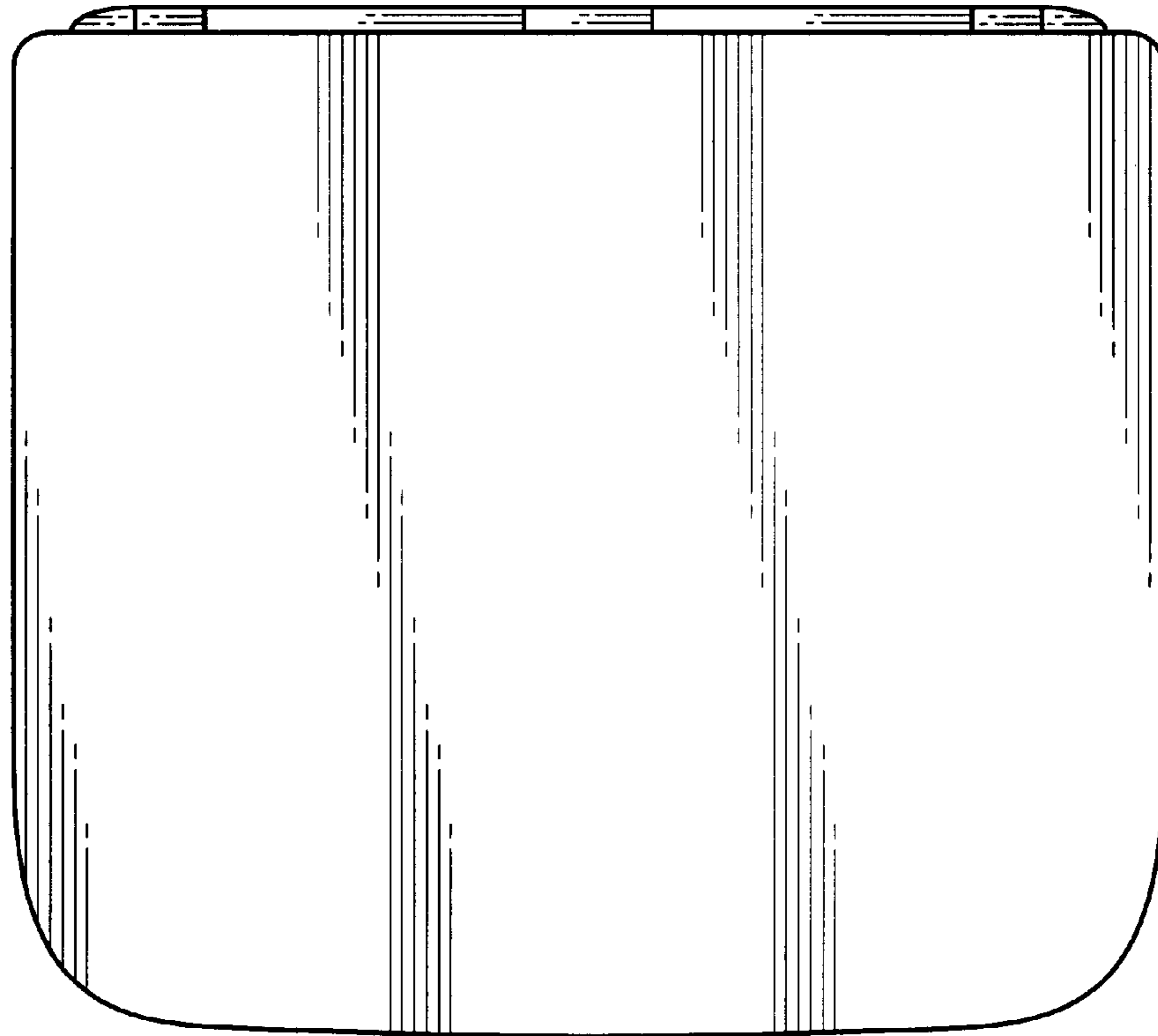

FIG. 10

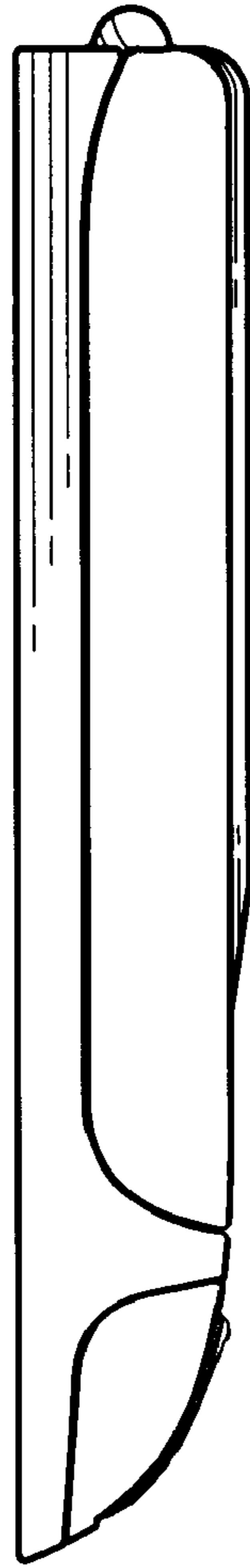

FIG. 11

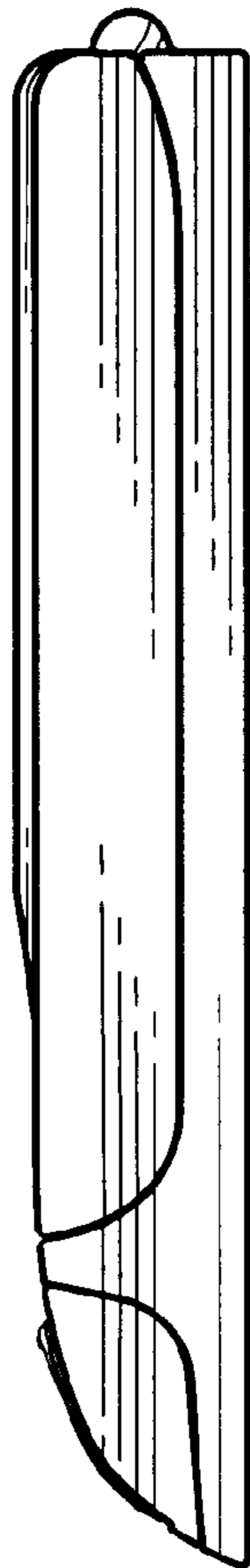

FIG. 12



FIG. 13

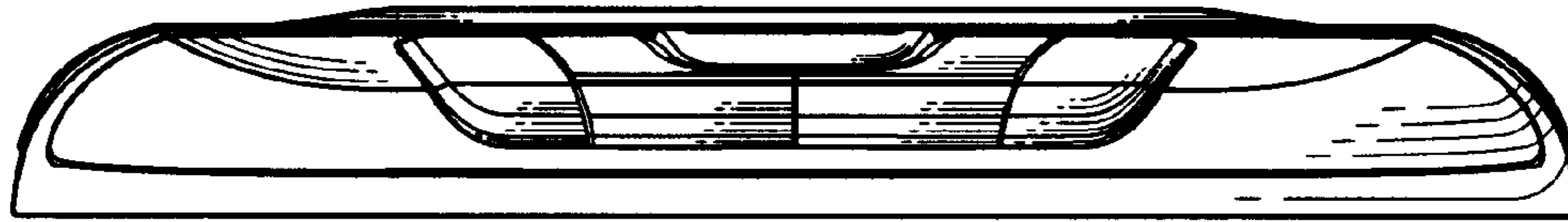

FIG. 14