



US00D516473S

(12) **United States Design Patent**
Kawasaki

(10) **Patent No.:** **US D516,473 S**
(45) **Date of Patent:** **** Mar. 7, 2006**

(54) **BUMPER FOR AN AUTOMOBILE**

(75) Inventor: **Masakazu Kawasaki**, Aichi-ken (JP)
(73) Assignee: **Toyota Jidosha Kabushiki Kaisha** (JP)
(**) Term: **14 Years**

(21) Appl. No.: **29/219,060**
(22) Filed: **Dec. 10, 2004**

(51) **LOC (8) Cl.** **12-16**
(52) **U.S. Cl.** **D12/169**
(58) **Field of Classification Search** **D12/90-92,**
D12/86, 169, 196, 163; 296/180.1, 180.2;
293/102, 113, 115, 117, 120

See application file for complete search history.

(56) **References Cited**

U.S. PATENT DOCUMENTS

| | | | | | |
|------------|---|---------|------------------|-------|---------|
| D463,334 S | * | 9/2002 | Koman | | D12/169 |
| D472,856 S | * | 4/2003 | Oishi et al. | | D12/169 |
| D473,499 S | * | 4/2003 | Tanabe et al. | | D12/169 |
| D474,720 S | * | 5/2003 | Tachibana et al. | | D12/169 |
| D492,627 S | * | 7/2004 | Metros et al. | | D12/169 |
| D500,270 S | * | 12/2004 | Otto et al. | | D12/169 |
| D504,851 S | * | 5/2005 | Hosoda et al. | | D12/169 |

OTHER PUBLICATIONS

Nissan, TEANA 2003, Automotive Guide Book of Japan, Oct. 22, 2003, p. 136.
Nissan, PRIMERA 2003, Automotive Guide Book of Japan, Oct. 22, 2003, p. 136.

* cited by examiner

Primary Examiner—Melody N. Brown
(74) *Attorney, Agent, or Firm*—Saidman DesignLaw Group

(57) **CLAIM**

The ornamental design for a bumper for an automobile, as shown and described.

DESCRIPTION

FIG. 1 is a perspective view of a bumper for an automobile showing our new design;
FIG. 2 is a front view thereof;
FIG. 3 is a rear view thereof;
FIG. 4 is a top view thereof;
FIG. 5 is a bottom view; and,
FIG. 6 is a right-side view thereof, the left-side view being a mirror image.

1 Claim, 5 Drawing Sheets

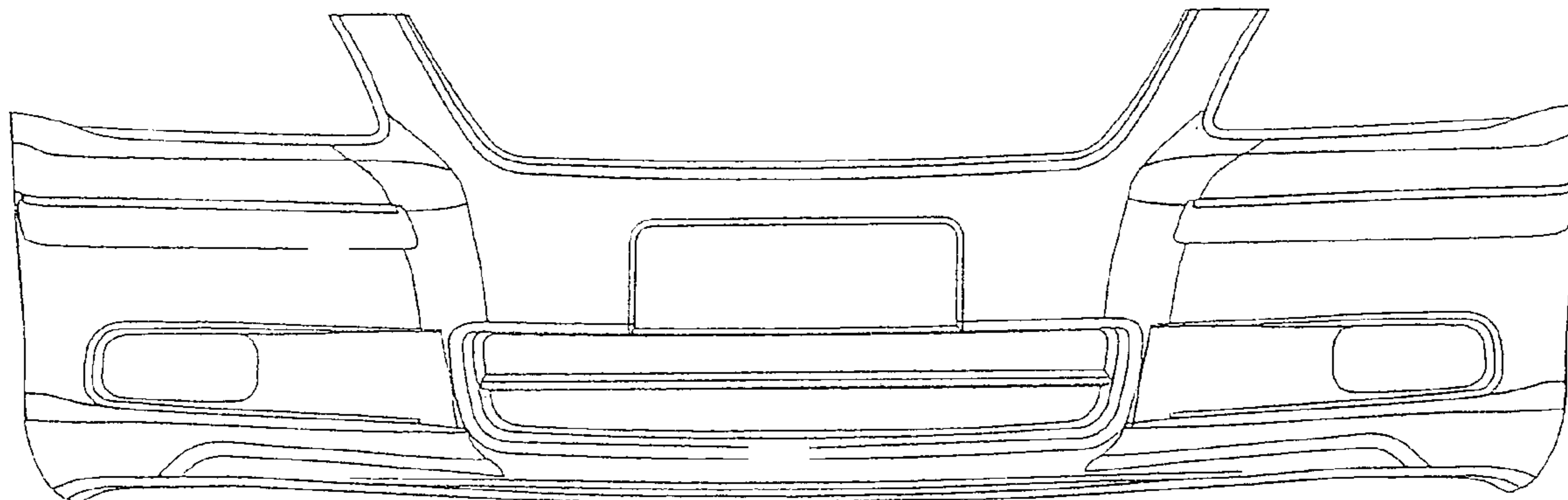

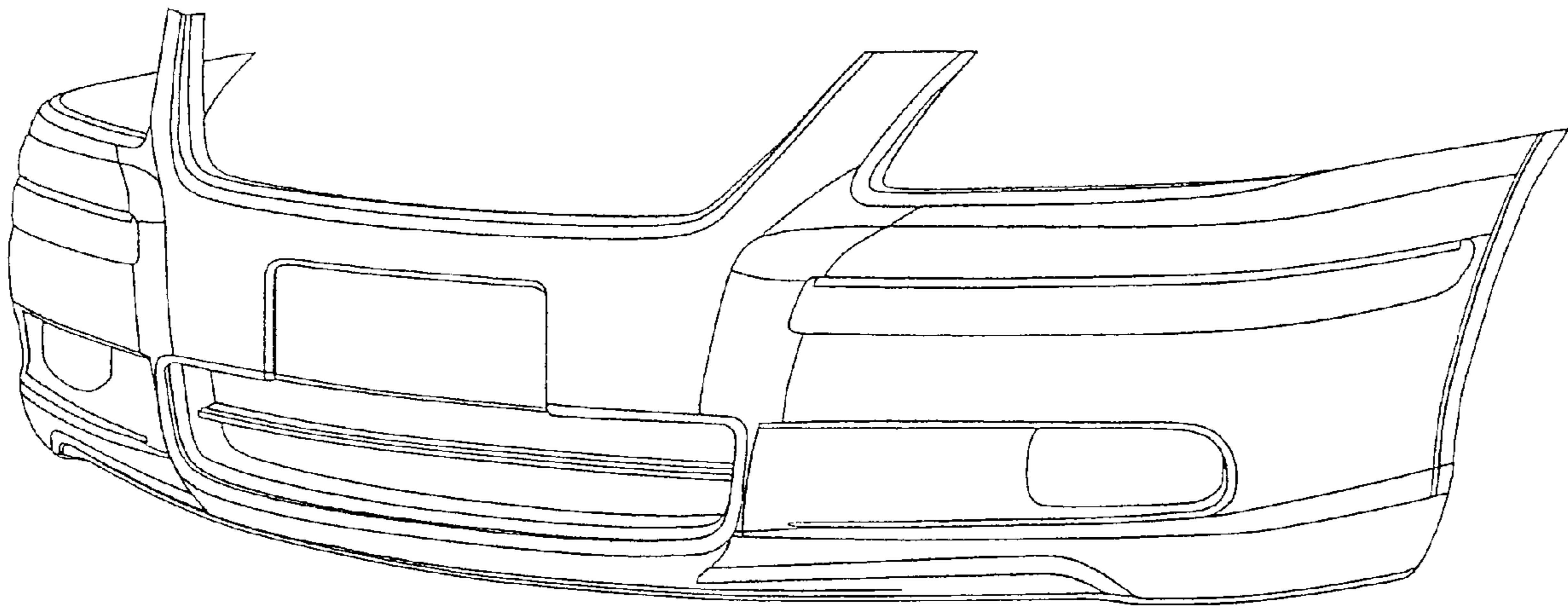

FIG. 1

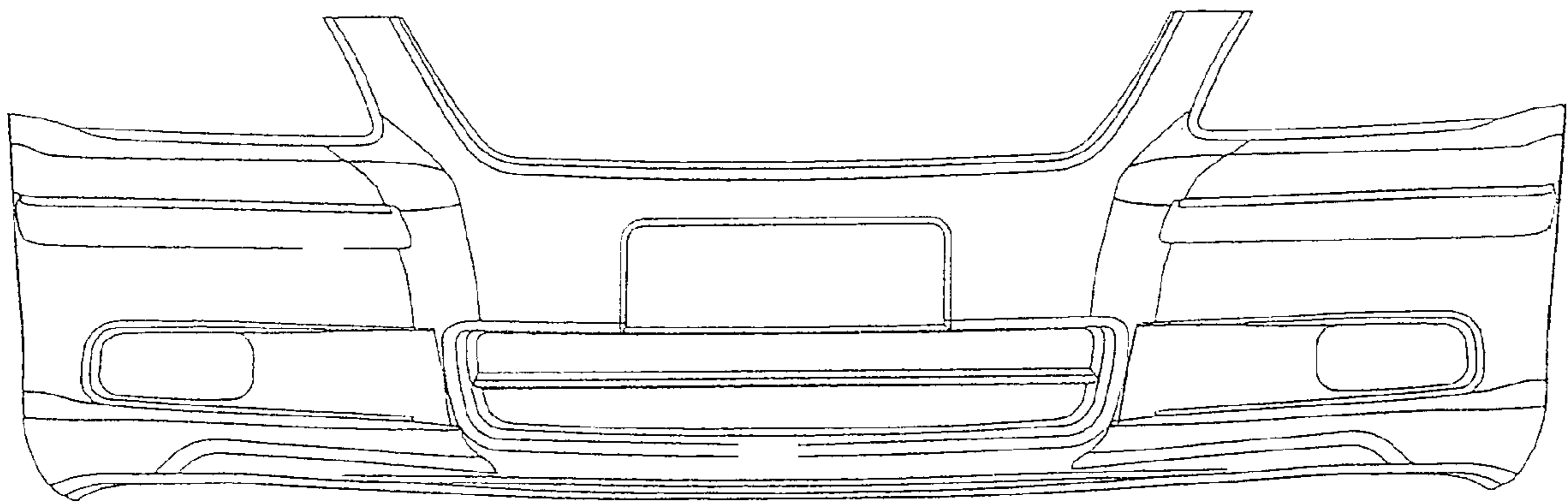

FIG. 2

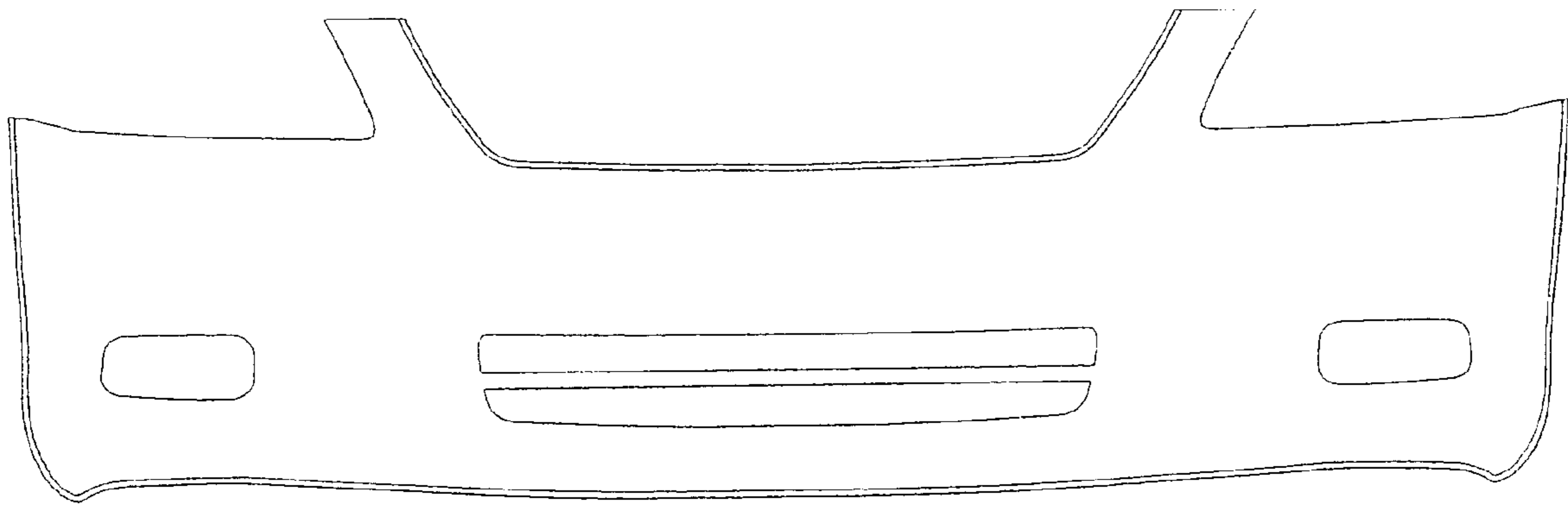

FIG. 3

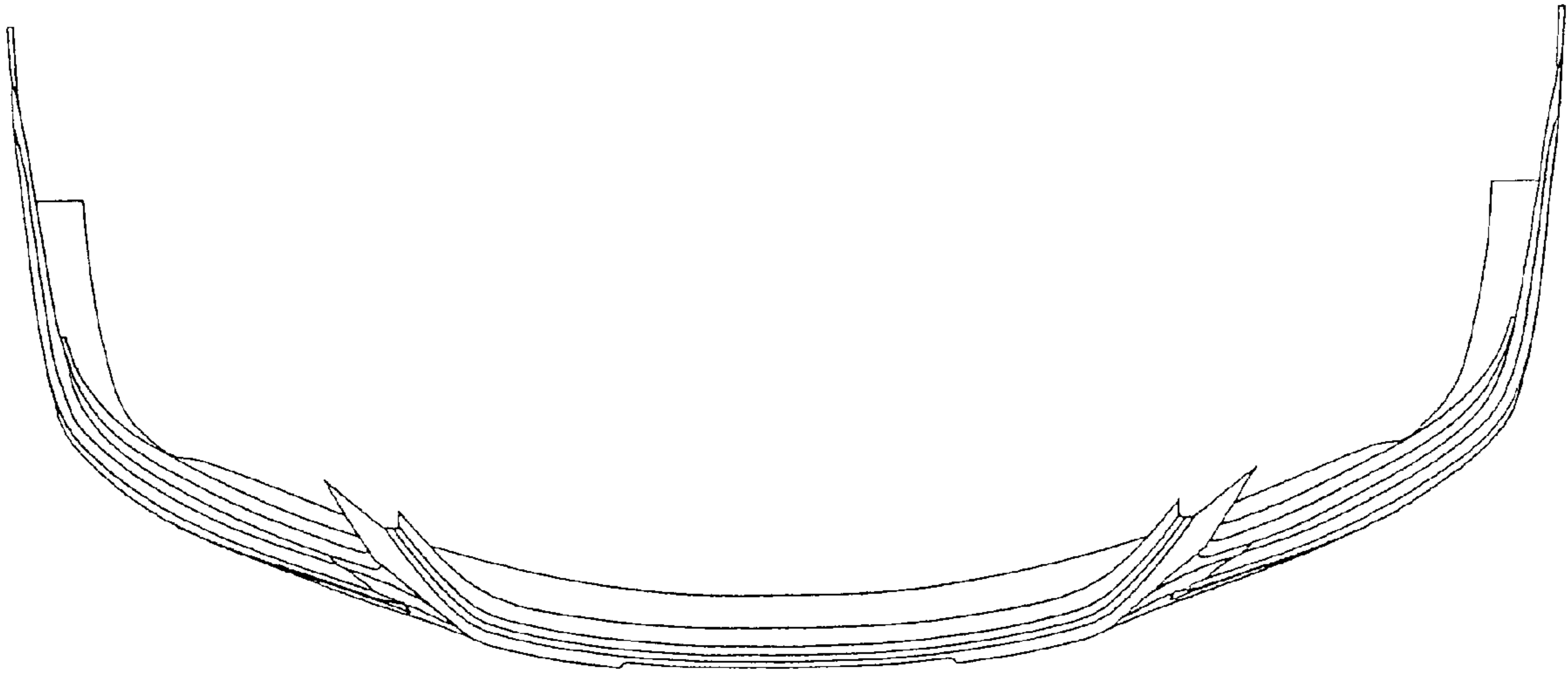

FIG. 4

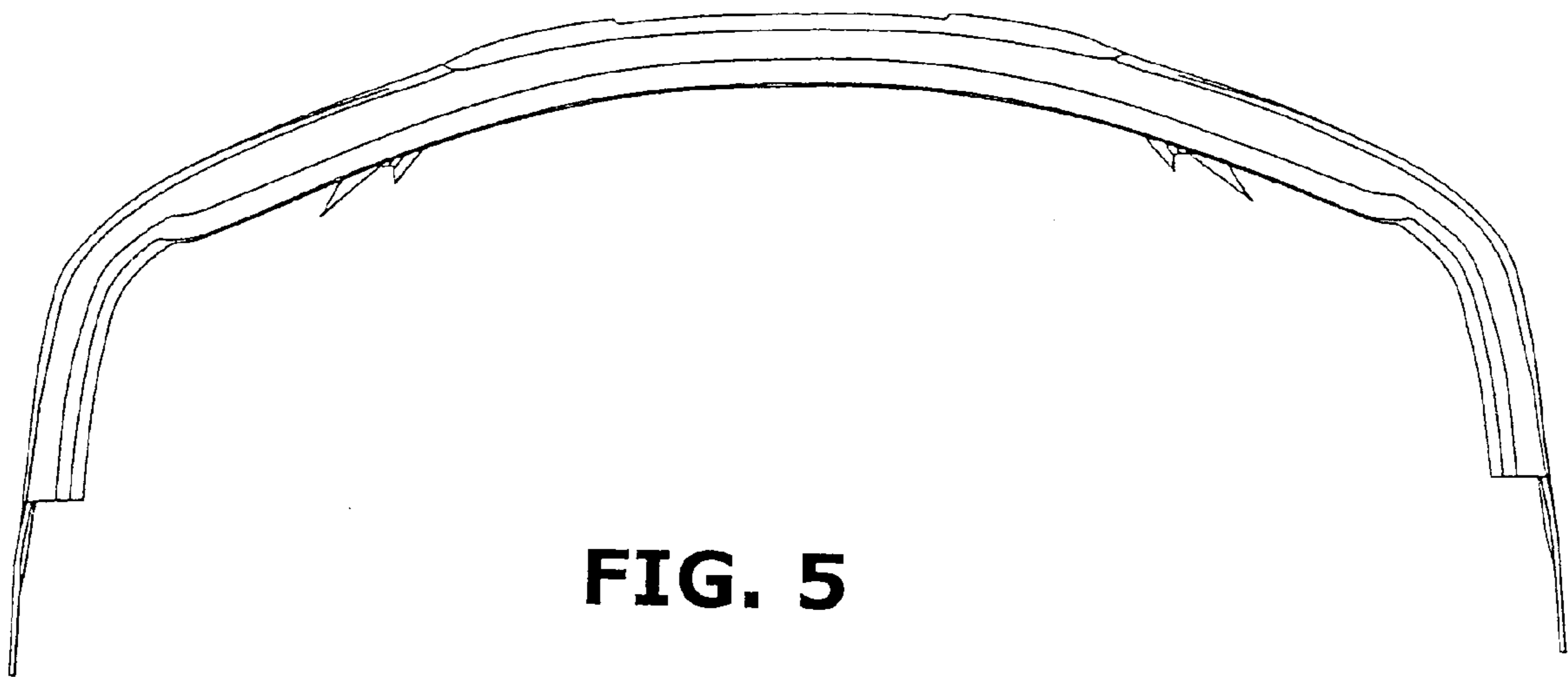

FIG. 5

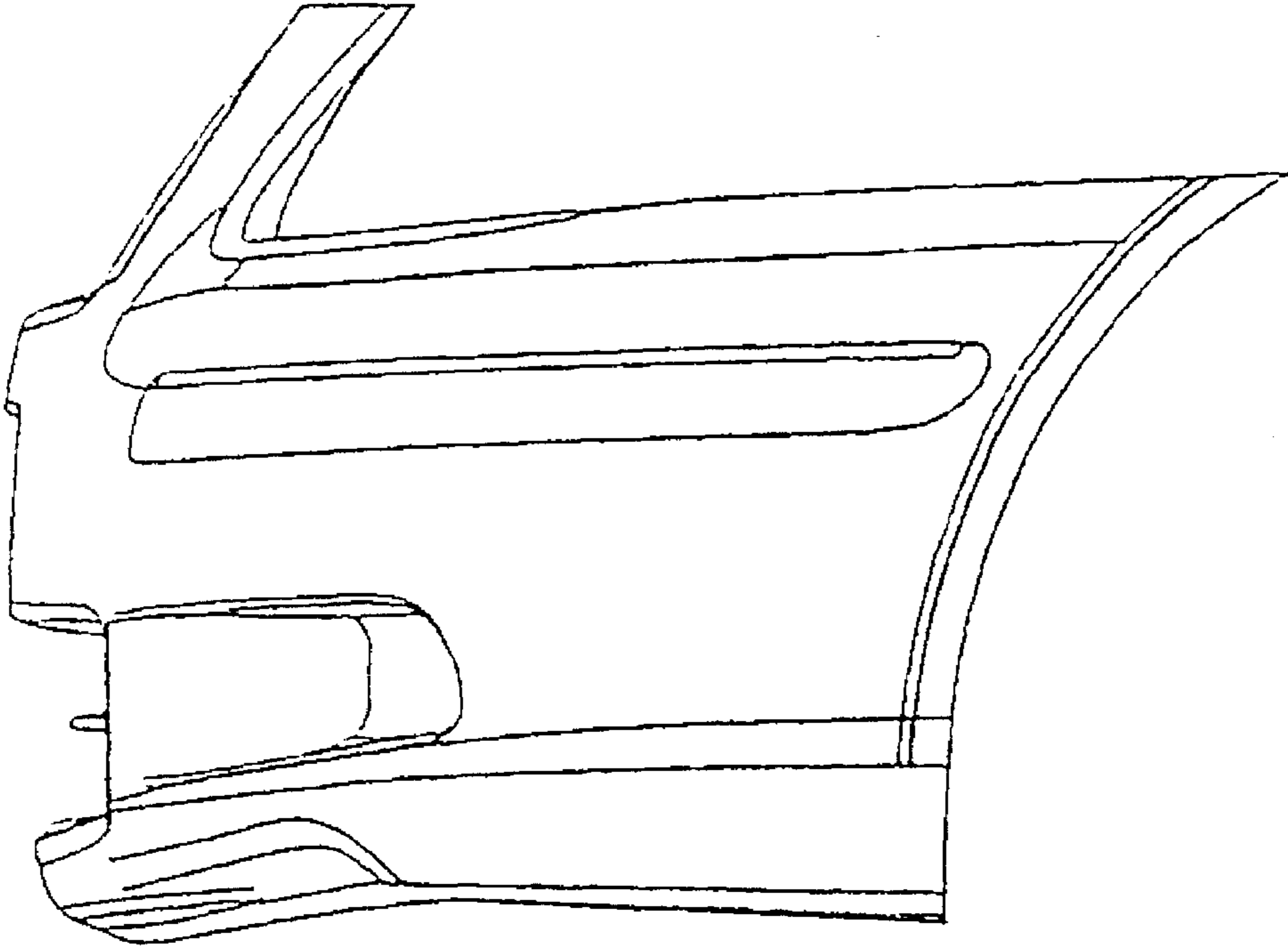

FIG. 6