



US00D516370S

(12) **United States Design Patent**  
**Tsujita**

(10) **Patent No.:** **US D516,370 S**  
(45) **Date of Patent:** **\*\* Mar. 7, 2006**

- (54) **MICROWAVE OVEN**
- (75) **Inventor:** **Yuhsuke Tsujita, Osaka (JP)**
- (73) **Assignee:** **Sharp Kabushiki Kaisha, Osaka (JP)**
- (\*\*) **Term:** **14 Years**
- (21) **Appl. No.:** **29/212,852**
- (22) **Filed:** **Sep. 9, 2004**
- (30) **Foreign Application Priority Data**  
Mar. 10, 2004 (JP) ..... 2004-007126
- (51) **LOC (8) Cl. .... 07-02**
- (52) **U.S. Cl. .... D7/351**
- (58) **Field of Classification Search ..... D7/350.1,**  
**D7/350.3, 350.4, 351, 402, 405; 219/756-758,**  
**219/378, 19 M, 275 E**  
See application file for complete search history.

D368,406 S	4/1996	Nakamura	
D371,041 S	6/1996	Matoba et al.	
D373,502 S	9/1996	Fujii et al.	
D380,644 S	7/1997	Tsuda et al.	
D390,411 S	2/1998	Nakagawa	
D390,412 S	2/1998	Takimoto	
D410,813 S	6/1999	Fujii	
D411,074 S	6/1999	Sakai et al.	
D411,706 S	6/1999	Koike	
D425,750 S	5/2000	Koike	
D426,102 S	6/2000	Hamada et al.	
D435,999 S	* 1/2001	Noda et al. ....	D7/351
D439,794 S	* 4/2001	Paul .....	D7/351
D442,008 S	* 5/2001	Noda et al. ....	D7/351
D442,821 S	* 5/2001	Naganuma .....	D7/351
D455,932 S	* 4/2002	Noda et al. ....	D7/351
D468,578 S	* 1/2003	Fukuda et al. ....	D7/351
D476,521 S	* 7/2003	Fukuda et al. ....	D7/351
D477,964 S	* 8/2003	Kanza .....	D7/351

\* cited by examiner

*Primary Examiner*—Ruth McInroy  
(74) *Attorney, Agent, or Firm*—Nixon & Vanderhye P.C.

(56) **References Cited**  
**U.S. PATENT DOCUMENTS**

D304,412 S	* 11/1989	Nishibori .....	D7/351
D310,764 S	* 9/1990	Nishikawa .....	D7/351
D329,353 S	9/1992	Yamada	
D334,688 S	4/1993	Kitae et al.	
D335,064 S	4/1993	Sugiyama et al.	
D341,289 S	11/1993	Choi	
D352,636 S	11/1994	Nakamura	
D353,510 S	12/1994	Nakamura	
D353,511 S	12/1994	Saimen	
D353,512 S	12/1994	Saimen et al.	
D356,006 S	3/1995	Saimen et al.	
D357,159 S	4/1995	Mitsui et al.	
D367,991 S	3/1996	Saimen	
D367,992 S	3/1996	Saimen	
D368,405 S	4/1996	Tada	

(57) **CLAIM**

The ornamental design for a microwave oven, as shown and described.

**DESCRIPTION**

FIG. 1 is a top, front and right side perspective view of a microwave oven according to my design; FIG. 2 is a front elevational view thereof; FIG. 3 is a rear elevational view thereof; FIG. 4 is a top plan view thereof; FIG. 5 is a bottom plan view thereof; FIG. 6 is a right side elevational view thereof; and, FIG. 7 is a left side elevational view thereof.

**1 Claim, 6 Drawing Sheets**

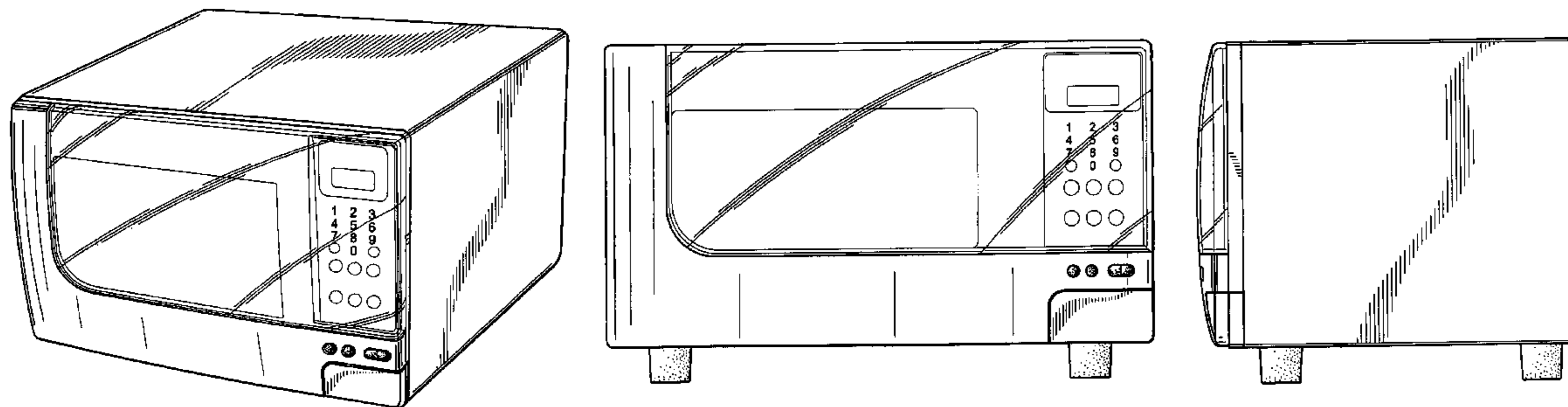

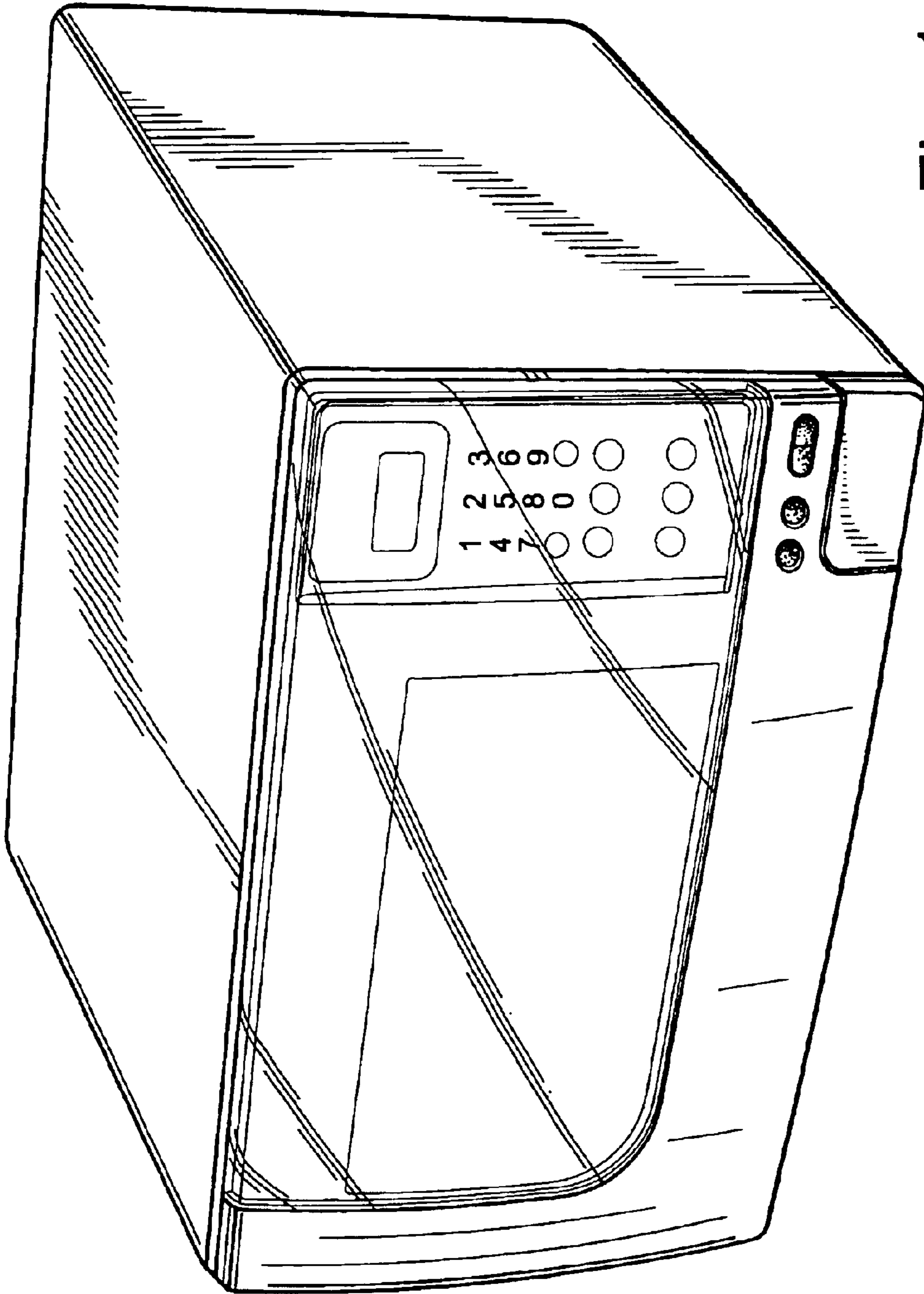

Fig. 1

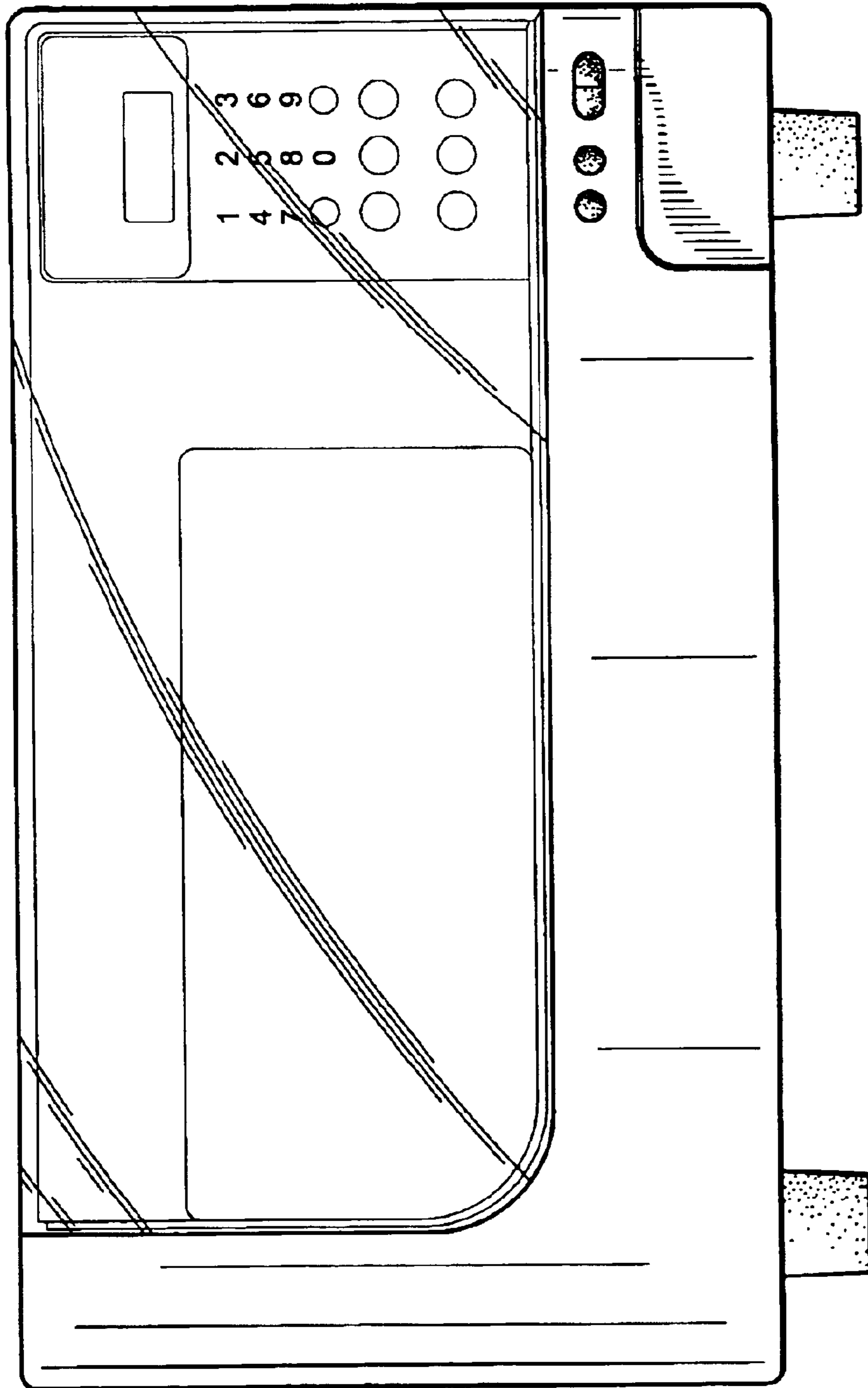

Fig. 2

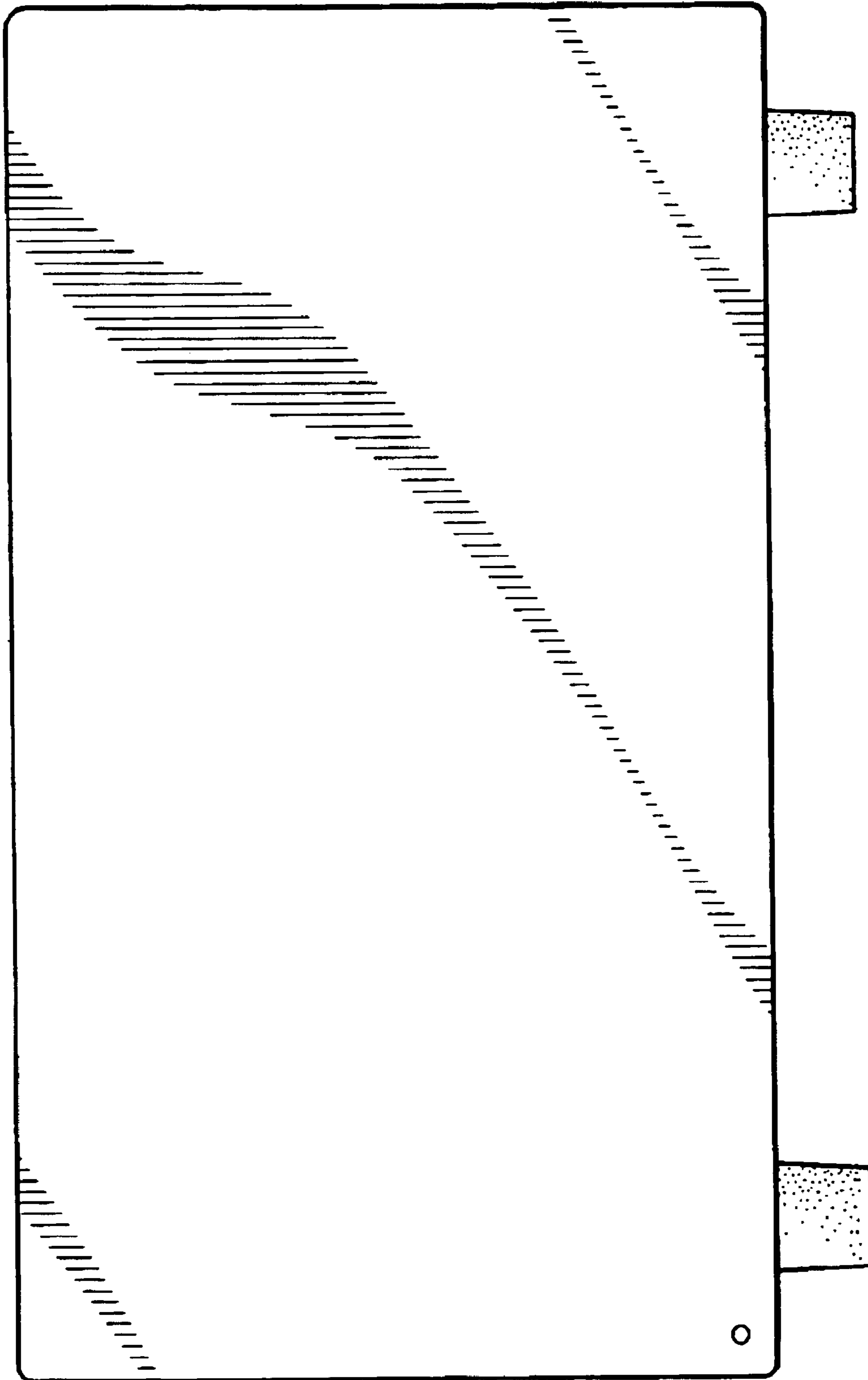

Fig. 3

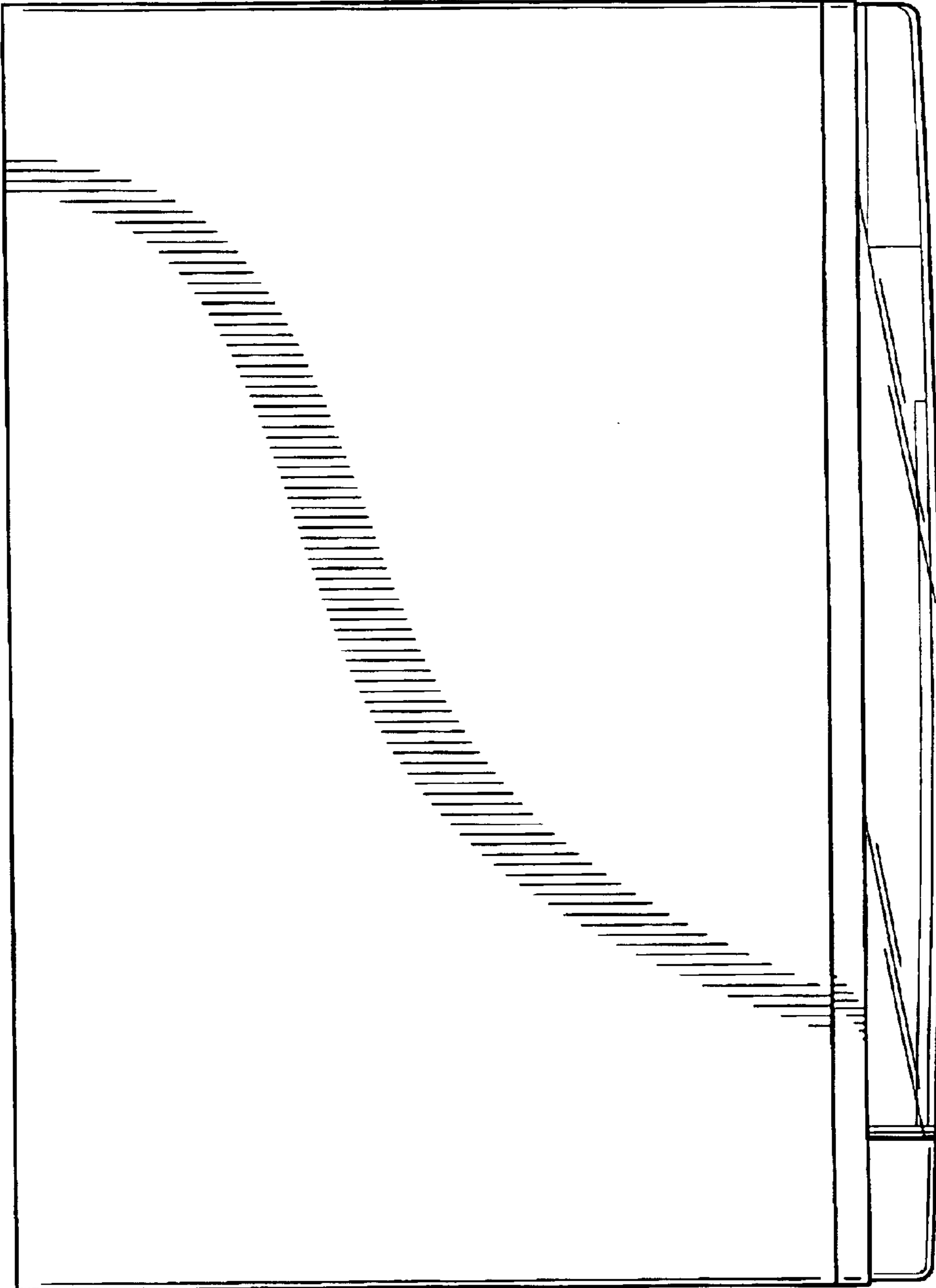

Fig. 4

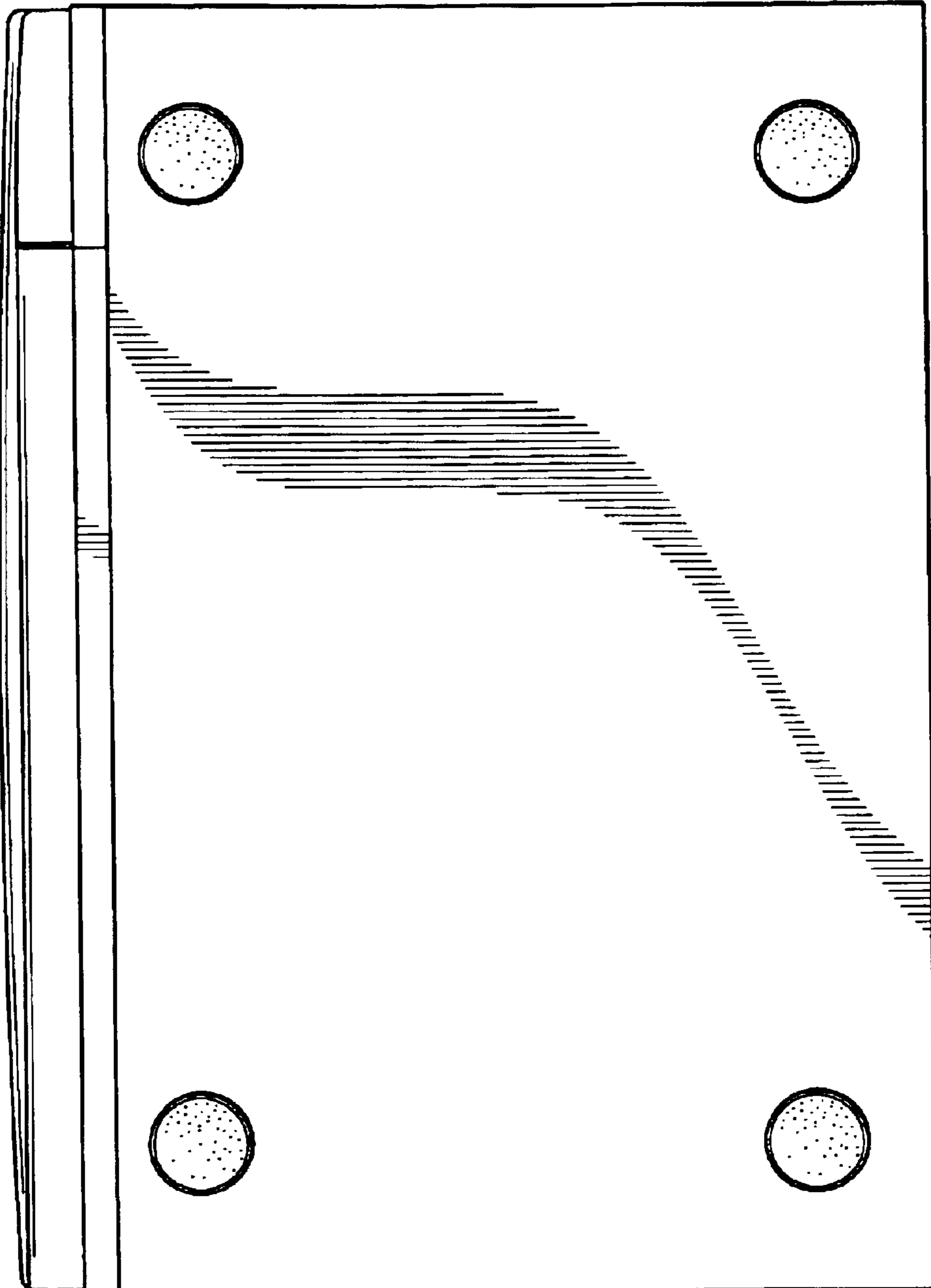

Fig. 5

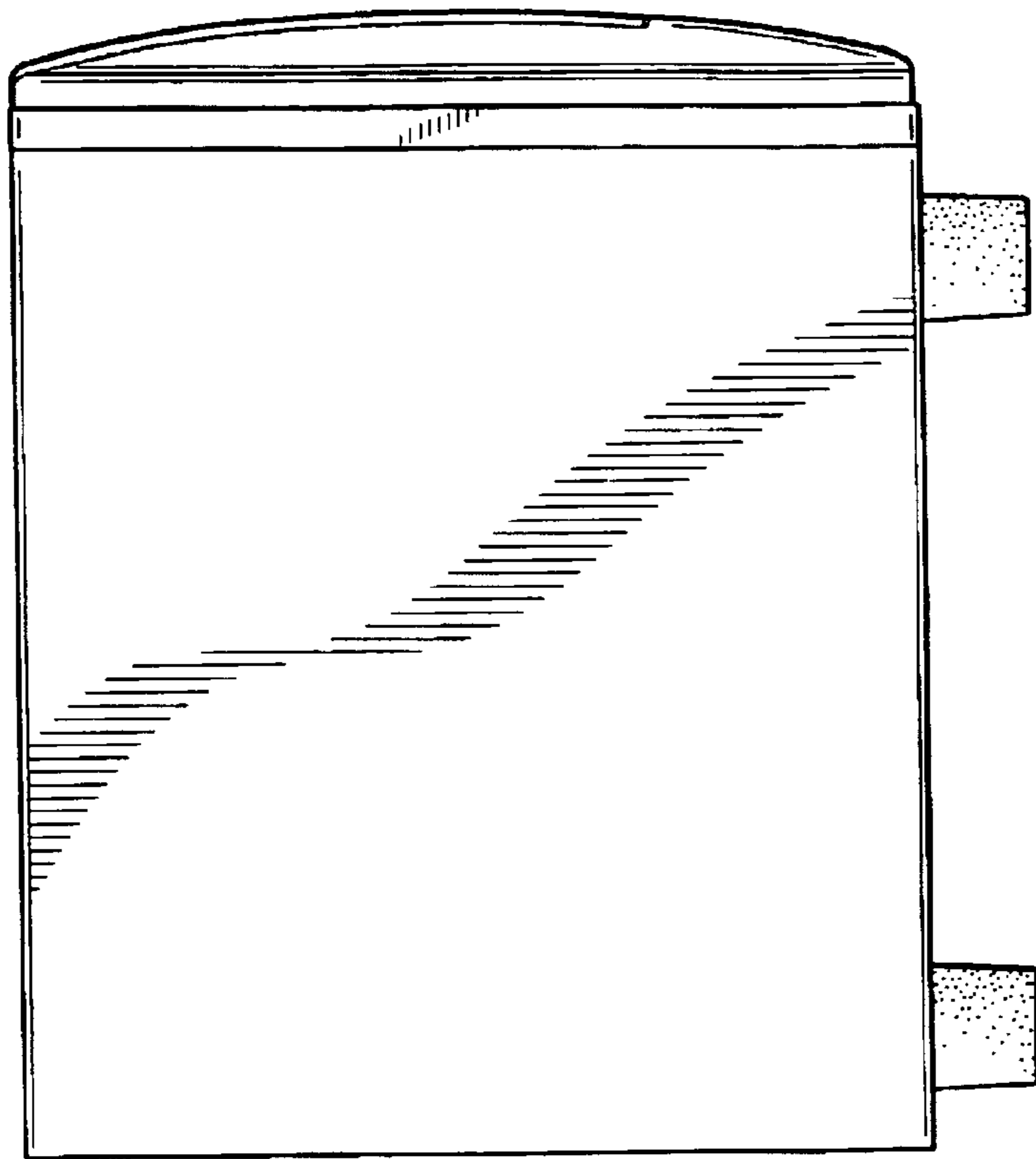

Fig. 7

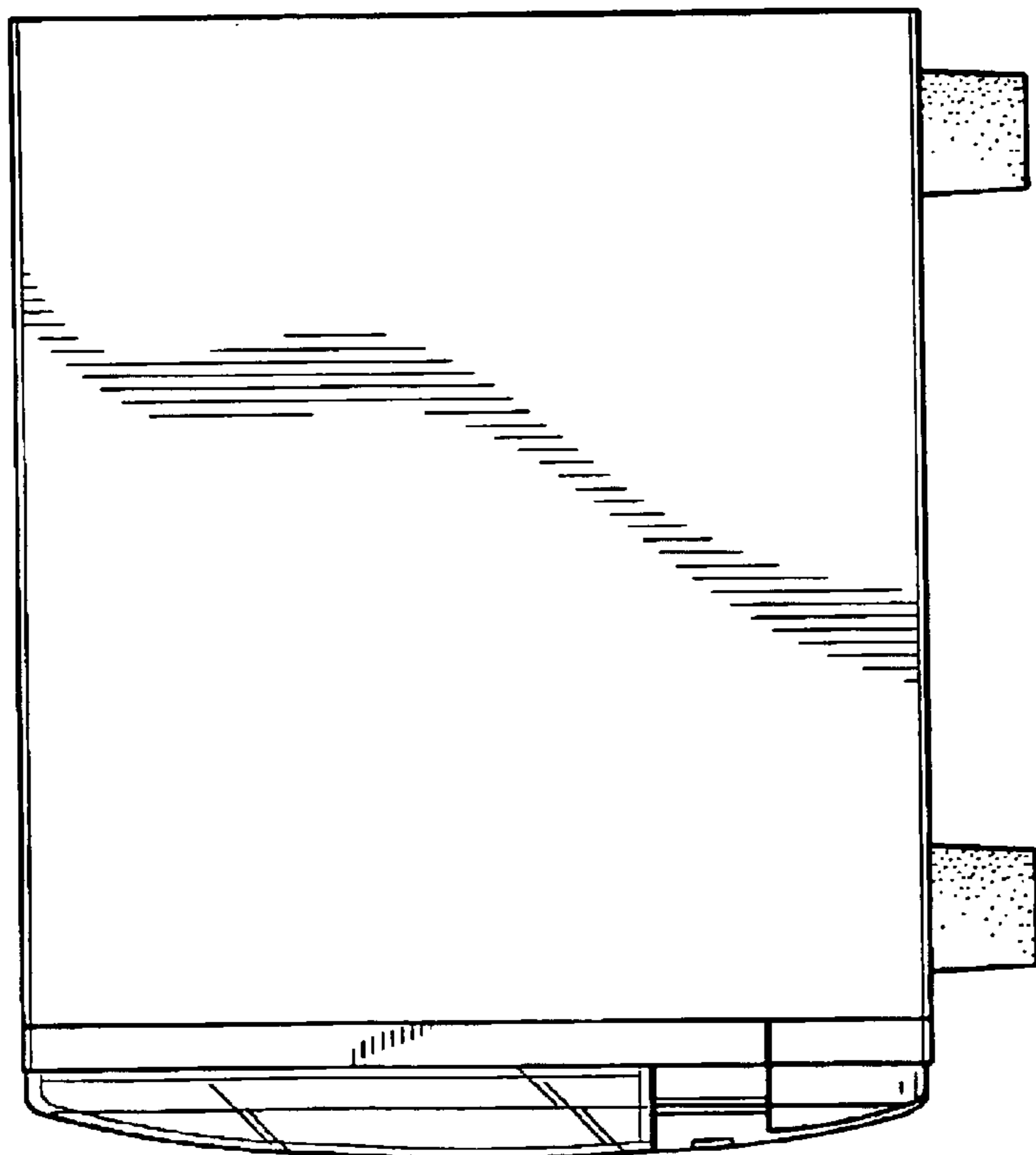

Fig. 6