



US00D516360S

(12) **United States Design Patent** (10) **Patent No.:** **US D516,360 S**  
**Henning** (45) **Date of Patent:** **\*\* Mar. 7, 2006**

(54) **BASEBALL AREA PROTECTOR**

Austintown Fence Company. "Austintown Fence Company: Product Catalog" <<http://www.afencecompany.com>>.

(75) Inventor: **William W. Henning**, Longboat Key, FL (US)

(Continued)

(73) Assignee: **Aer-Flo Canvas Products, Inc.**, Bradenton, FL (US)

*Primary Examiner*—Holly Baynham  
(74) *Attorney, Agent, or Firm*—Jacox Meckstroth & Jenkins

(\*\*) Term: **14 Years**

(57) **CLAIM**

(21) Appl. No.: **29/206,371**

The ornamental design for a baseball area protector, as shown and described.

(22) Filed: **May 27, 2004**

**Related U.S. Application Data**

**DESCRIPTION**

(63) Continuation-in-part of application No. 10/722,287, filed on Nov. 25, 2003.

(51) **LOC (8) Cl.** ..... **06-11**

(52) **U.S. Cl.** ..... **D6/592**

(58) **Field of Classification Search** ..... D6/592;  
D21/780; 428/82; D32/40; 15/230, 215–217  
See application file for complete search history.

FIG. 1 is a top plan view of a baseball area protector;  
FIG. 2 is a right side view of the embodiment shown in FIG. 1 with the front, rear and left side views being mirror images;

FIG. 3 is a bottom view of the embodiment shown in FIG. 1;

FIG. 4 is a top plan view of a second embodiment of the invention;

FIG. 5 is a front view of the embodiment shown in FIG. 4 with the rear view being a mirror image;

FIG. 6 is a right side view of the embodiment shown in FIG. 4 with the left side view being a mirror image;

FIG. 7 is a bottom view of the embodiment shown in FIG. 4;

FIG. 8 is a top plan view of a third embodiment of the invention;

FIG. 9 is a right side view of the embodiment shown in FIG. 8 with the left side view, front view and rear view being mirror images;

FIG. 10 is a bottom view of the embodiment shown in FIG. 8;

FIG. 11 is a fragmentary sectional view of the embodiments shown in FIGS. 1–7; and,

FIG. 12 is a fragmentary sectional view of the embodiments shown in FIGS. 8–11.

The views of FIGS. 11 and 12 are shown fragmented for clarity of illustration.

(56) **References Cited**

**U.S. PATENT DOCUMENTS**

1,216,488	A	*	2/1917	Pfeiffer	.....	15/230
3,862,876	A		1/1975	Graves		
4,272,575	A		6/1981	Egigian		
4,580,372	A		4/1986	Osborn		
4,634,618	A		1/1987	Greer et al.		
4,682,447	A		7/1987	Osborn		
4,690,585	A		9/1987	Holmberg		
4,889,446	A		12/1989	Holmberg		
4,961,981	A		10/1990	Keegan		
5,364,156	A		11/1994	Zerow		
5,579,610	A		12/1996	Jackson		
D379,081	S		5/1997	Wilson		
D389,451	S		1/1998	Wilson		
D414,643	S	*	10/1999	Phua	.....	D6/592
6,363,661	B1		4/2002	Myers		
6,394,528	B1		5/2002	Hoenack		

**OTHER PUBLICATIONS**

American Athletic. "Windscreens & Field Covers—American Athletic Baseball and Softball—Equipment, Pro" <<http://www.aaibaseball.com/covers:htm>>.

**1 Claim, 4 Drawing Sheets**

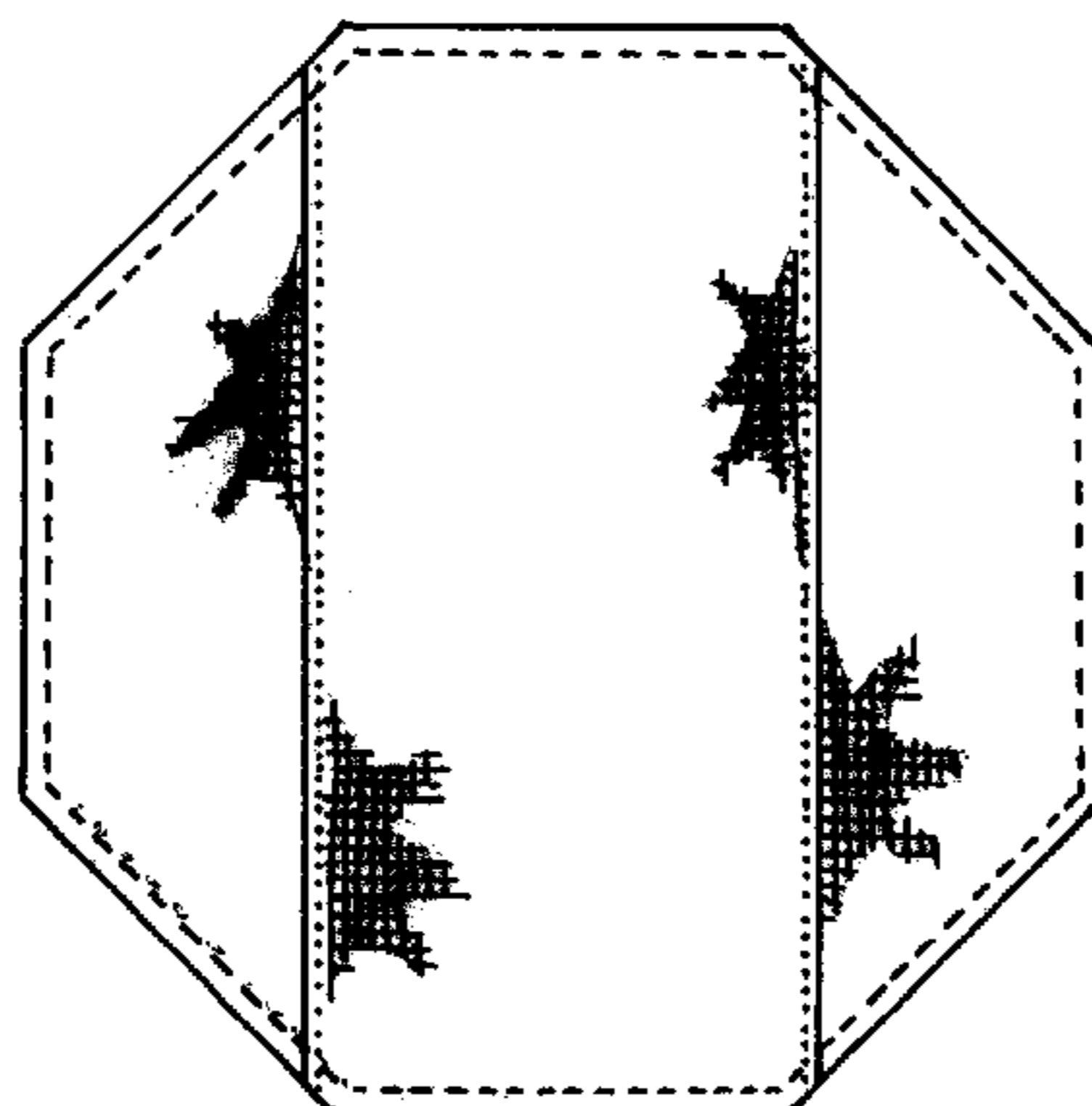

OTHER PUBLICATIONS

BSN Sports. “esportsonline—9013” <<http://www.ssgecom.com>>.

Cover Sports USA. “Athletic Field Cover—Cover Sports USA”. <<http://www.coversports.biz/fieldsaver.html>>.

Covermaster Inc. “Covermaster—Masters in the Art of Sports Surface Covers—Seat covers, Windscreen”. <<http://www.covermaster.com>>.

Douglas Industries. “Douglas Field Covers & Infield Grass Protectors” <<http://www.Douglas-sports.com/BsCovers.htm>>.

Hoover Fence Co. “Baseball/Softball—Field Maintenance Equipment.” <<http://www.hooverfence.com/sports/baseball-softball/tarps.htm>>.

J.A.Cissel Mfg. Co. “Courtmaster Baseball Field Covers & Fencing” <<http://www.jacissel.net>>.

Mid America Sales Associates. Your Total Sport Source. “Shop Baseball.” <<http://www.masa.com>>.

M. Putterman. “M. Putterman Vinyl Covers” Friday, Sep. 19, 2003 <<http://www.mputterman.com/vinyl.shtml>>.

Missouri Turf Paint and Field Graphics. “Field Covers for Baseball and Softball.” <[http://www.missouriturfpaint.com/baseball\\_cb.html](http://www.missouriturfpaint.com/baseball_cb.html)>.

NexTag. NexTag search results for Collegiate Pacific Products. <<http://www.nextag.com>>.

Online Sports.Com 20' Circular Ultra-Lite Pitcher's Mound Cover from Collegiate Pacific. <<http://www.onlinesports.com>>.

ProMounds, Inc. Baseball Field Covers. <<http://www.baseballmounds.com/fieldcovers.htm>>.

SportsMaster. “Baseball/Athletic Field Covers.” <[http://www.sportmasterinc.com/baseball\\_athletic.htm](http://www.sportmasterinc.com/baseball_athletic.htm)>.

VPI Field Covers and Fencing. “VPI Field Covers and Fences” <[http://www.sport2000.net.VPIfieldcovers\\_fencing.html](http://www.sport2000.net.VPIfieldcovers_fencing.html)>.

WeatherBeater by Colorado Lining. “CLI's WeatherBeater Athletic Field Covers and Products.” <<http://coloradolining.com/weatherbeater>>.

Fence-Top Protection. “Baseball Field Covers—Wind-screens.” CoverSports USA. Philadelphia, PA 2001 Brochure (with attached Dealer Cover Pricing Jan. 1, 2002).

\* cited by examiner

FIG-1

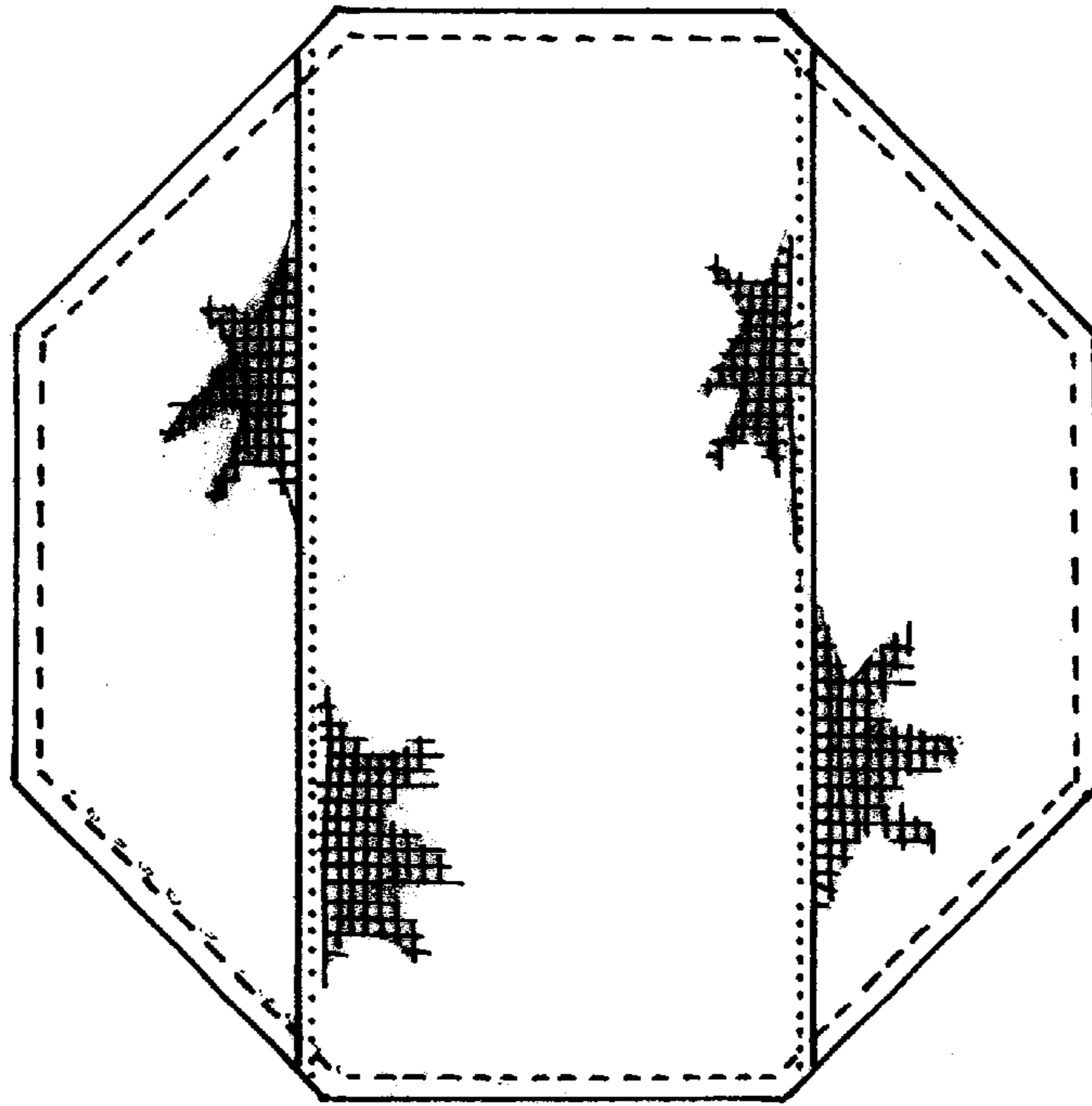

FIG-2

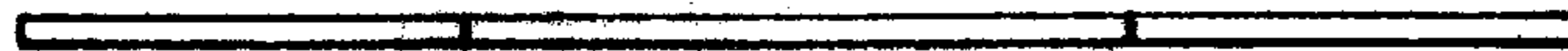

FIG-3

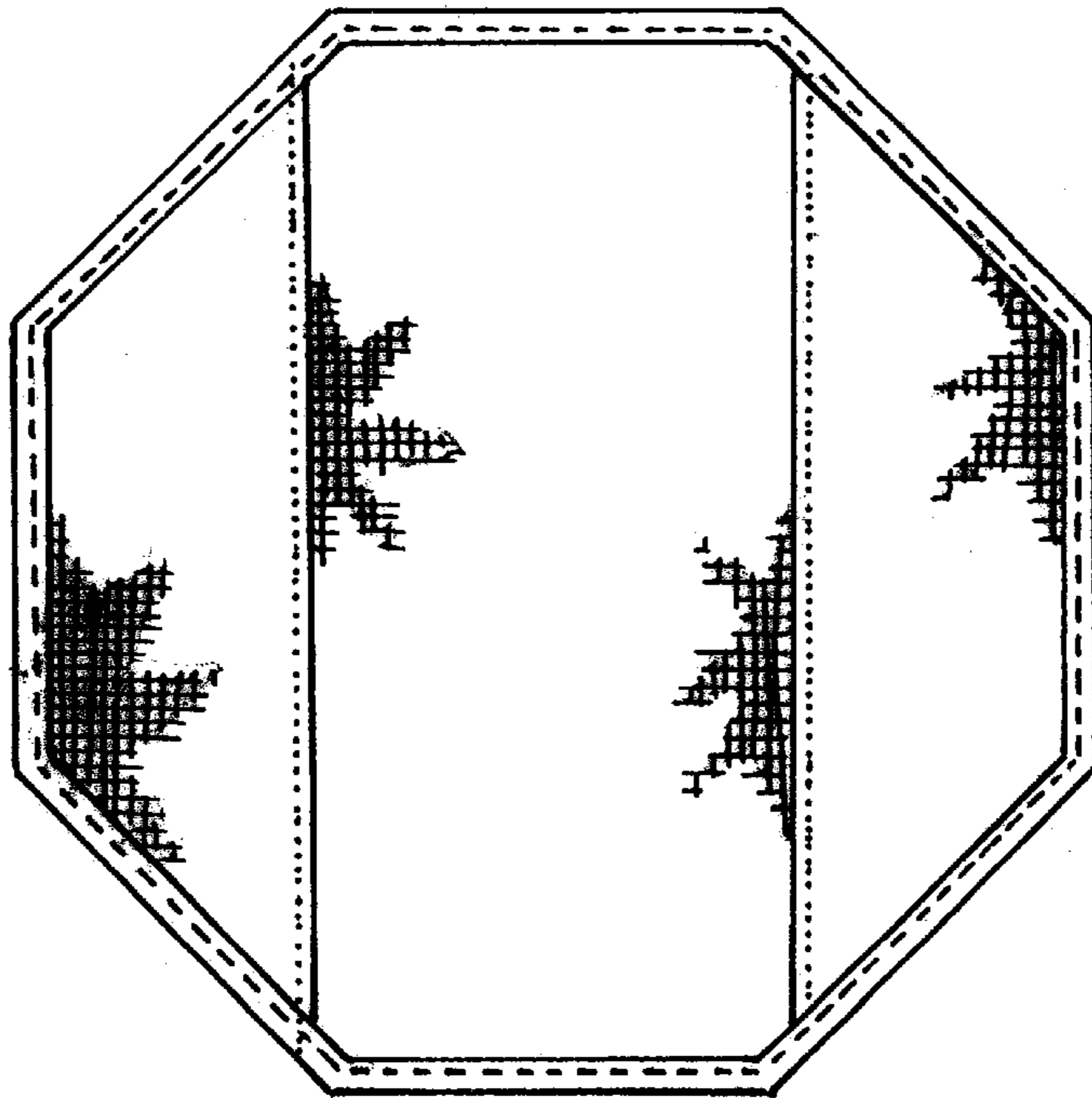

FIG-4

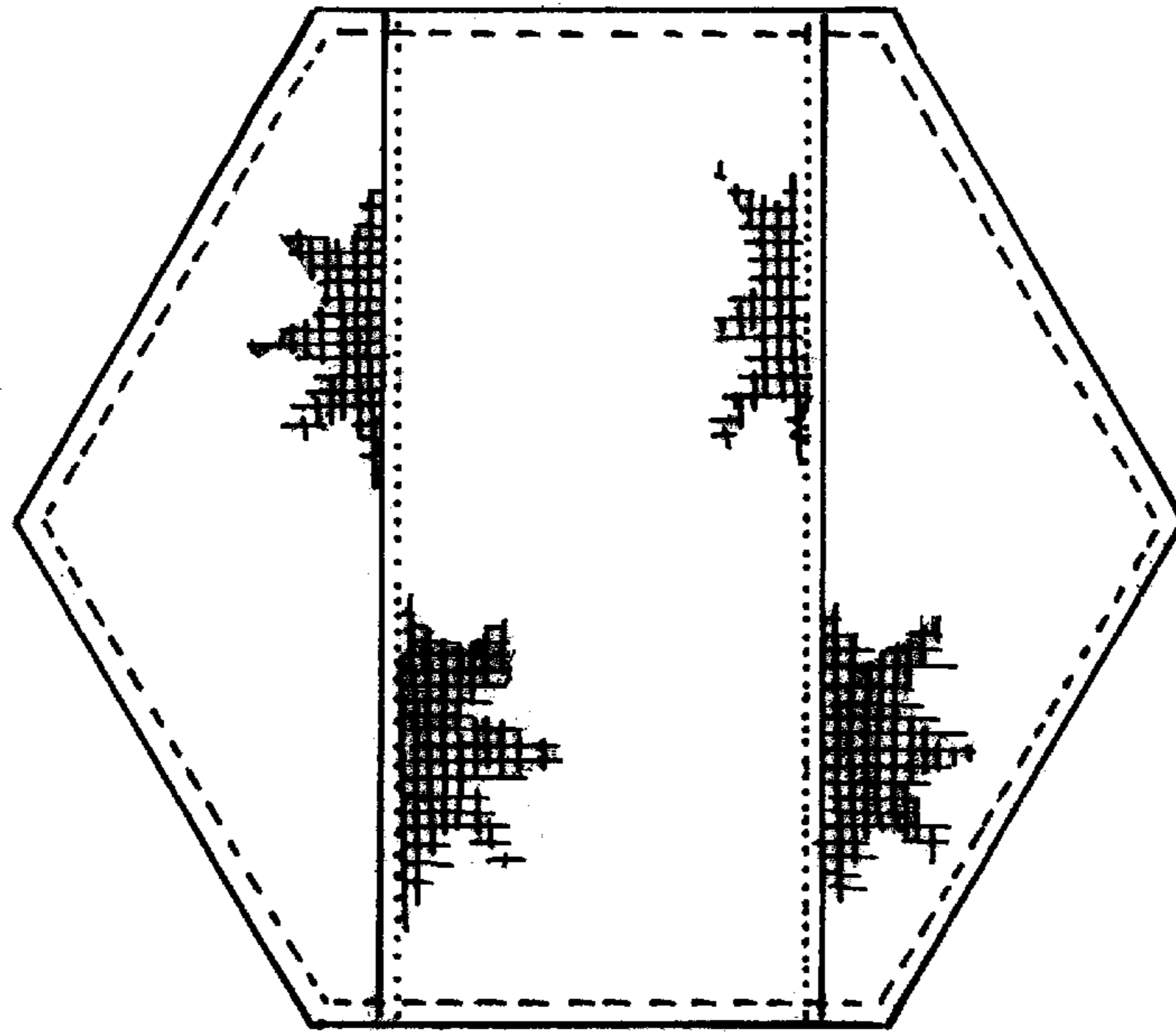

FIG-5

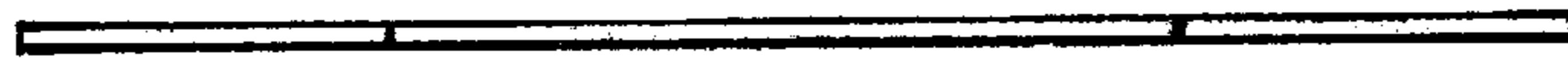

FIG-6



FIG-7

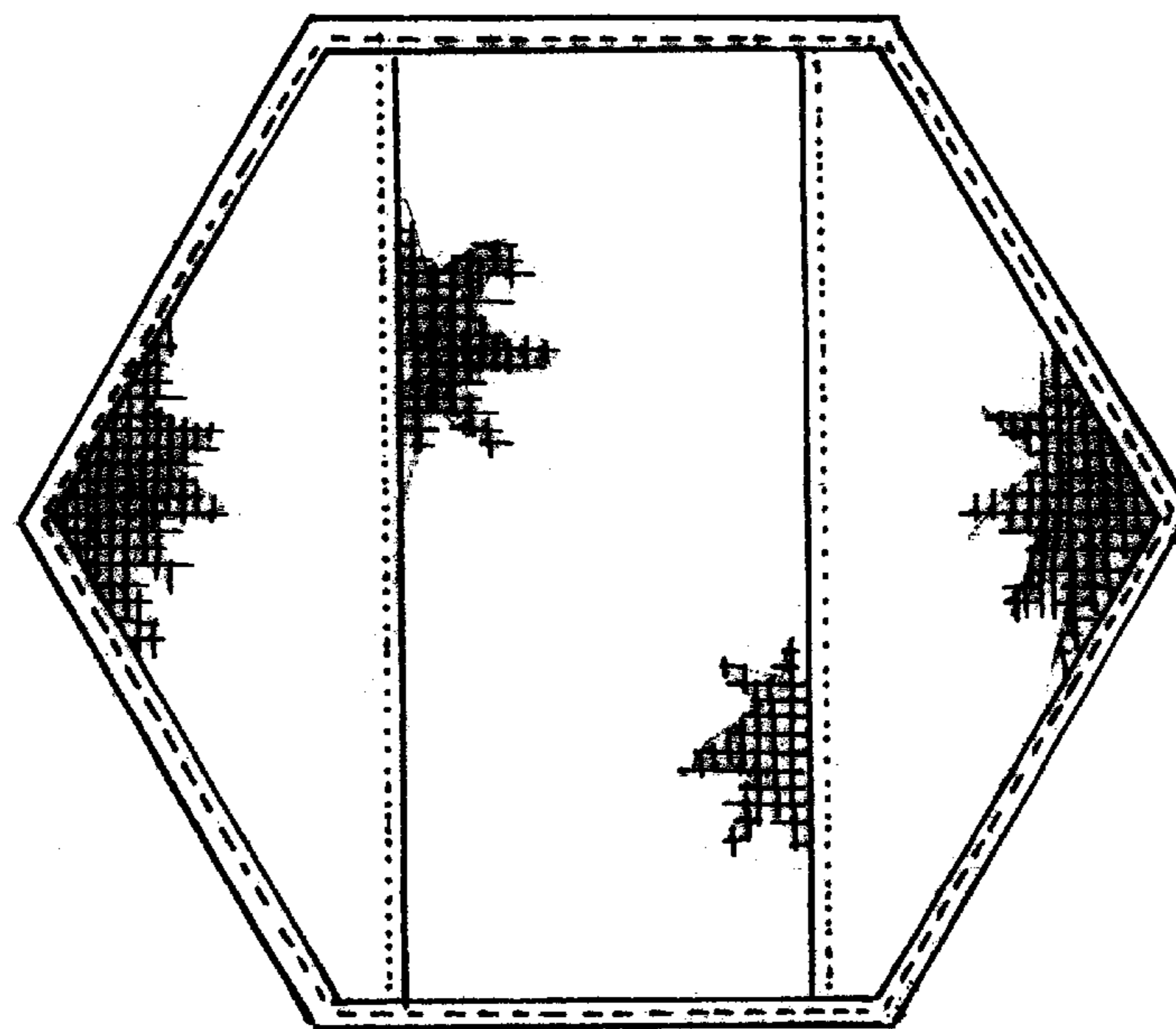

FIG-8

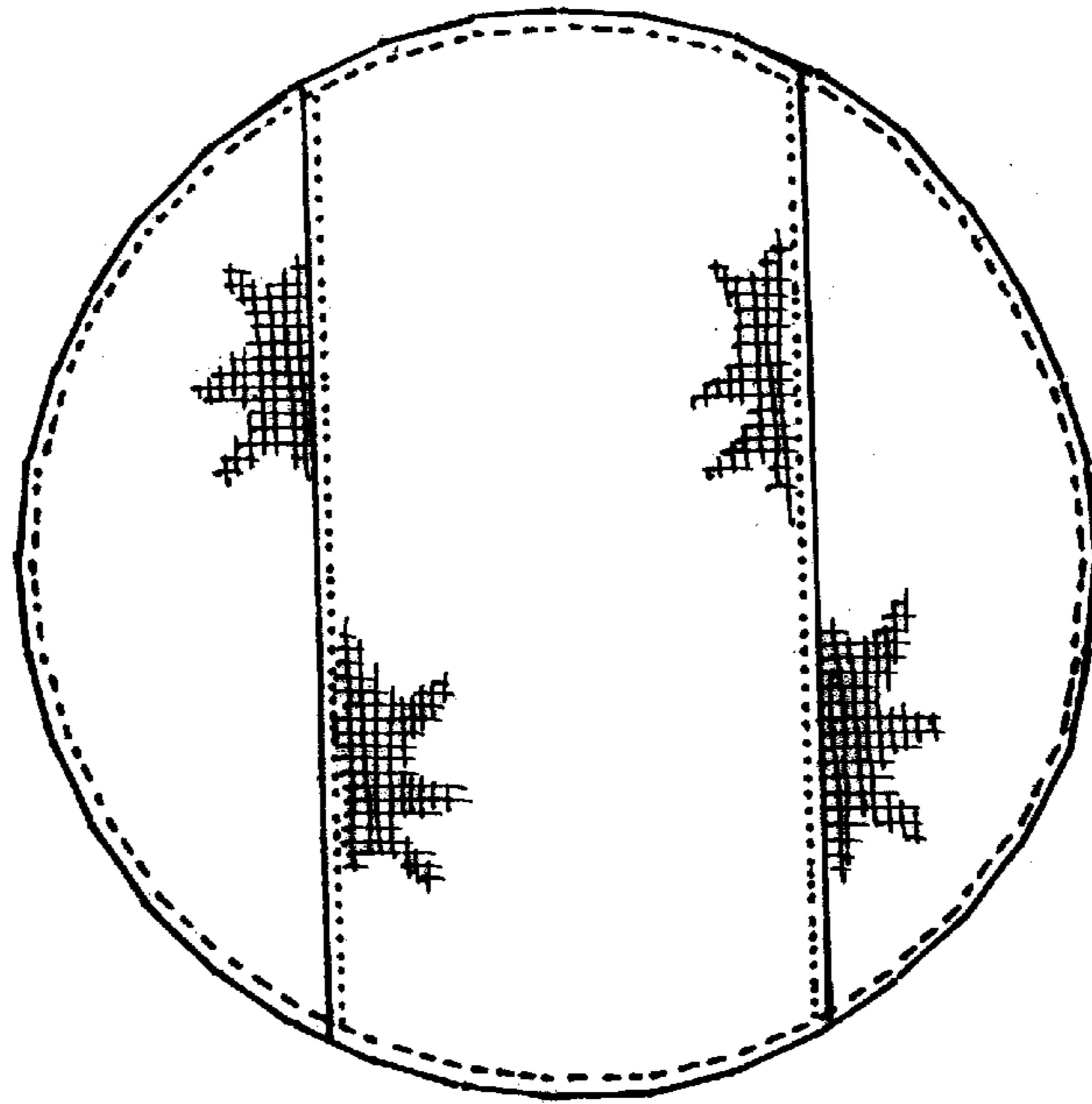

FIG-9



FIG-10

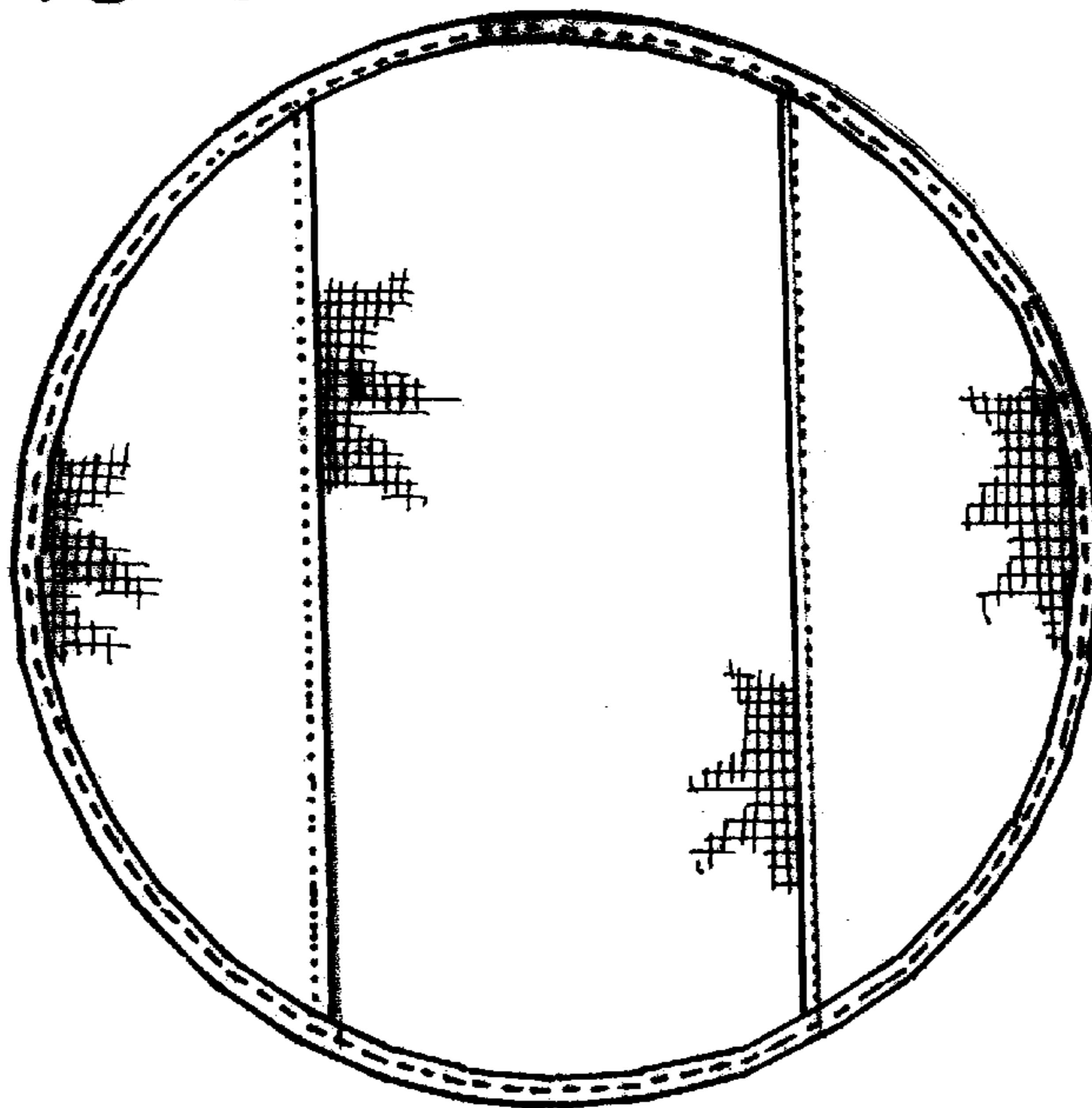

FIG-11

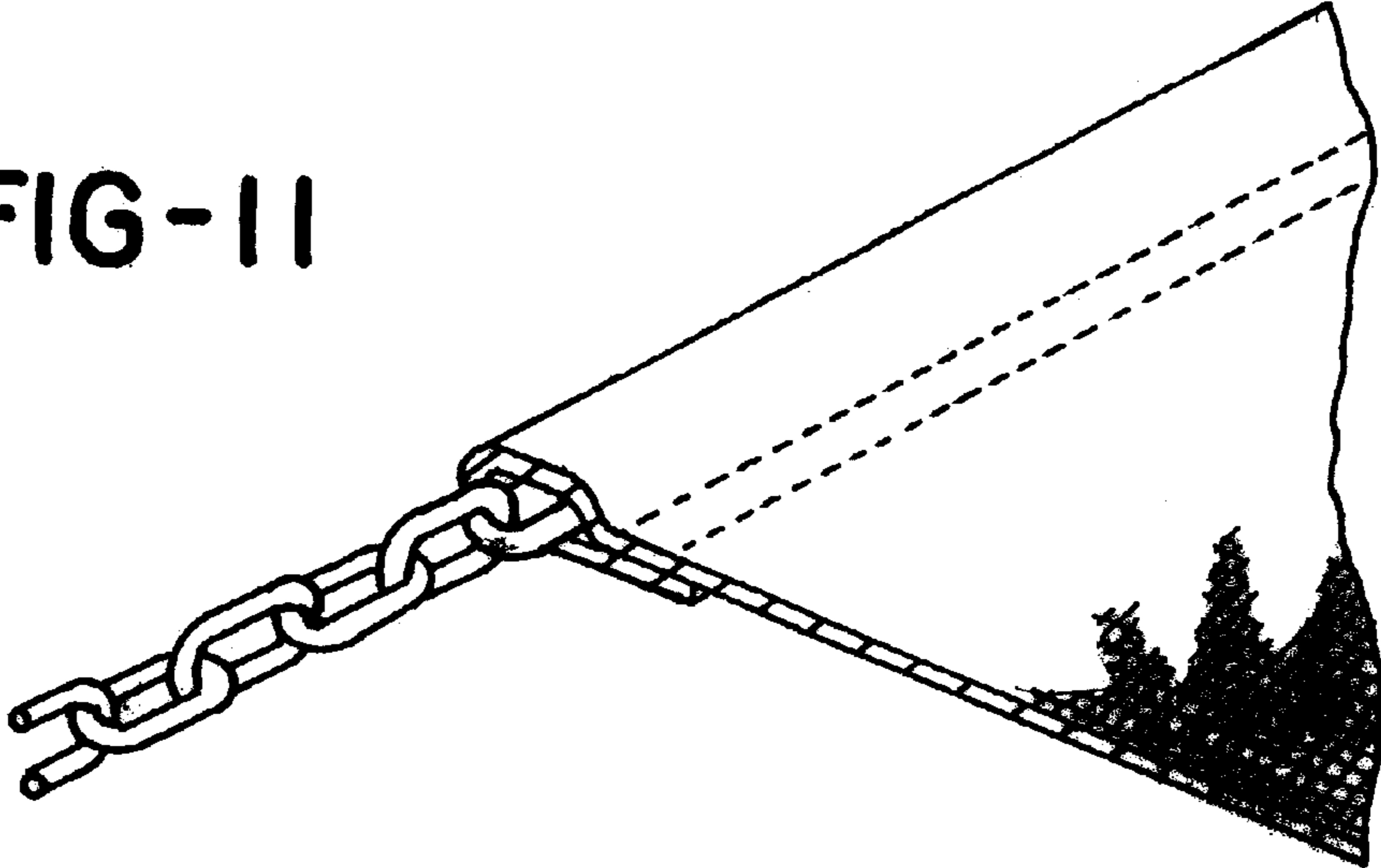
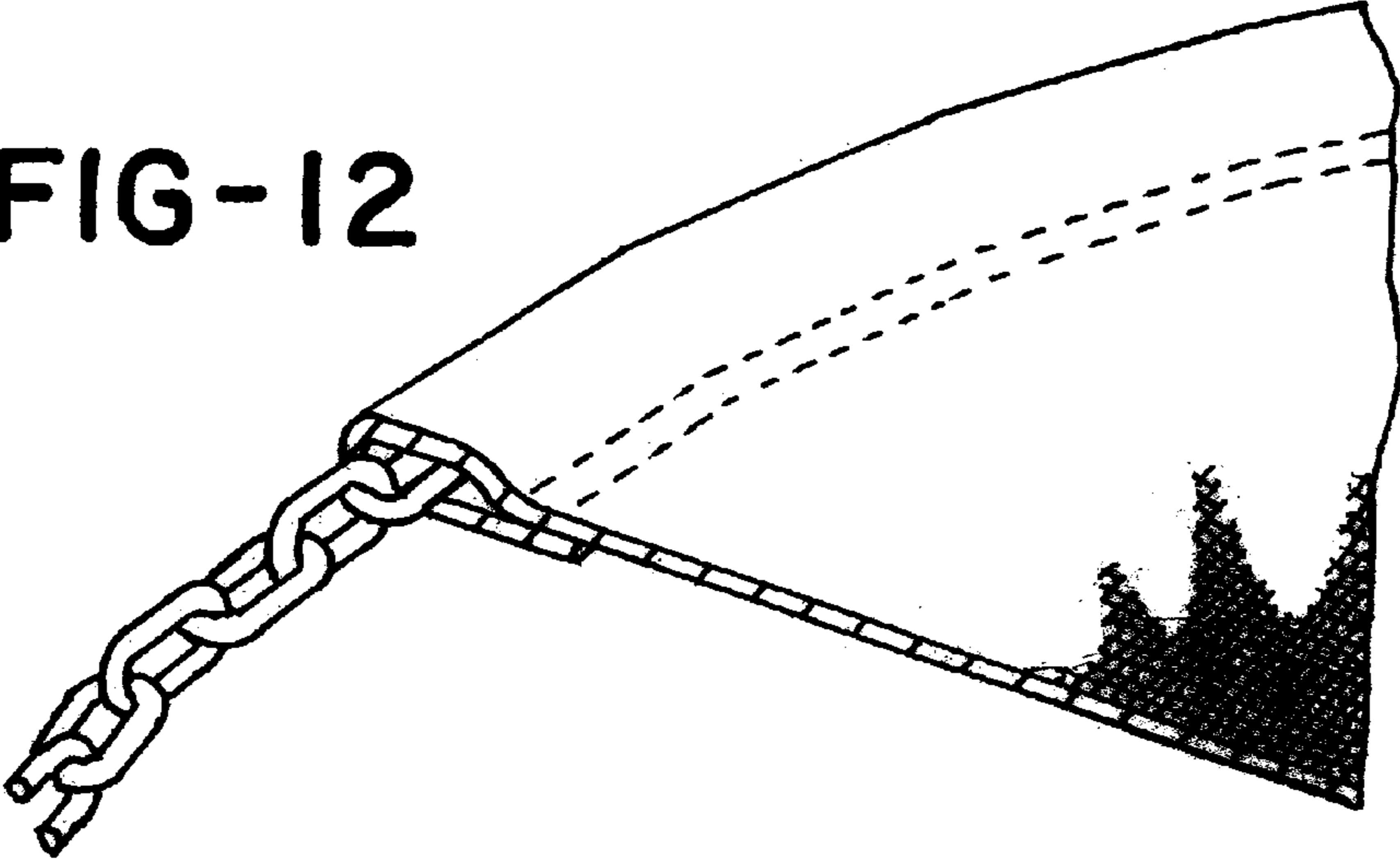

FIG-12



UNITED STATES PATENT AND TRADEMARK OFFICE  
**CERTIFICATE OF CORRECTION**

PATENT NO. : Des. 516,360 S  
APPLICATION NO. : 29/206371  
DATED : March 7, 2006  
INVENTOR(S) : William W. Henning

Page 1 of 1

It is certified that error appears in the above-identified patent and that said Letters Patent is hereby corrected as shown below:

On line 25, beginning with the language FIG. 12, delete "8-11" and insert -- 8-10 -- therefor.

In the drawings, Sheet 2, Fig. 6, a generally vertical line should be inserted between the right and left edges.

Signed and Sealed this

First Day of August, 2006

A handwritten signature in black ink on a light gray dotted background. The signature reads "Jon W. Dudas" in a cursive style.

JON W. DUDAS

*Director of the United States Patent and Trademark Office*