



US00D516201S

(12) **United States Design Patent**
Badarello

(10) **Patent No.:** **US D516,201 S**

(45) **Date of Patent:** **** Feb. 28, 2006**

(54) **CEILING FAN MOTOR HOUSING**

D467,327 S * 12/2002 Frampton D23/377

(75) Inventor: **Christophe Badarello**, Walls, MS (US)

* cited by examiner

(73) Assignee: **Hunter Fan Company**, Memphis, TN (US)

Primary Examiner—Lisa Lichtenstein

(74) *Attorney, Agent, or Firm*—Baker Donelson

(**) Term: **14 Years**

(57) **CLAIM**

(21) Appl. No.: **29/222,030**

The ornamental design for a ceiling fan motor housing, as shown and described.

(22) Filed: **Jan. 25, 2005**

DESCRIPTION

(51) **LOC (8) Cl.** **23-04**

FIG. 1 is a perspective view of a ceiling fan motor housing showing my new design.

(52) **U.S. Cl.** **D23/411**

FIG. 2 is a front view thereof.

(58) **Field of Classification Search** D23/377,

FIG. 3 is a rear view thereof.

D23/379, 385, 411; 416/5

FIG. 4 is a left side view thereof.

See application file for complete search history.

FIG. 5 is a right side view thereof.

FIG. 6 is a top view thereof; and,

FIG. 7 is a bottom view thereof.

(56) **References Cited**

The broken lines in the views show environmental features which are for illustrative purposes only and form no part of the claimed design.

U.S. PATENT DOCUMENTS

5,292,228 A * 3/1994 Dye 416/5

D435,643 S * 12/2000 Williams D23/377

1 Claim, 3 Drawing Sheets

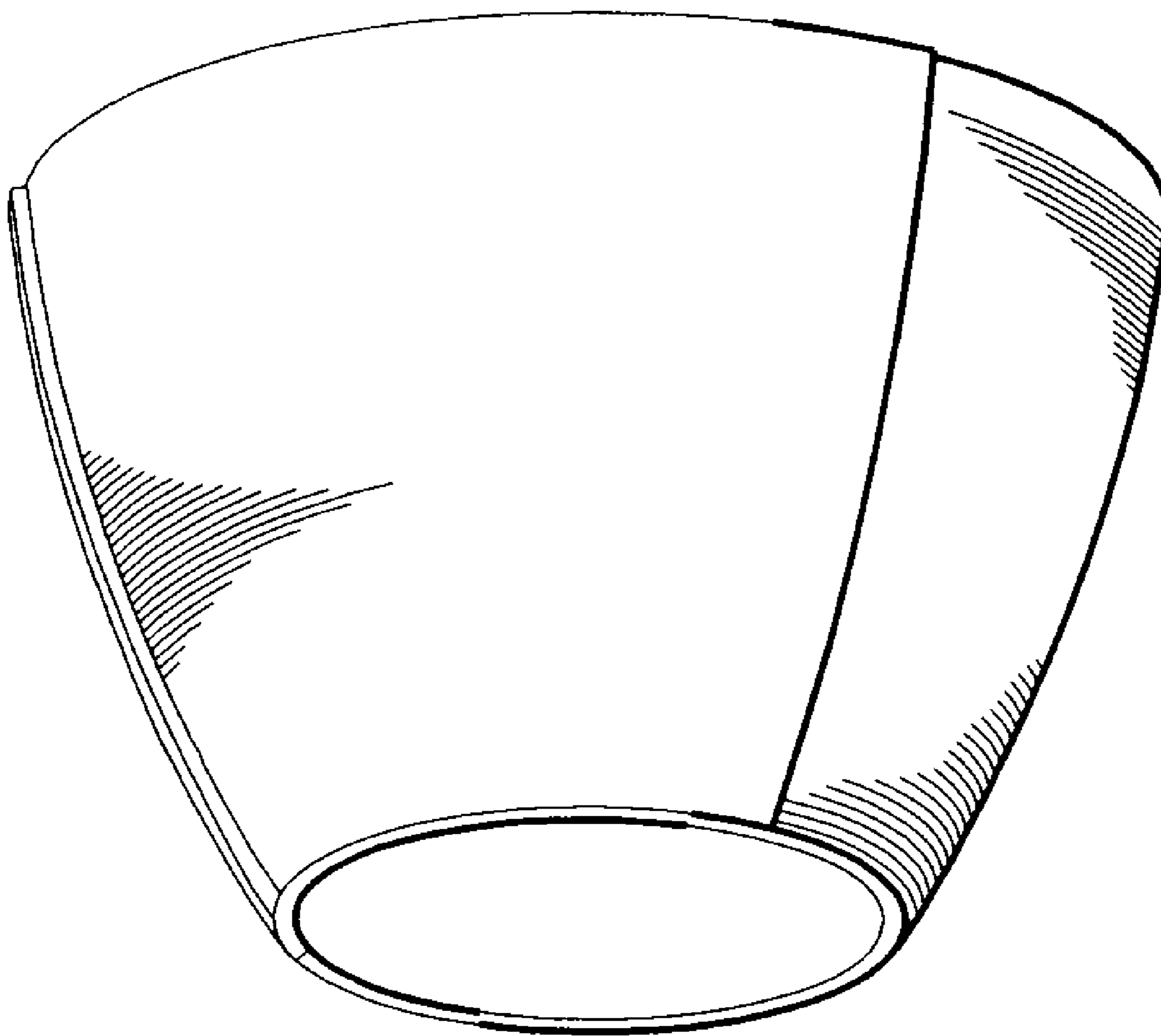

Fig. 1

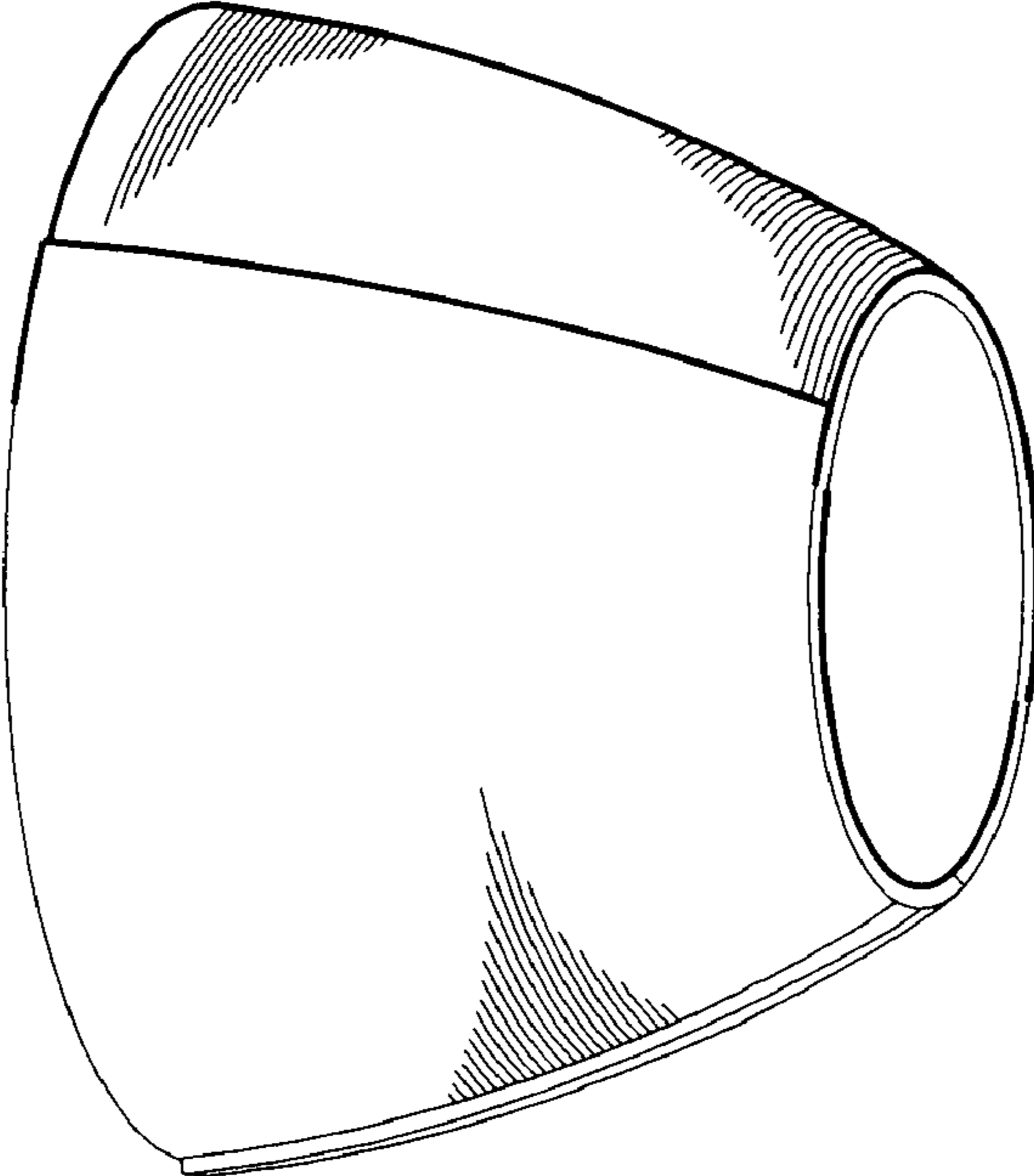

Fig. 2

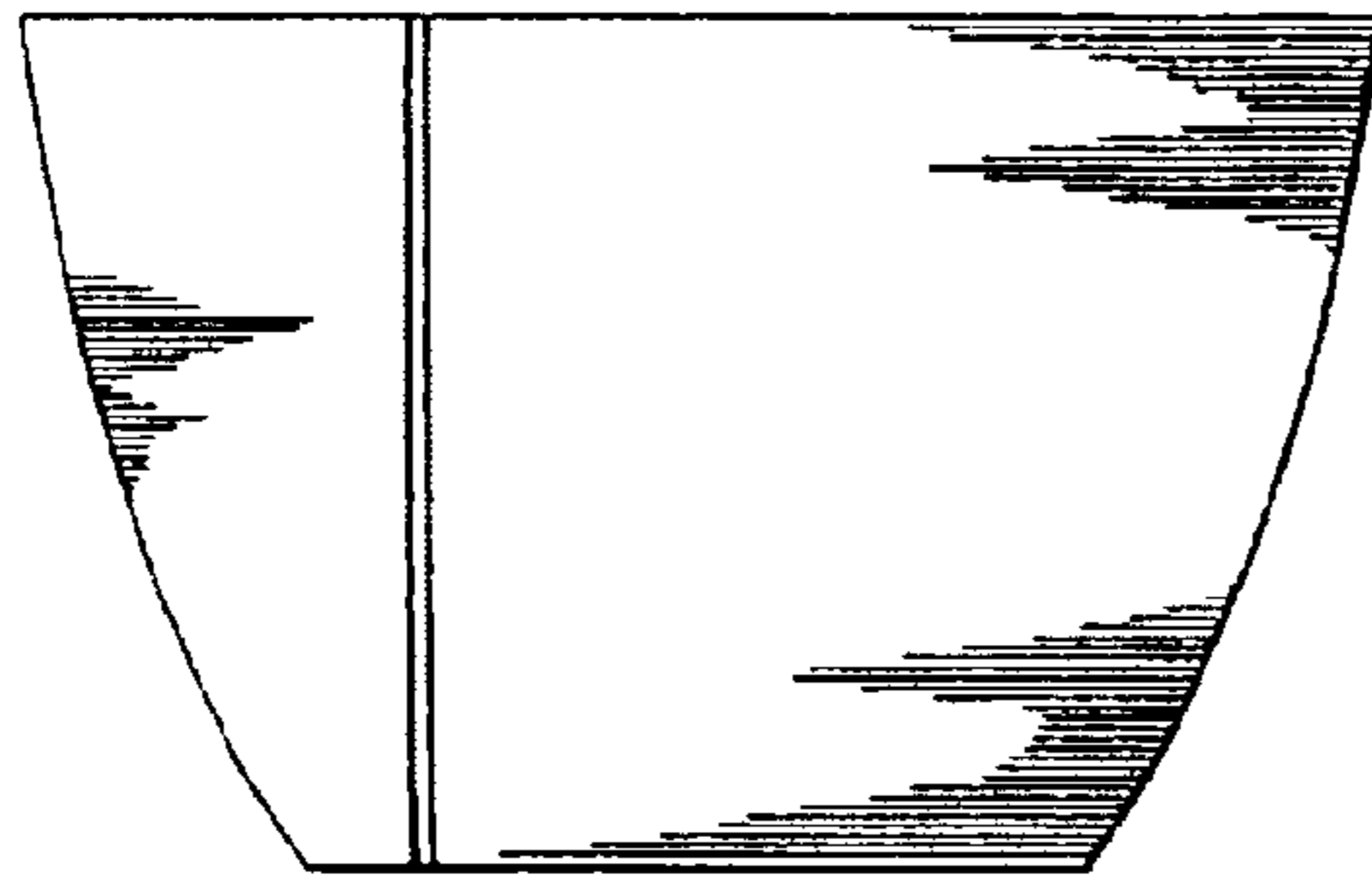

Fig. 3

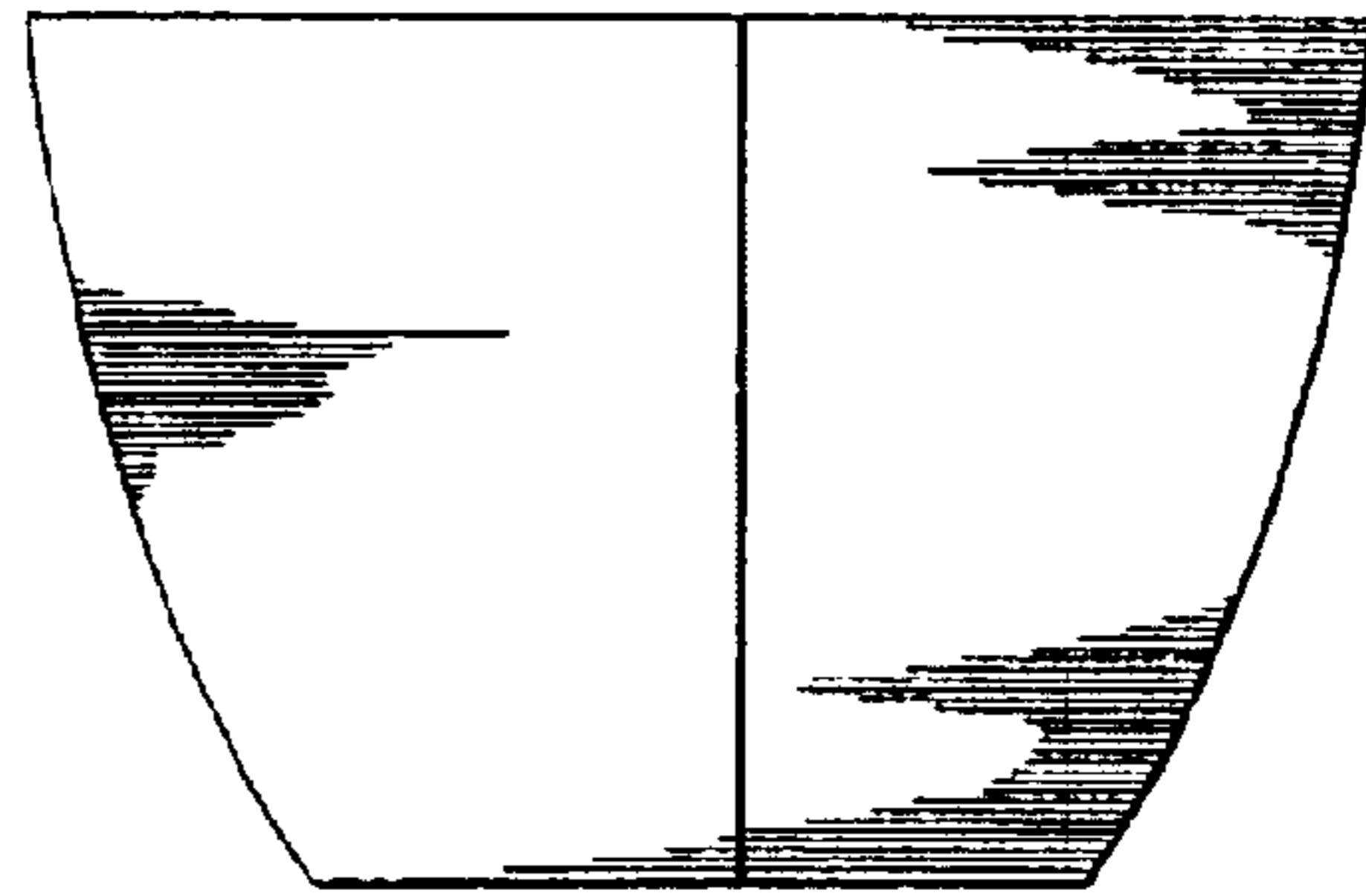

Fig. 4

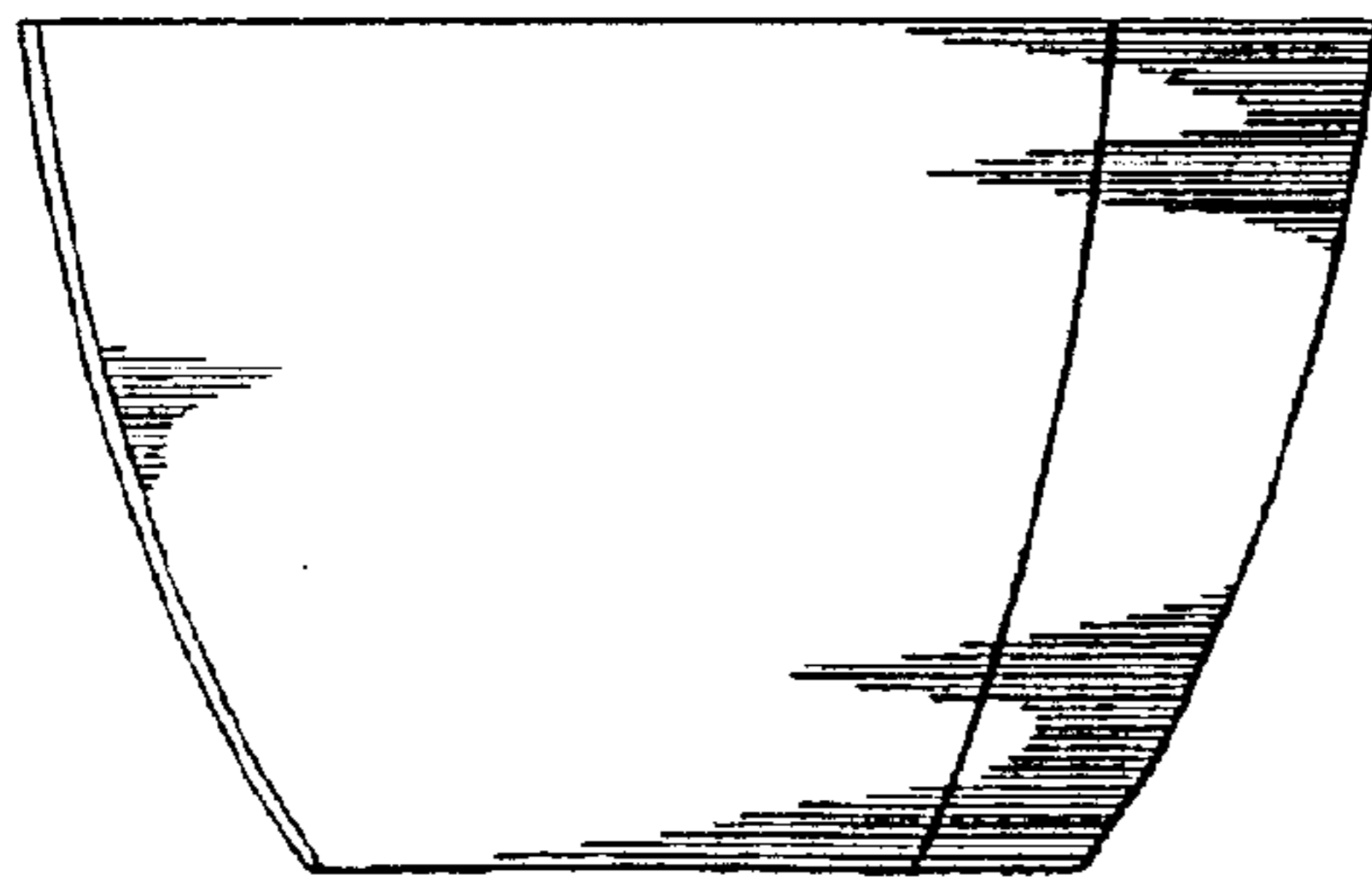

Fig. 5

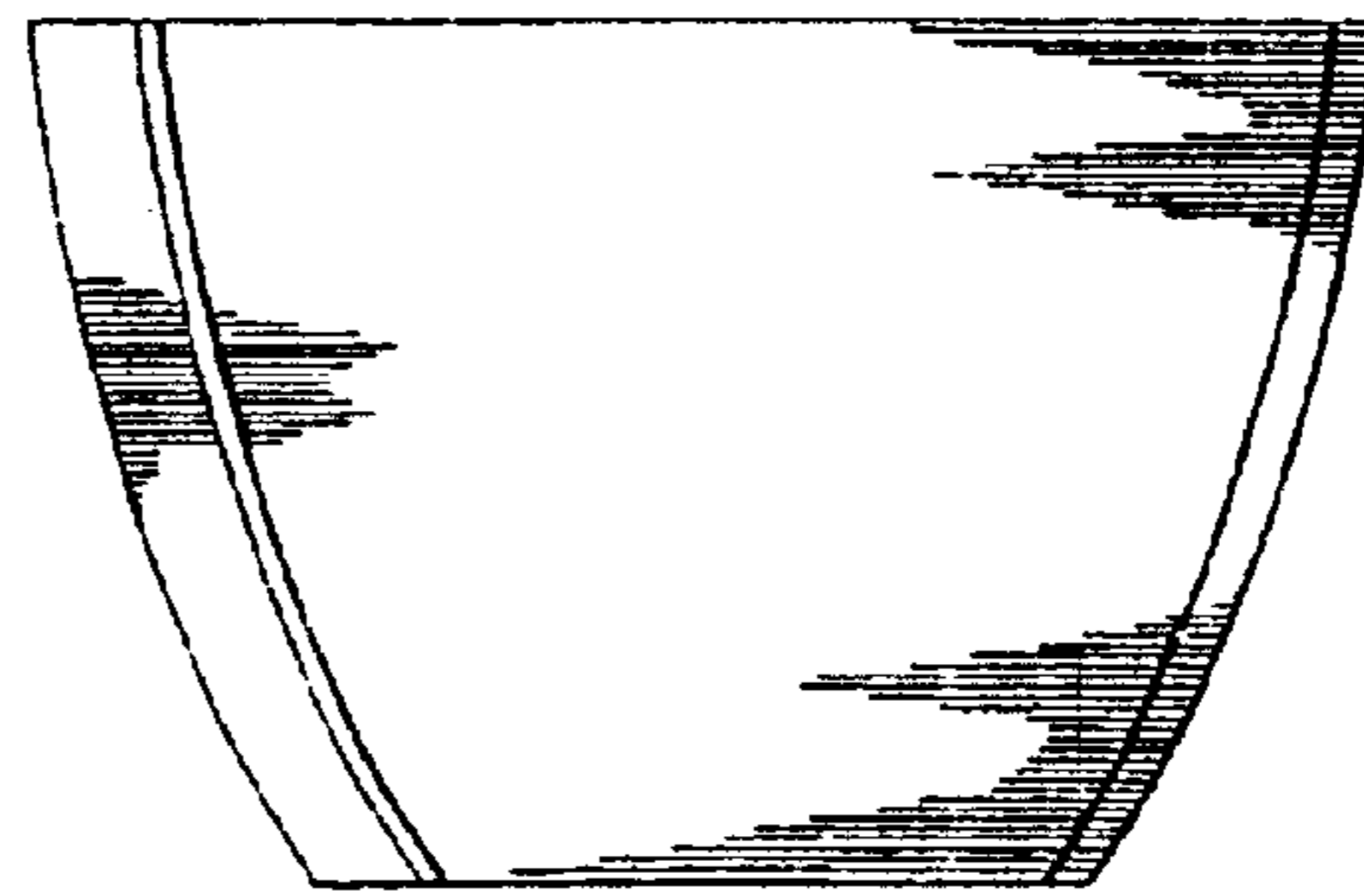

Fig. 6

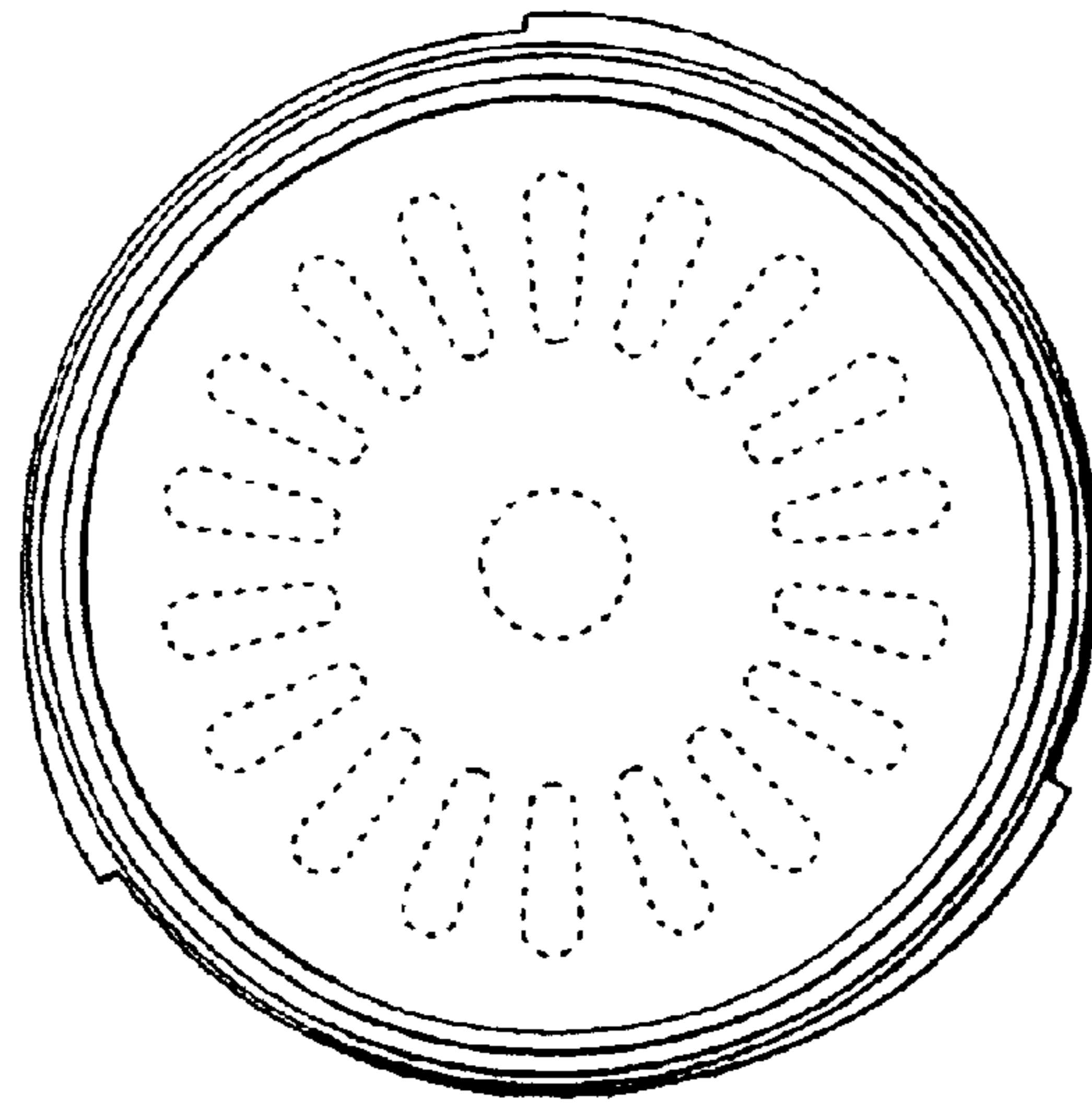

Fig. 7

