



US00D516186S

(12) **United States Design Patent**
Gilbert

(10) **Patent No.:** **US D516,186 S**

(45) **Date of Patent:** **** Feb. 28, 2006**

(54) **SPOUT**

(75) **Inventor:** **Christopher Jon Gilbert**, Moreland Hills, OH (US)

(73) **Assignee:** **Moen Incorporated**, North Olmsted, OH (US)

(**) **Term:** **14 Years**

(21) **Appl. No.:** **29/202,387**

(22) **Filed:** **Mar. 30, 2004**

(51) **LOC (8) Cl.** **23-01**

(52) **U.S. Cl.** **D23/255; D23/257**

(58) **Field of Classification Search** D23/238-257;
4/675-678; 137/801

See application file for complete search history.

(56) **References Cited**

U.S. PATENT DOCUMENTS

1,150,098 A	8/1915	Bunting	
1,548,570 A	8/1925	Wuesthoff	
1,790,316 A	1/1931	Mueller	
1,824,492 A	9/1931	Morris	
D181,595 S	* 12/1957	McLean D23/241
2,848,721 A	* 8/1958	Frederickson 4/676
D266,452 S	10/1982	Fleischmann et al.	
D365,143 S	12/1995	Fabian	
D442,265 S	5/2001	Marinov et al.	
D442,266 S	* 5/2001	Marinov et al. D23/257
D460,809 S	7/2002	Singtoroj	
D461,232 S	* 8/2002	Mullenmeister D23/257
D462,750 S	9/2002	Lord	

D463,014 S	9/2002	Lord	
D463,536 S	9/2002	Lord	
D467,321 S	12/2002	Otero et al.	
D477,059 S	* 7/2003	Schönherr et al. D23/255

* cited by examiner

Primary Examiner—Louis S. Zarfes

Assistant Examiner—Gregory Andoll

(74) *Attorney, Agent, or Firm*—Calfee, Halter & Griswold LLP

(57) **CLAIM**

The ornamental design for a spout, as shown and described.

DESCRIPTION

FIG. 1 is a perspective view of a spout of the new design; FIG. 2 is a front view of the spout of FIG. 1; FIG. 3 is a back view of the spout of FIG. 1; FIG. 4 is a top view of the spout of FIG. 1; FIG. 5 is a side view of the spout of FIG. 1; FIG. 6 is a bottom view of the spout of FIG. 1; FIG. 7 is a side view of the spout of FIG. 1; FIG. 8 is a perspective view of a second embodiment of the spout of the new design; FIG. 9 is a front view of the spout of FIG. 8; FIG. 10 is a back view of the spout of FIG. 8; FIG. 11 is a top view of the spout of FIG. 8; FIG. 12 is a side view of the spout of FIG. 8; FIG. 13 is a bottom view of the spout of FIG. 8; and, FIG. 14 is a side view of the spout of FIG. 8.

The portions of the Figures shown in phantom lines are not part of the claimed design but are for illustration only.

1 Claim, 6 Drawing Sheets

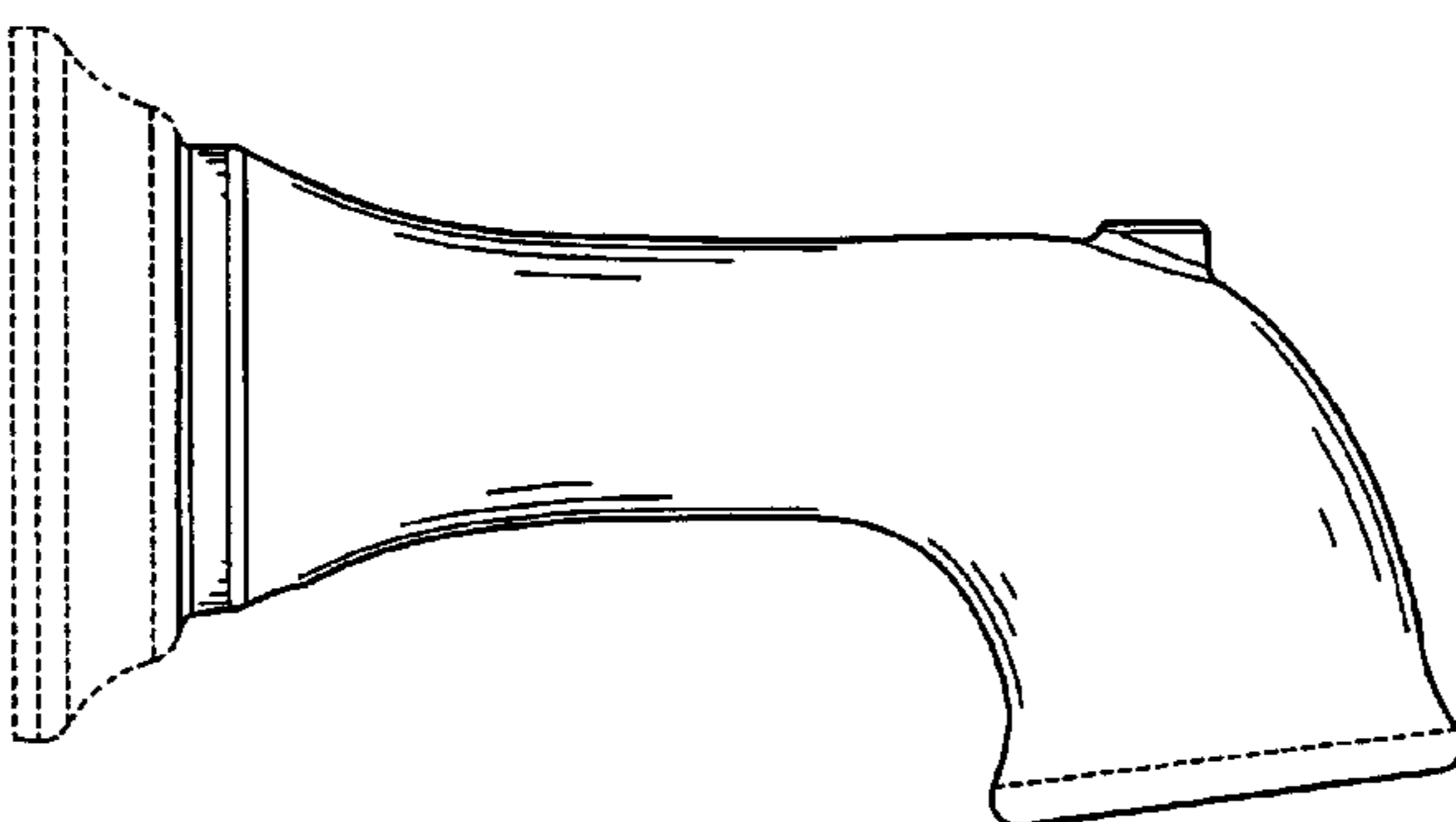
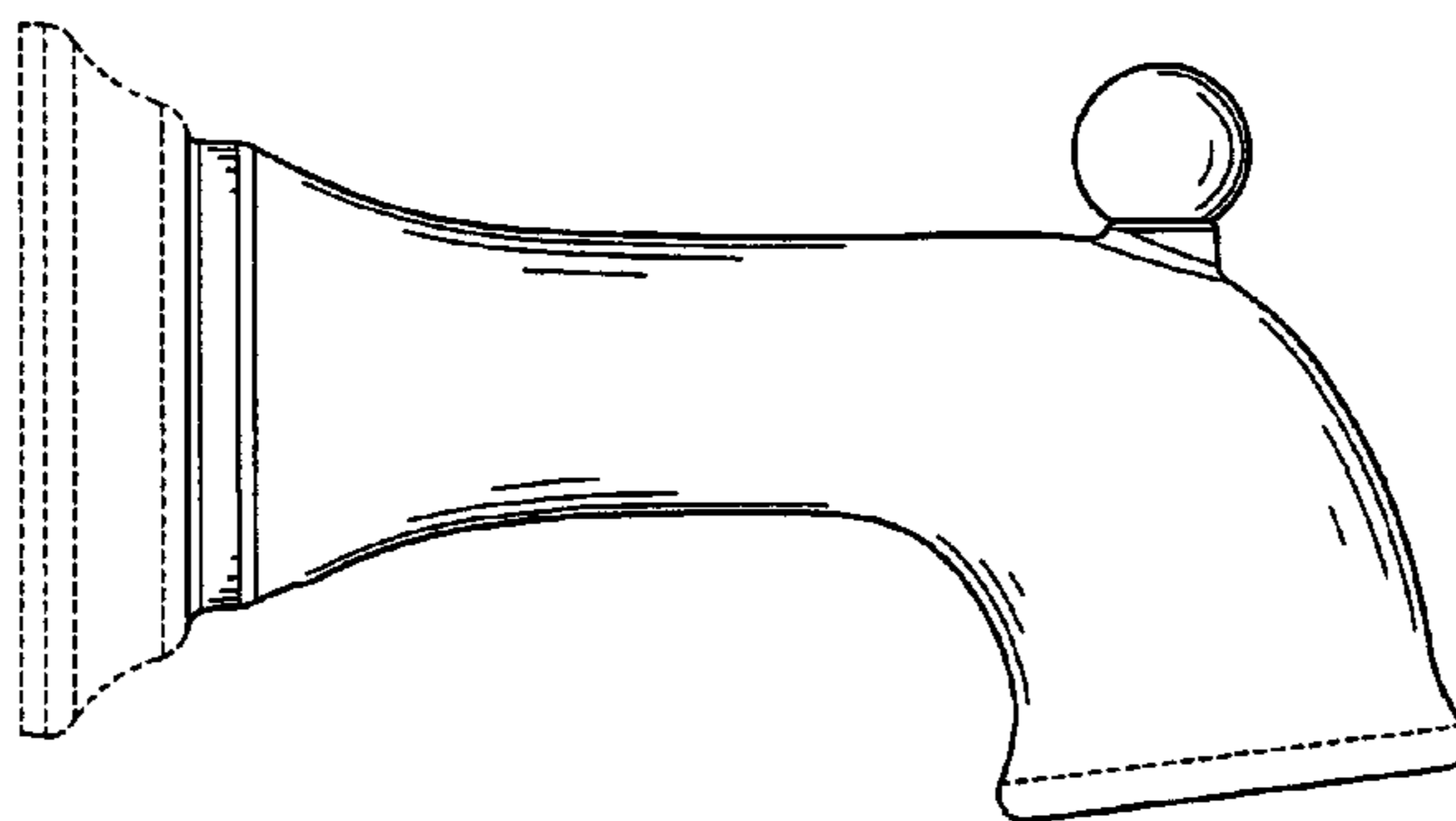

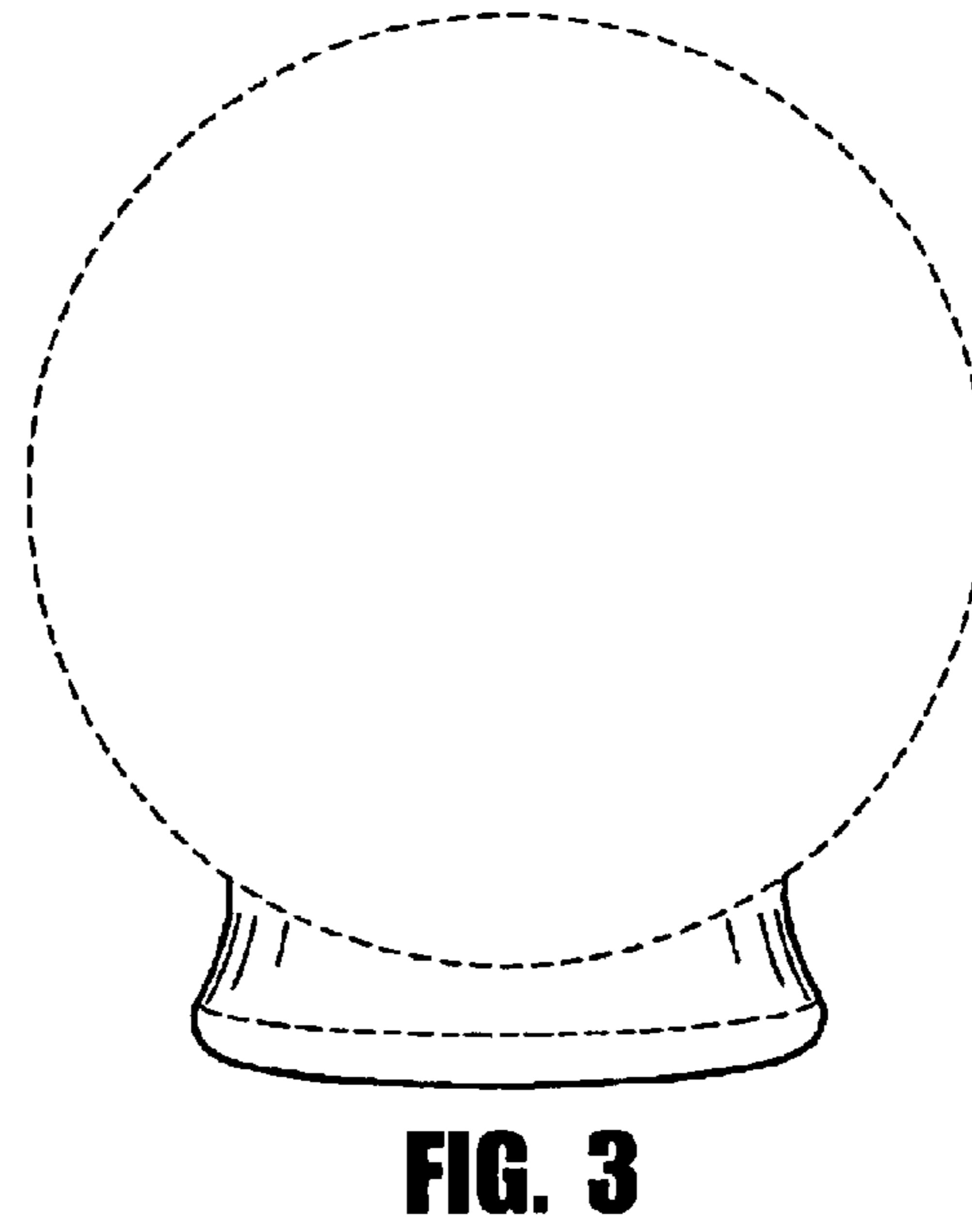
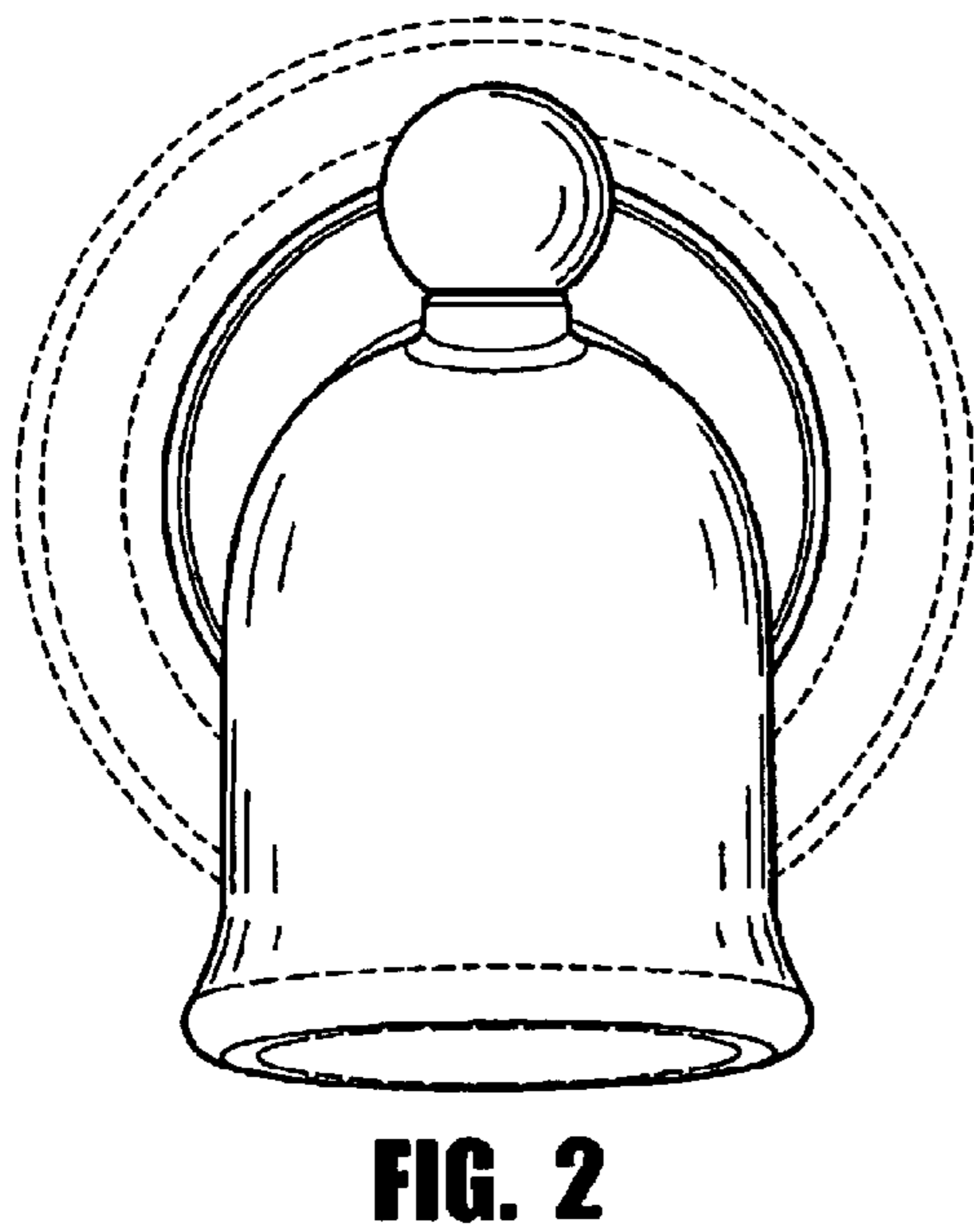
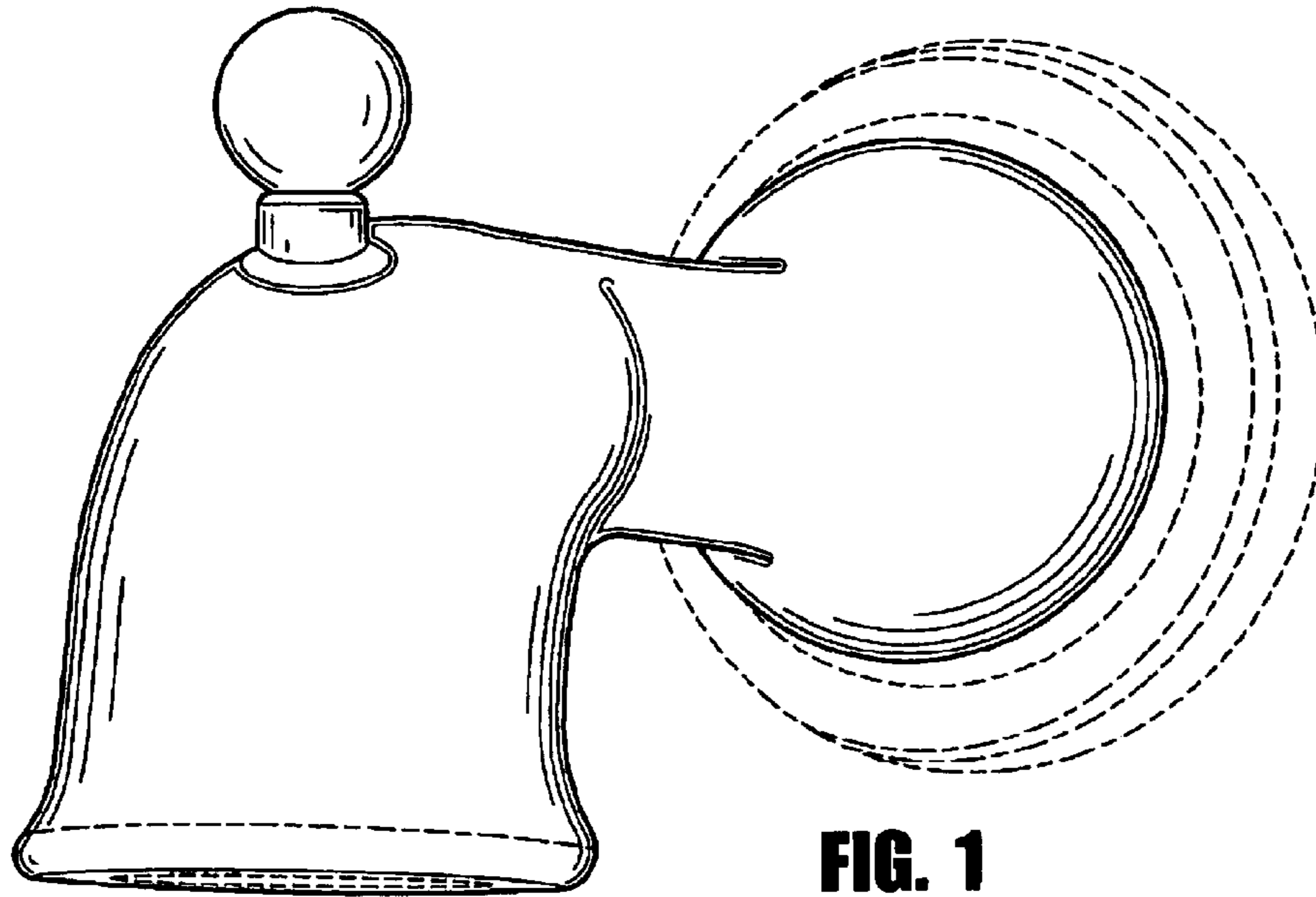

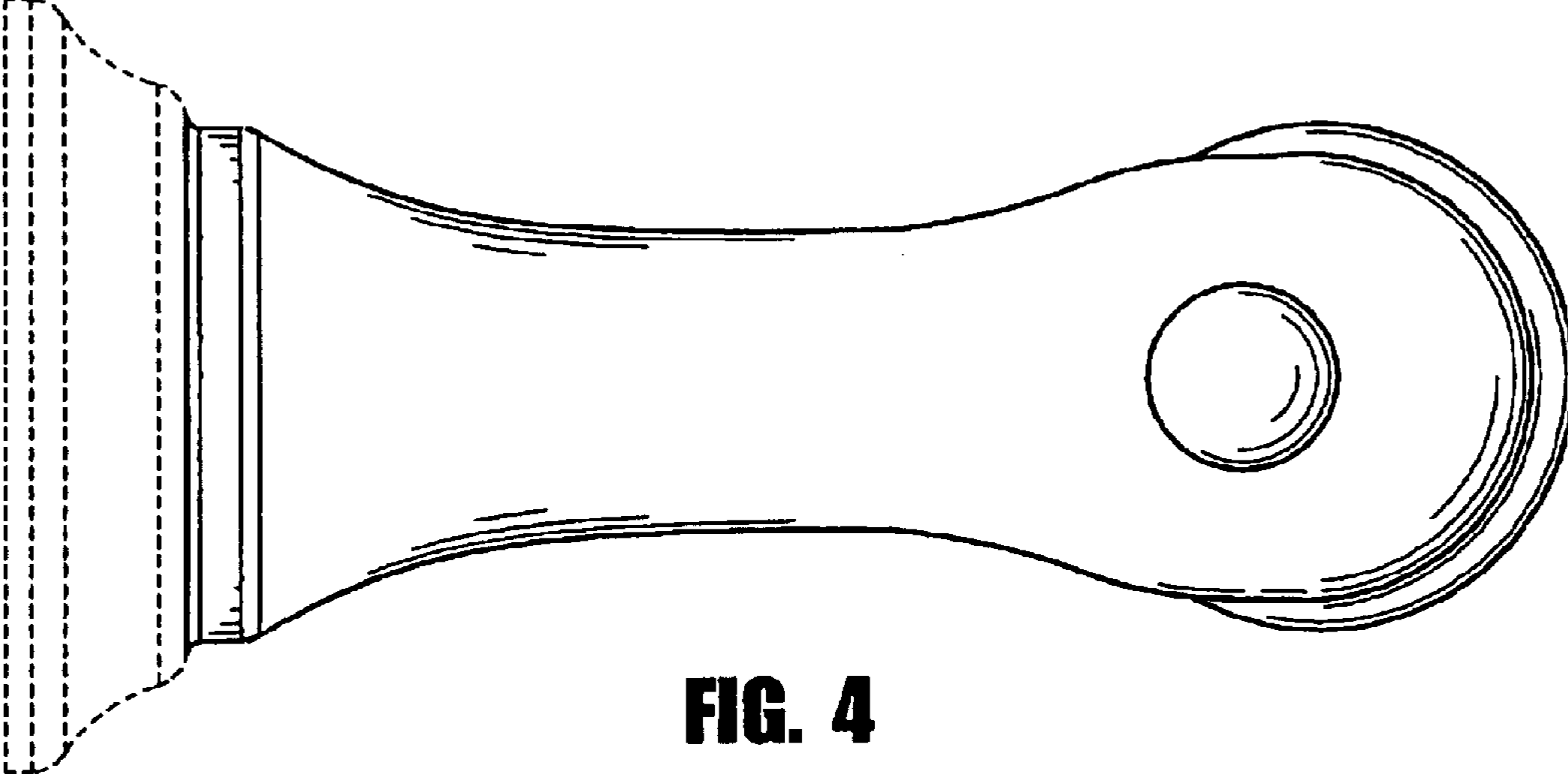

FIG. 4

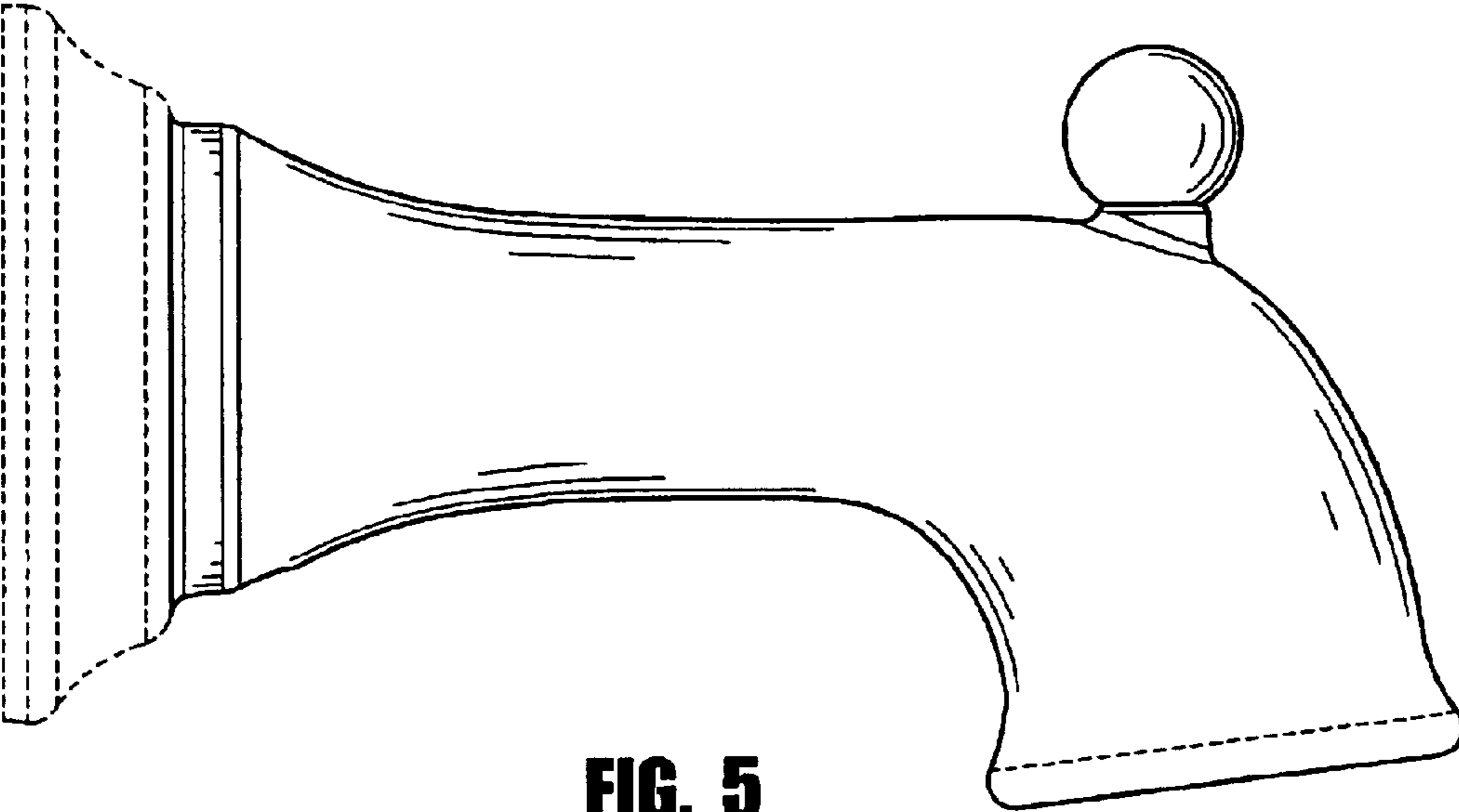

FIG. 5

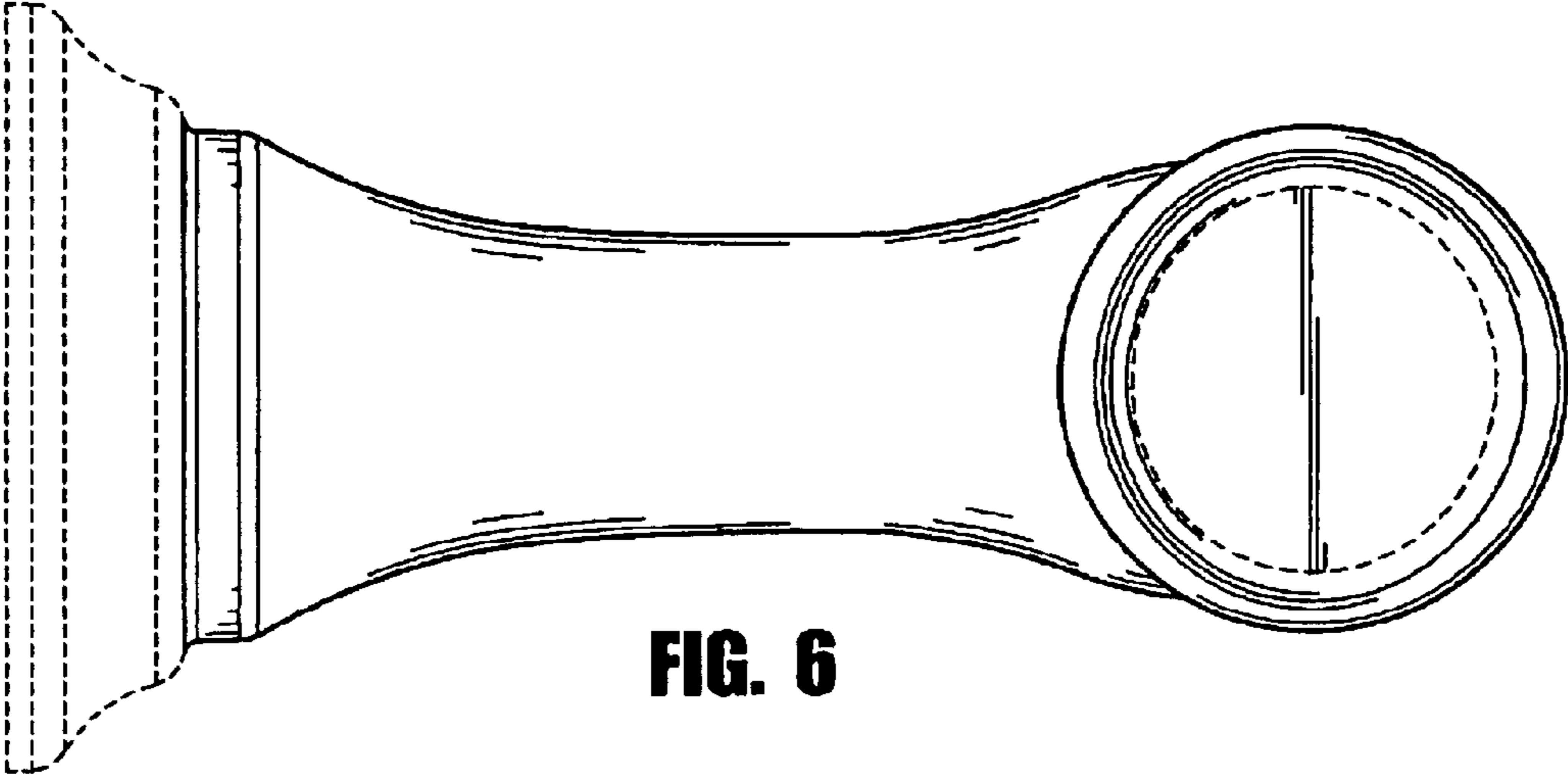

FIG. 6

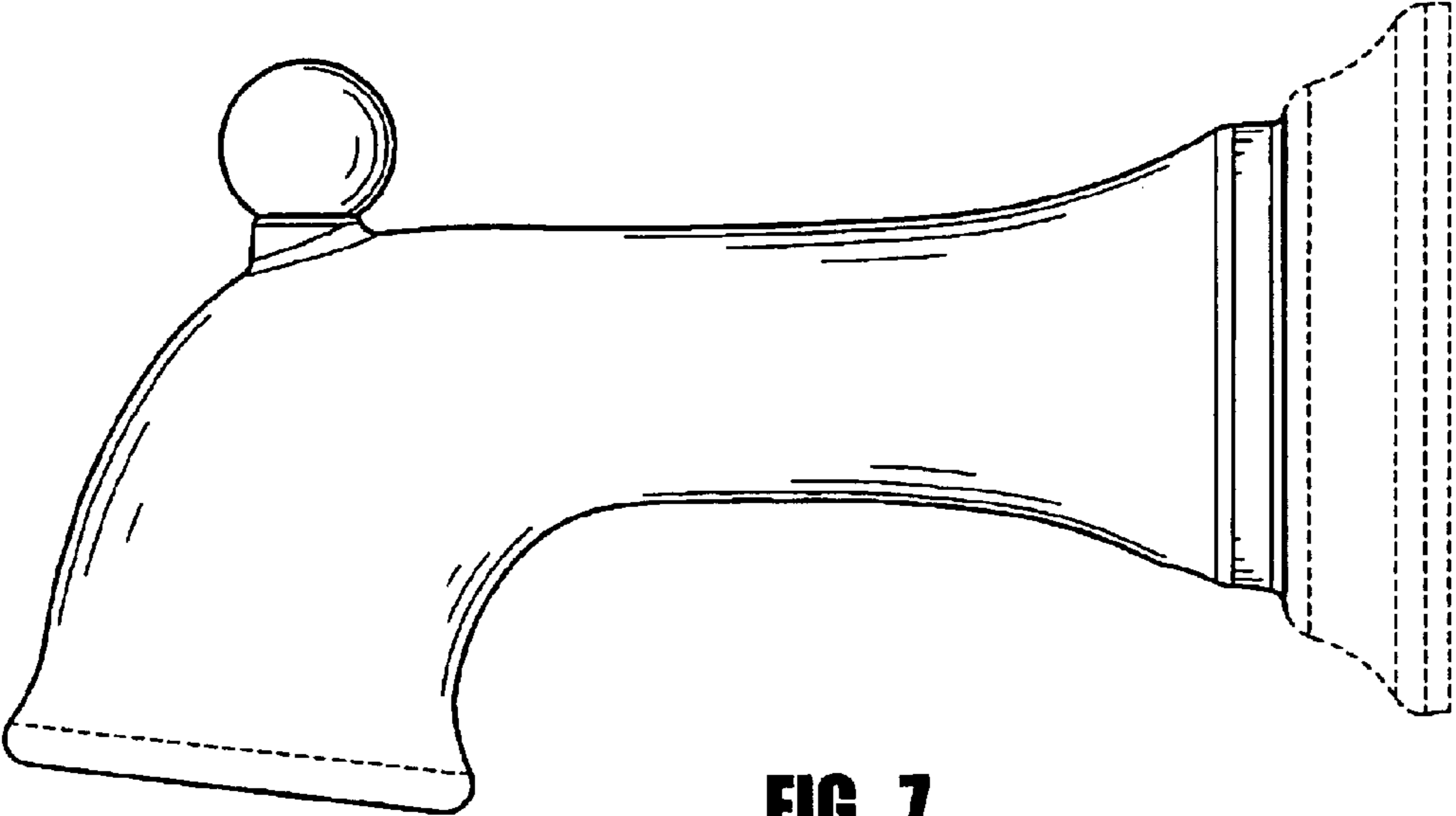

FIG. 7

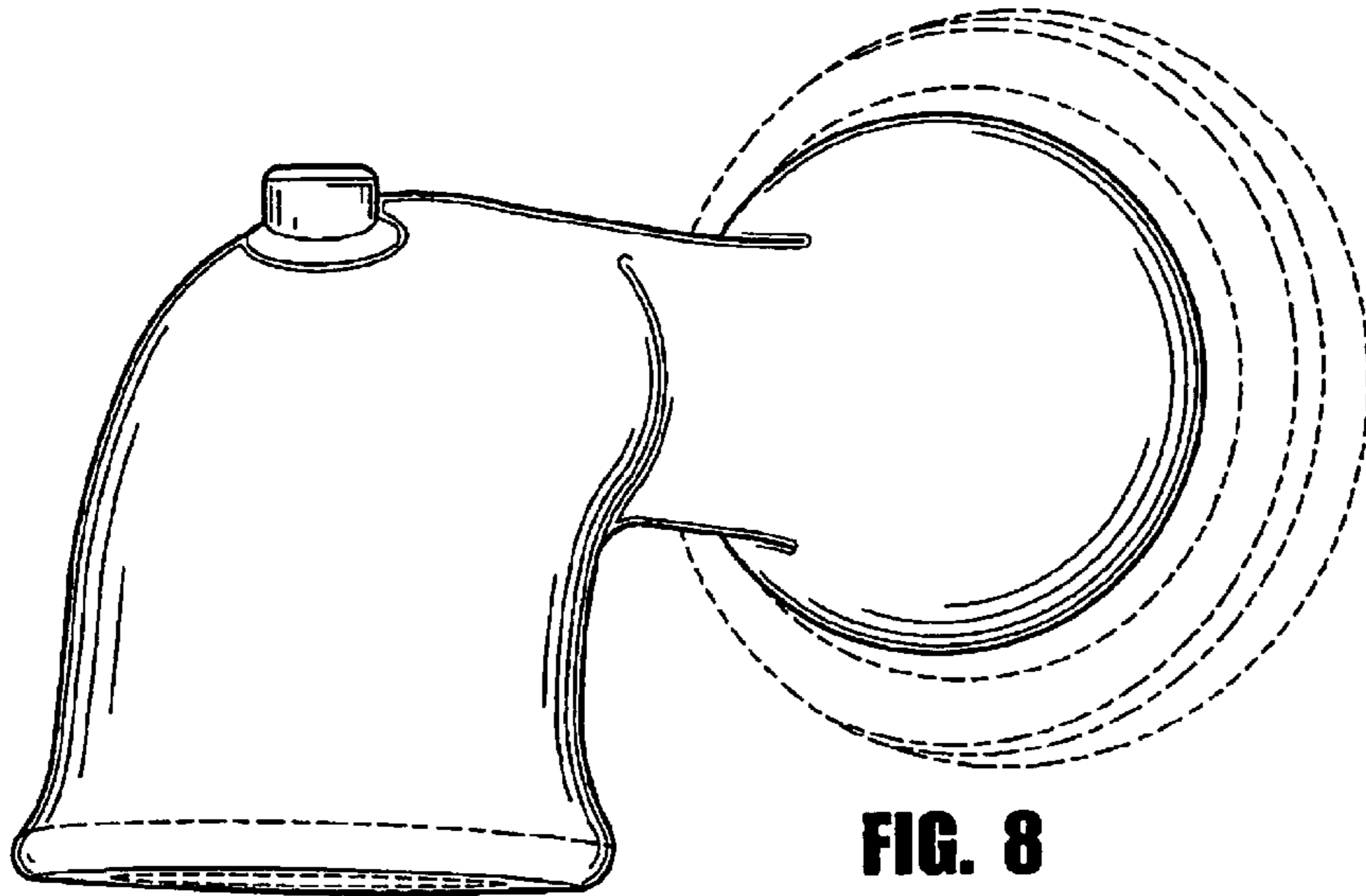

FIG. 8

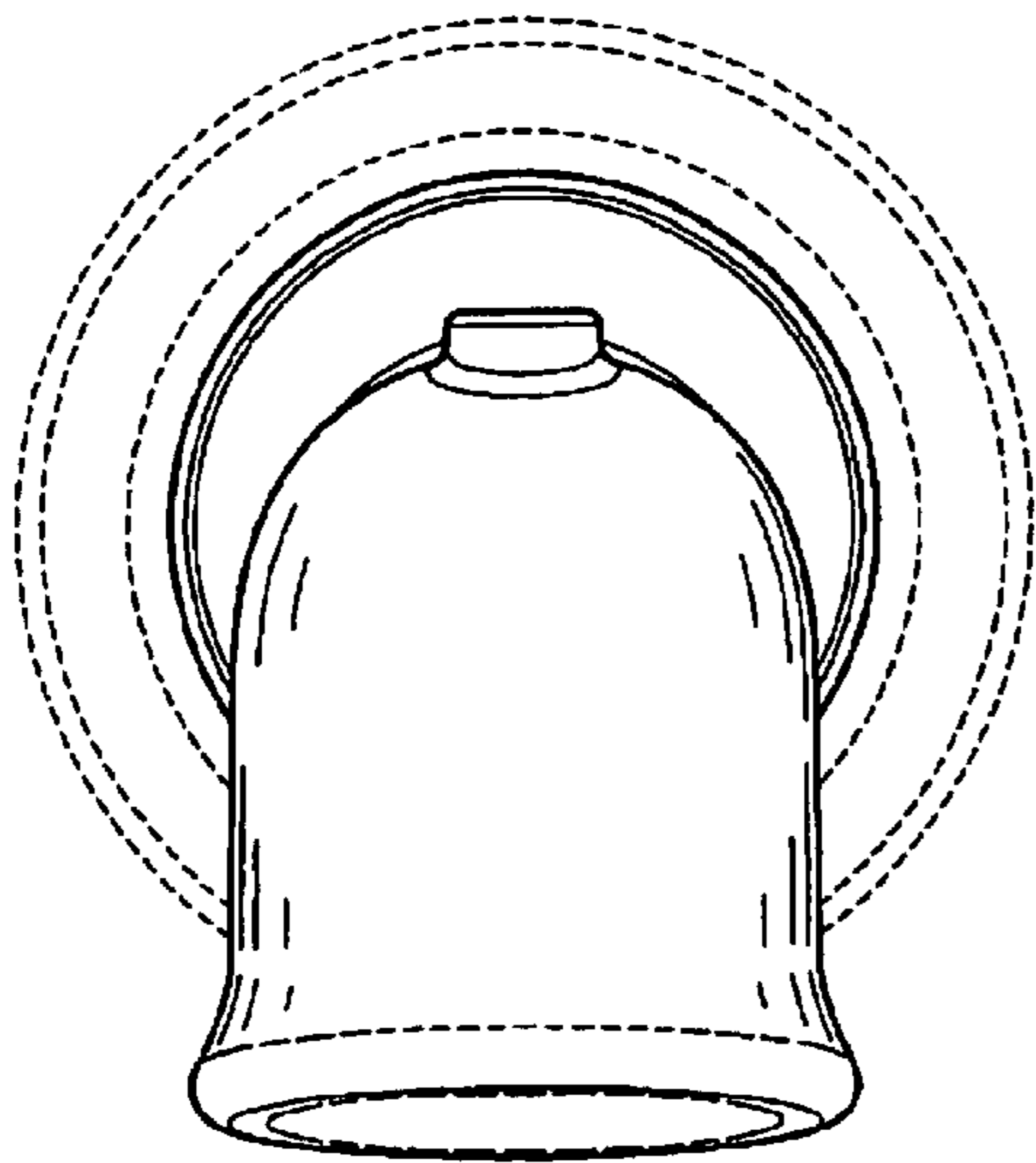

FIG. 9

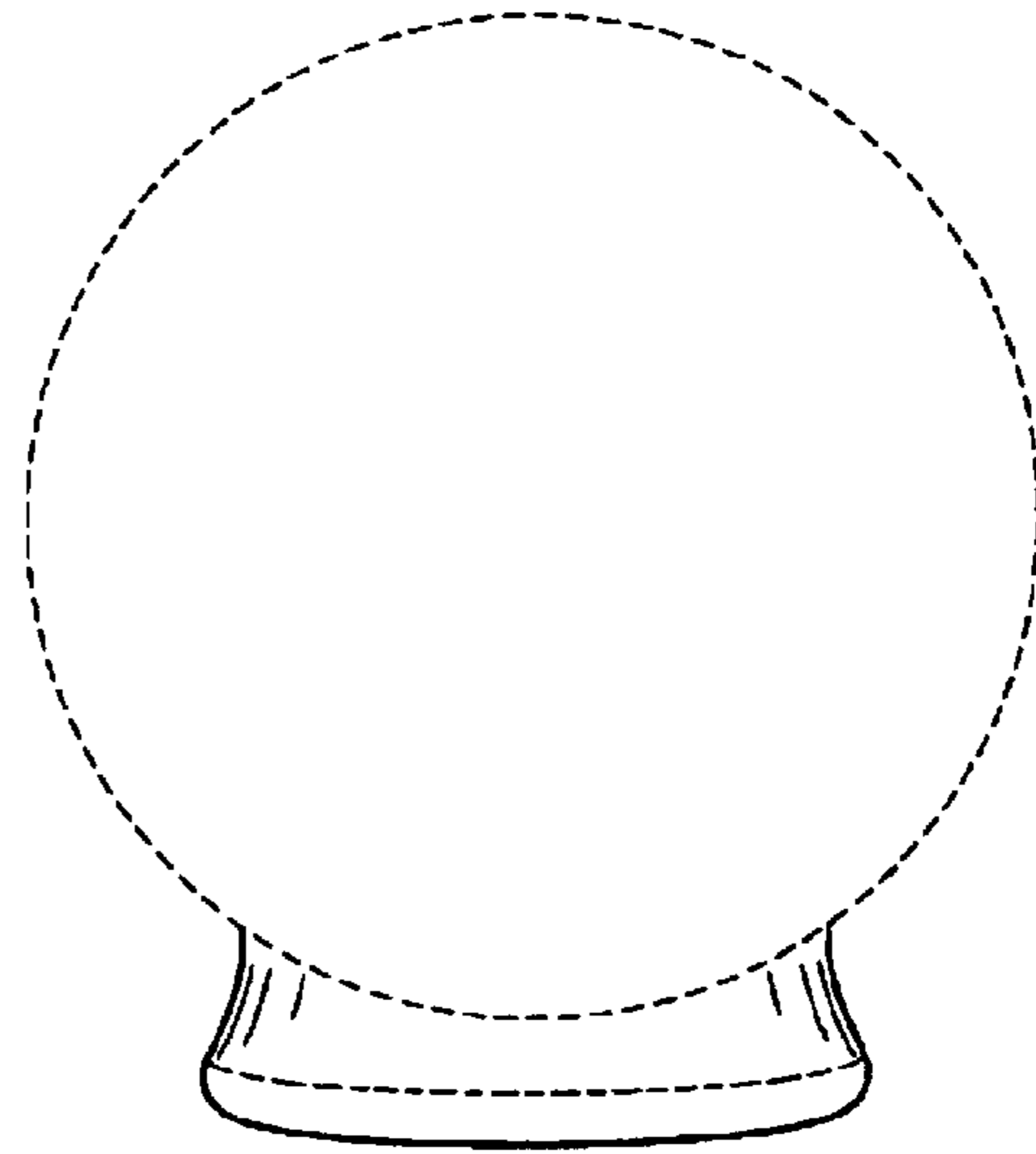

FIG. 10

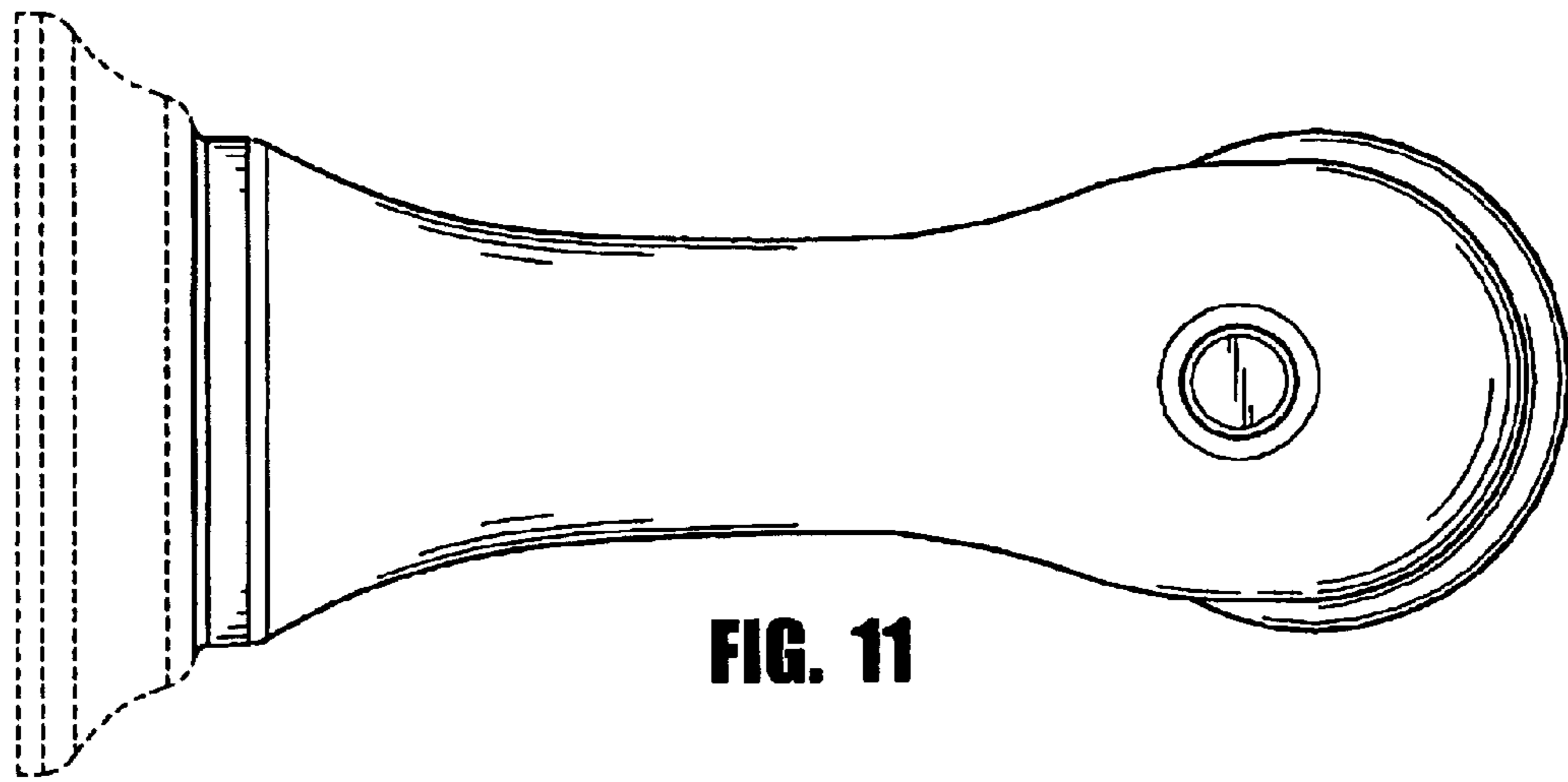

FIG. 11

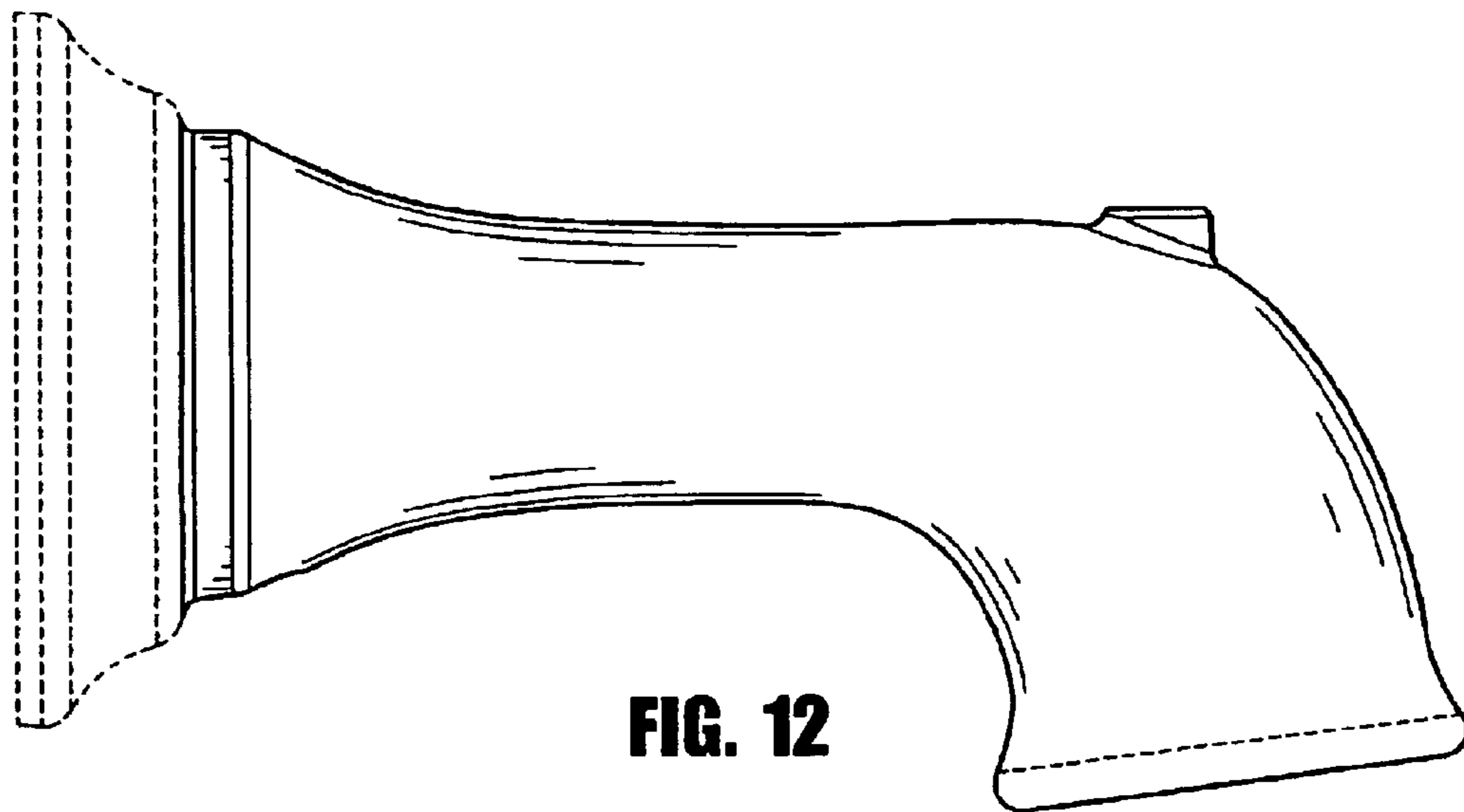

FIG. 12

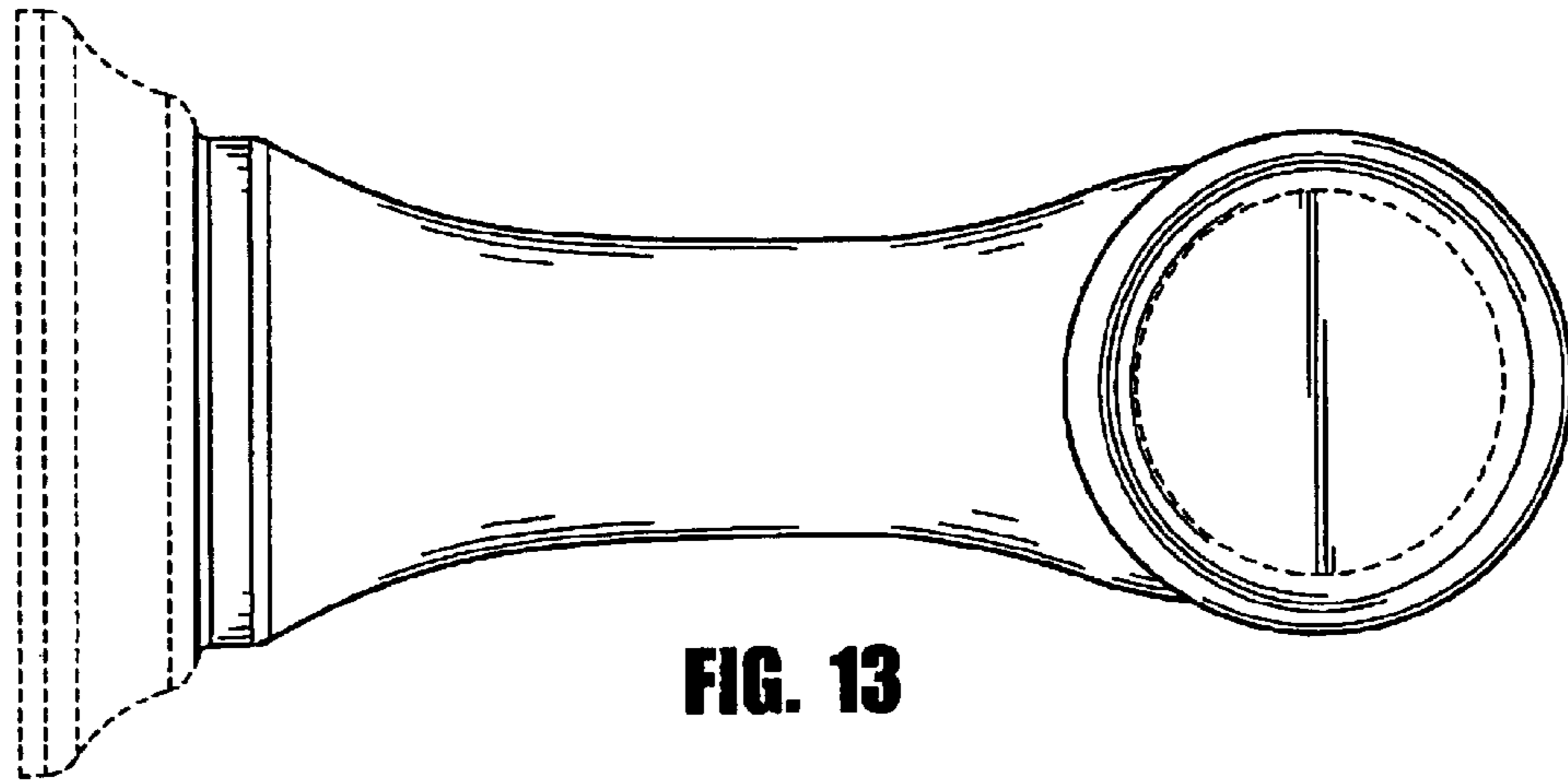

FIG. 13

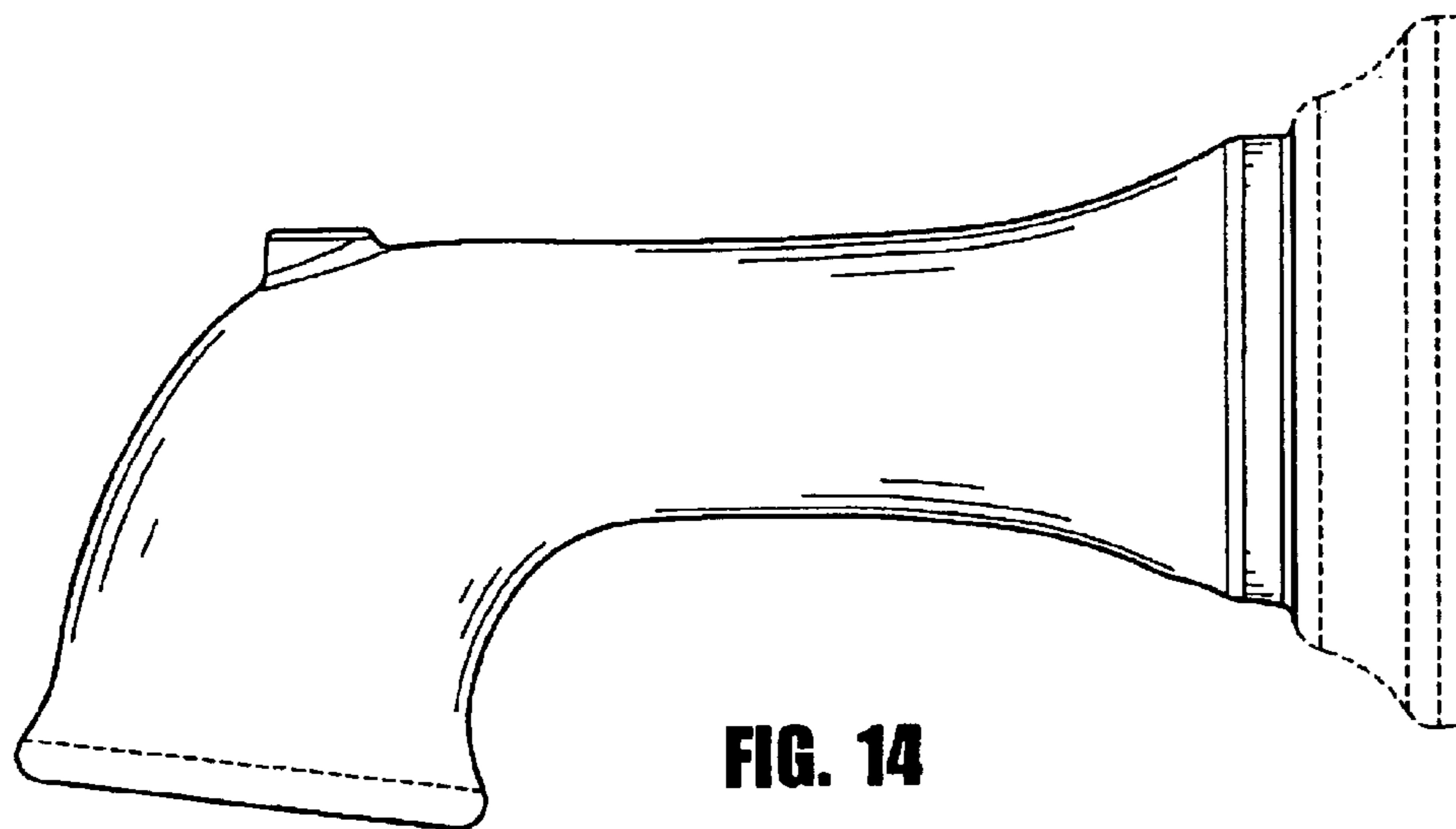

FIG. 14