



US00D516147S

(12) **United States Design Patent**
Imamoto

(10) **Patent No.:** **US D516,147 S**
(45) **Date of Patent:** **** Feb. 28, 2006**

(54) **GOLF CLUB HEAD**

(75) Inventor: **Yasunori Imamoto**, Kawasaki (JP)

(73) Assignee: **Bridgestone Sports Co. Ltd.**, Tokyo (JP)

(**) Term: **14 Years**

(21) Appl. No.: **29/208,985**

(22) Filed: **Jul. 9, 2004**

(30) **Foreign Application Priority Data**

Jan. 12, 2004 (KR) 30-2004-0000717

(51) **LOC (8) Cl.** **21-02**

(52) **U.S. Cl.** **D21/733**

(58) **Field of Classification Search** D21/733,
D21/752, 759; 473/324–331, 343–346
See application file for complete search history.

(56) **References Cited**

U.S. PATENT DOCUMENTS

D363,517 S	*	10/1995	Lin	D21/752
D400,627 S	*	11/1998	Kubica et al.	D21/733
D414,831 S	*	10/1999	Matsuo	D21/752
D437,903 S		2/2001	Cope	D21/752
D445,863 S		7/2001	Galloway et al.	D21/752
D490,488 S	*	5/2004	Hoffmann et al.	D21/752
D498,508 S	*	11/2004	Antonious	D21/752
D501,235 S	*	1/2005	Imamoto	D21/752
D502,232 S	*	2/2005	Antonious	D21/733

FOREIGN PATENT DOCUMENTS

JP	1088387	10/2000
JP	1140034	4/2002

* cited by examiner

Primary Examiner—Mitchell Siegel

(74) *Attorney, Agent, or Firm*—Morgan, Lewis & Bockius LLP

(57) **CLAIM**

The ornamental design for a golf club head, as shown.

DESCRIPTION

FIG. 1 is a perspective view of a first embodiment of a golf club head in accordance with my new design.

FIG. 2 is a front view of the first embodiment of the golf club head shown in FIG. 1.

FIG. 3 is a rear view of the first embodiment of the golf club head shown in FIG. 1.

FIG. 4 is a top view of the first embodiment of the golf club head shown in FIG. 1.

FIG. 5 is a bottom view of the first embodiment of the golf club head shown in FIG. 1.

FIG. 6 is a left-side view of the first embodiment of the golf club head shown in FIG. 1.

FIG. 7 is a right-side view of the first embodiment of the golf club head shown in FIG. 1.

FIG. 8 is a perspective view of a second embodiment of a golf club head in accordance with my new design.

FIG. 9 is a front view of the second embodiment of the golf club head shown in FIG. 8.

FIG. 10 is a rear view of the second embodiment of the golf club head shown in FIG. 8.

FIG. 11 is a top view of the second embodiment of the golf club head shown in FIG. 8.

FIG. 12 is a bottom view of the second embodiment of the golf club head shown in FIG. 8.

FIG. 13 is a right-side view of the second embodiment of the golf club head shown in FIG. 8.

FIG. 14 is a left-side view of the second embodiment of the golf club head shown in FIG. 8.

FIG. 15 is a perspective view of a third embodiment of a golf club head in accordance with my new design.

FIG. 16 is a front view of the third embodiment of the golf club head shown in FIG. 15.

FIG. 17 is a rear view of the third embodiment of the golf club head shown in FIG. 15.

FIG. 18 is a top view of the third embodiment of the golf club head shown in FIG. 15.

FIG. 19 is a bottom view of the third embodiment of the golf club head shown in FIG. 15.

FIG. 20 is a right-side view of the third embodiment of the golf club head shown in FIG. 15; and,

FIG. 21 is a left-side view of the third embodiment of the golf club head shown in FIG. 15.

The broken line showing is for illustrative purposes only and forms no part of the claimed design.

1 Claim, 9 Drawing Sheets

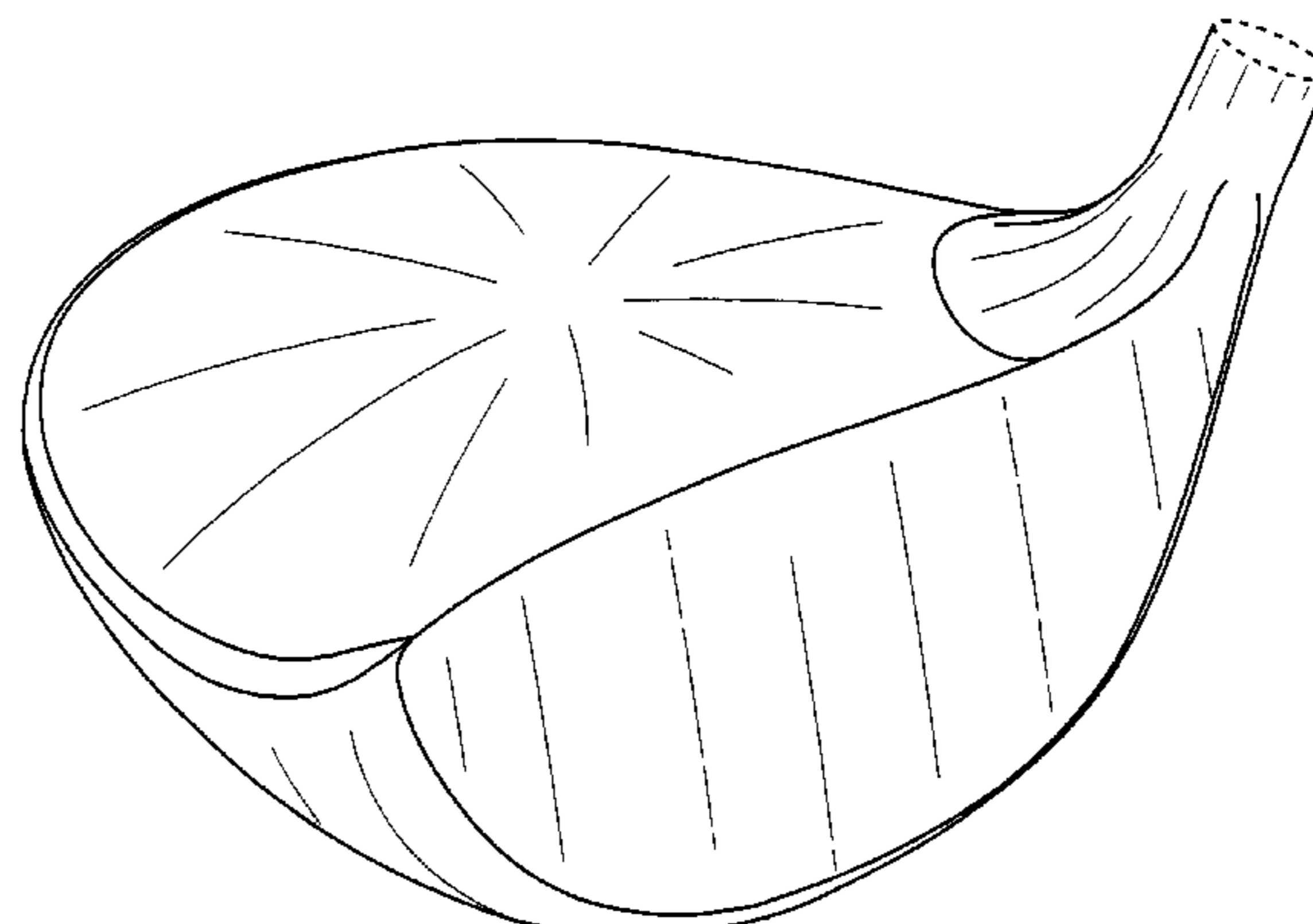

FIG. 1

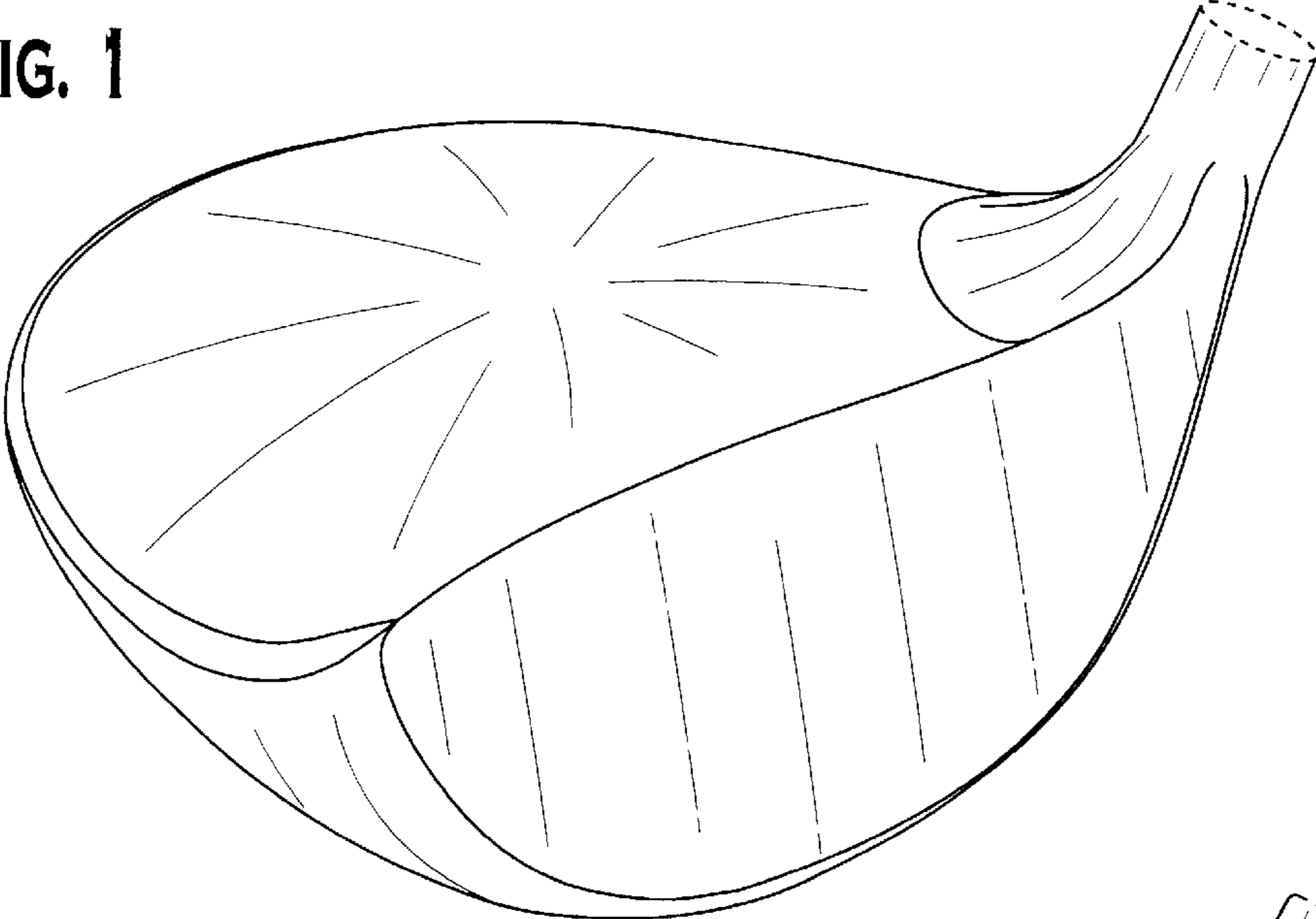

FIG. 2

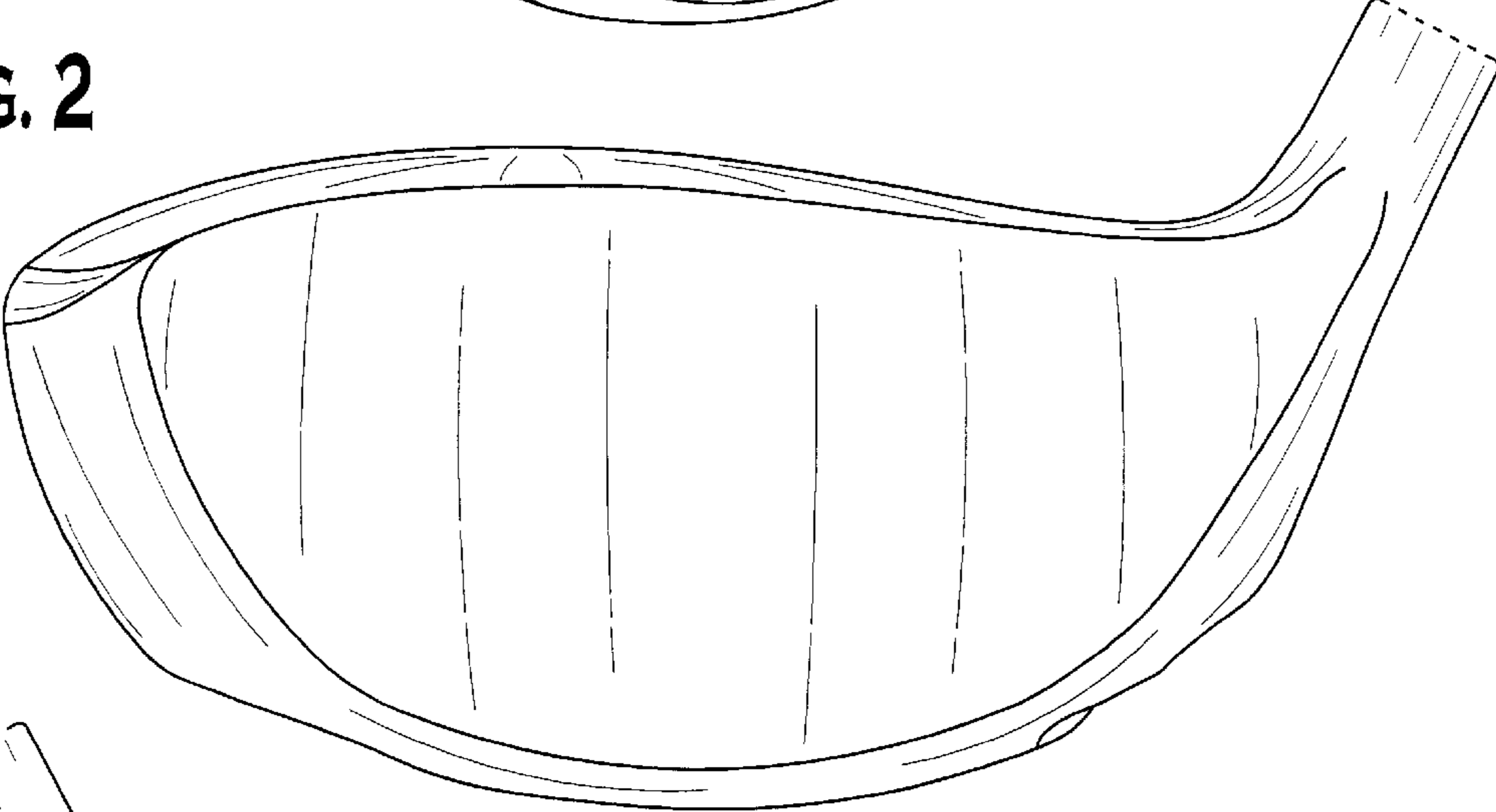

FIG. 3

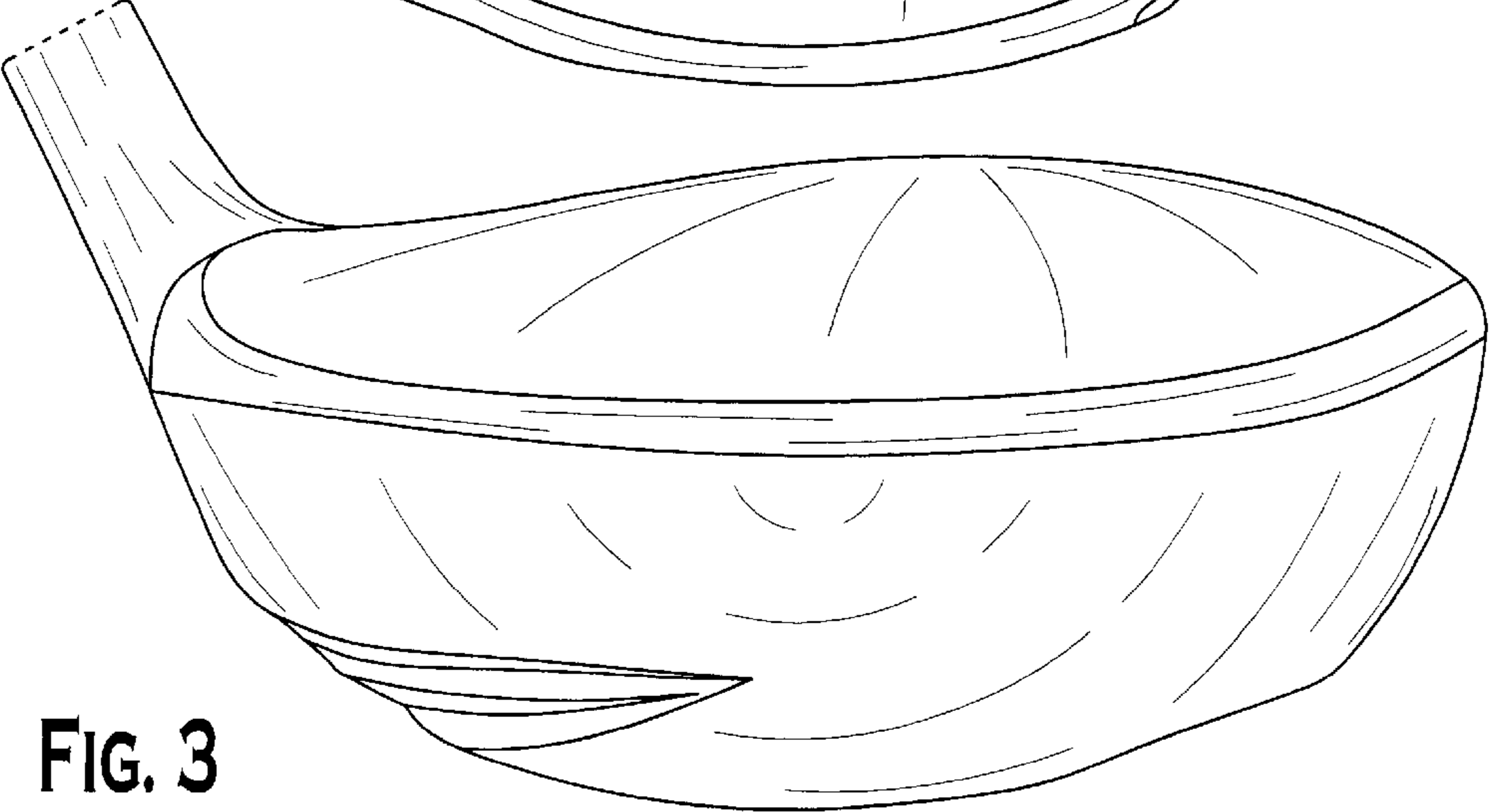

FIG. 4

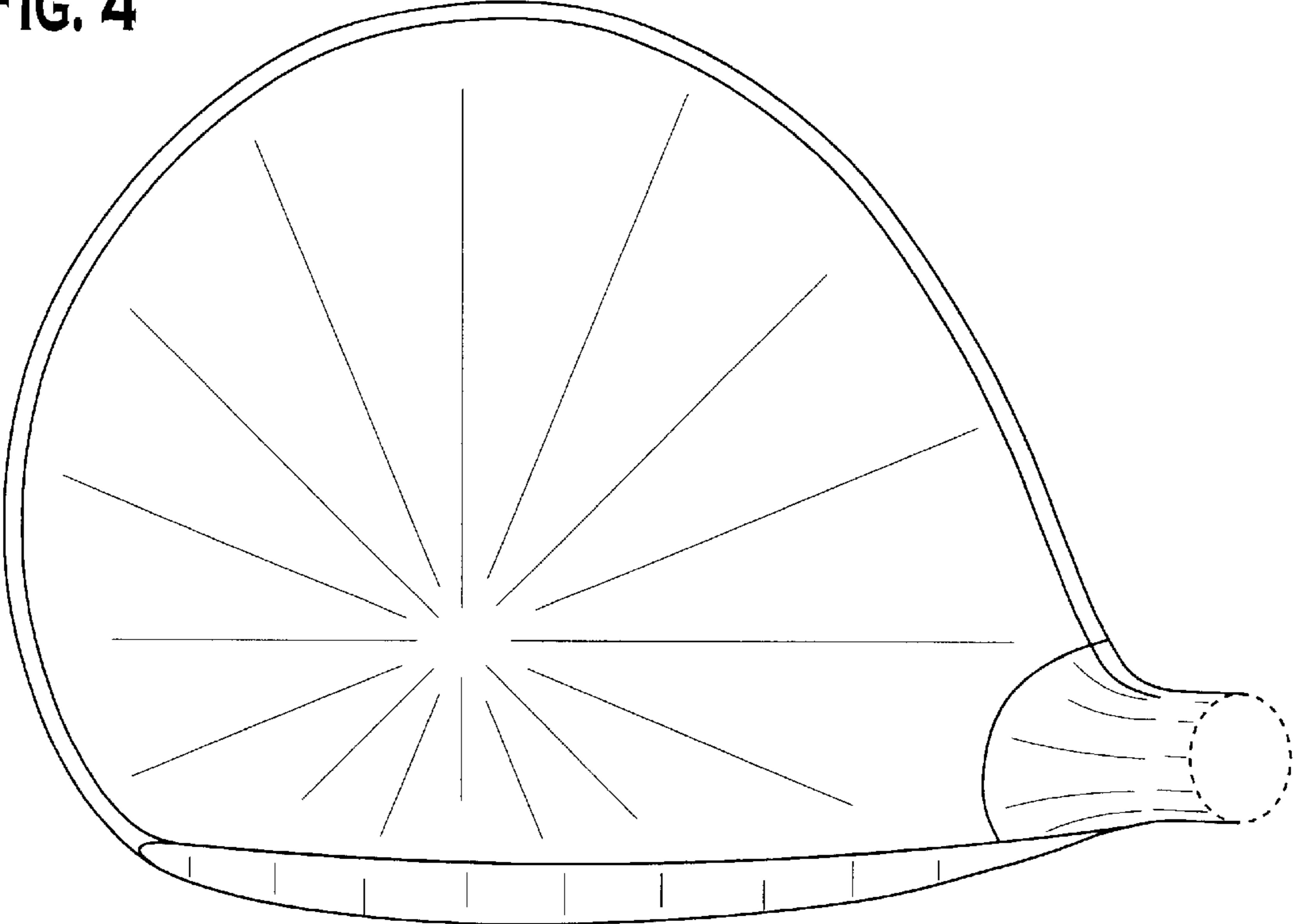

FIG. 5

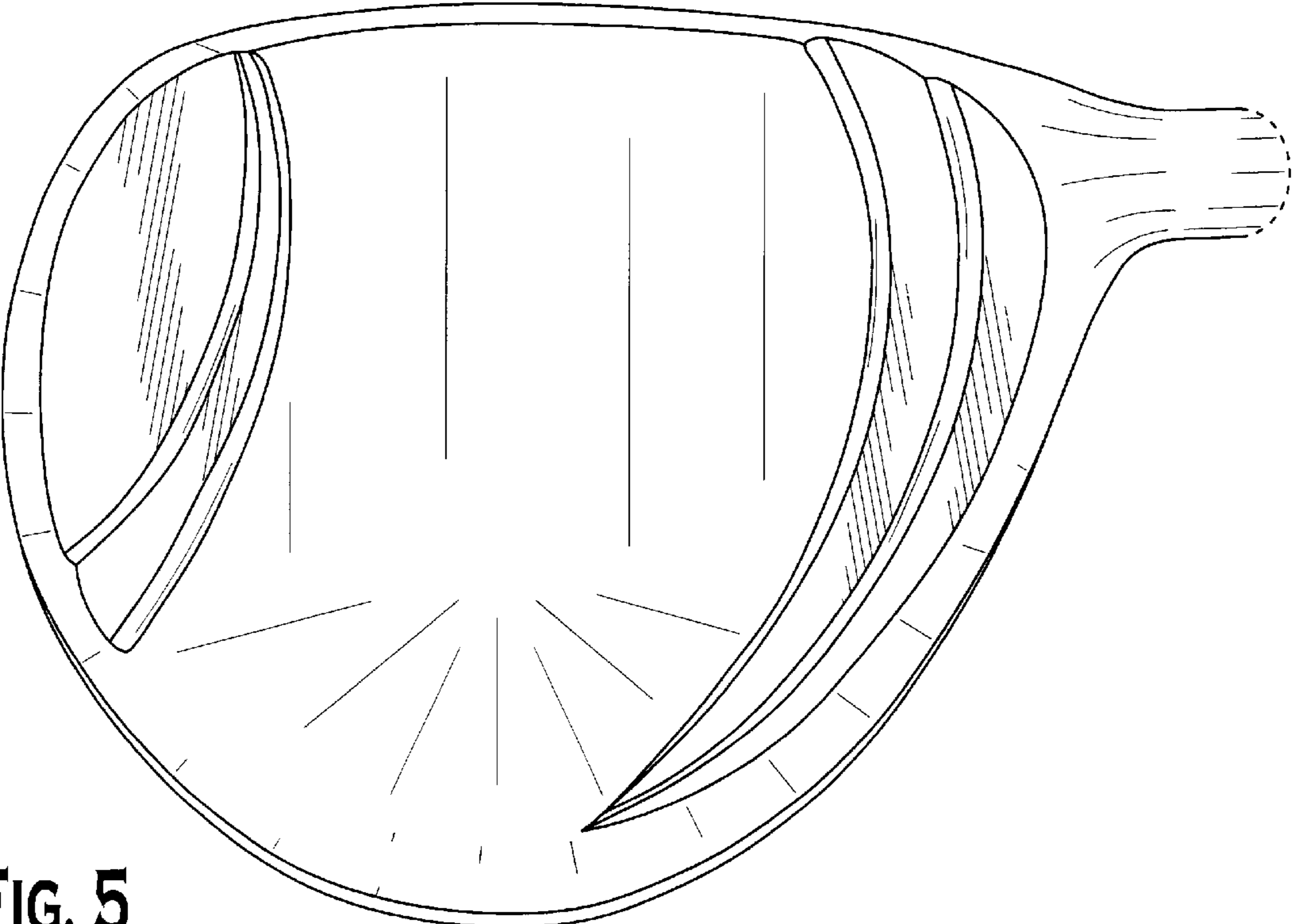

FIG. 6

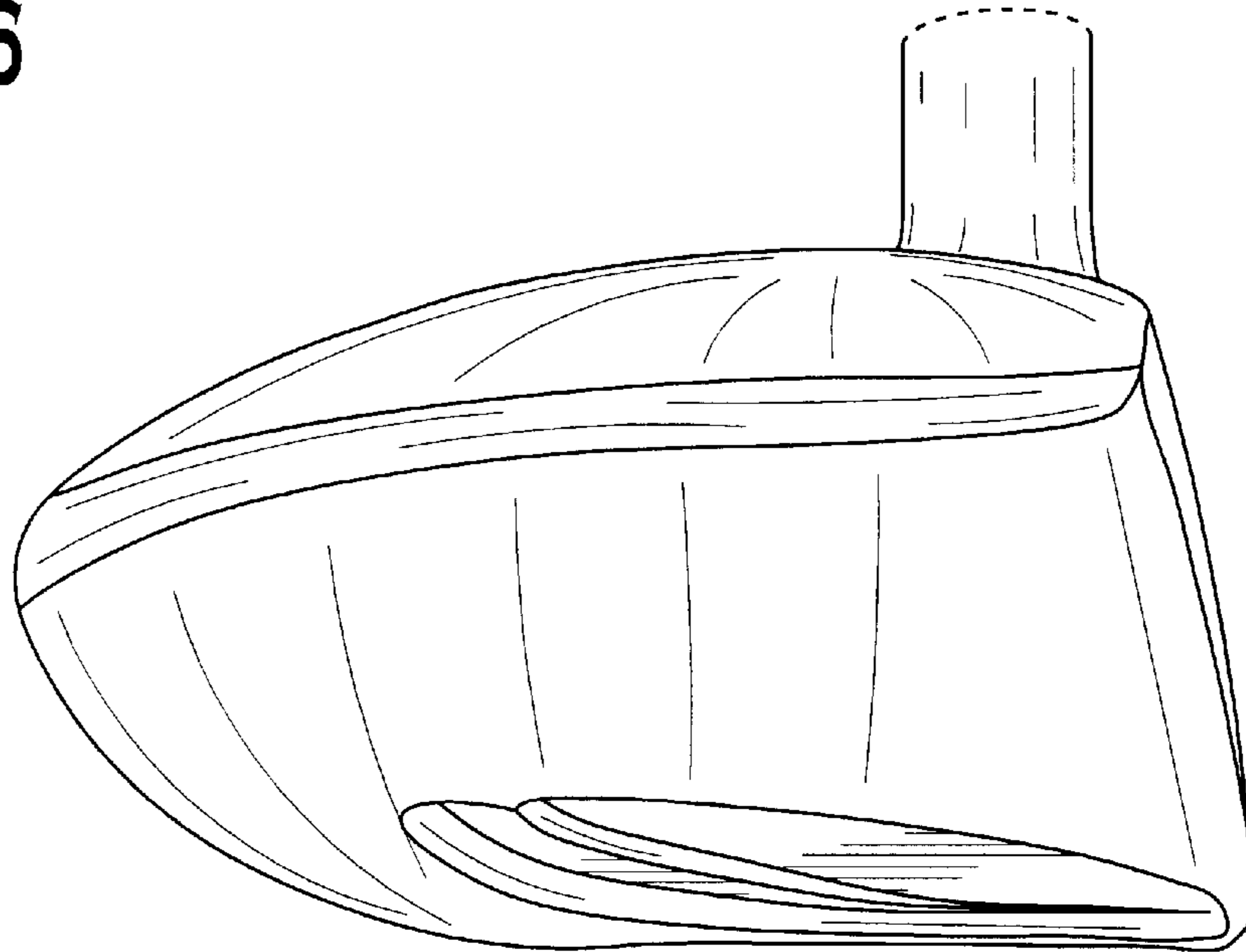

FIG. 7

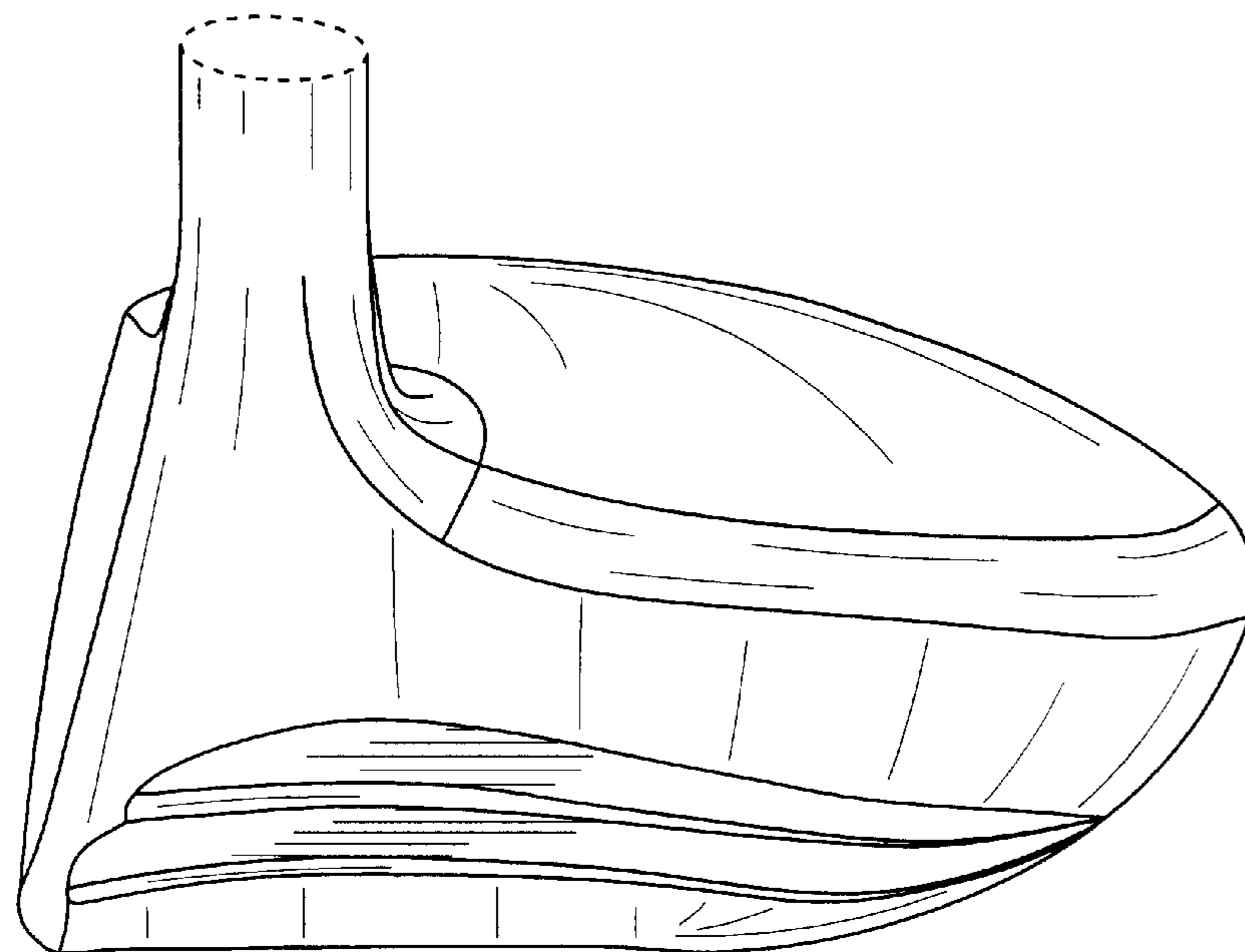

FIG. 8

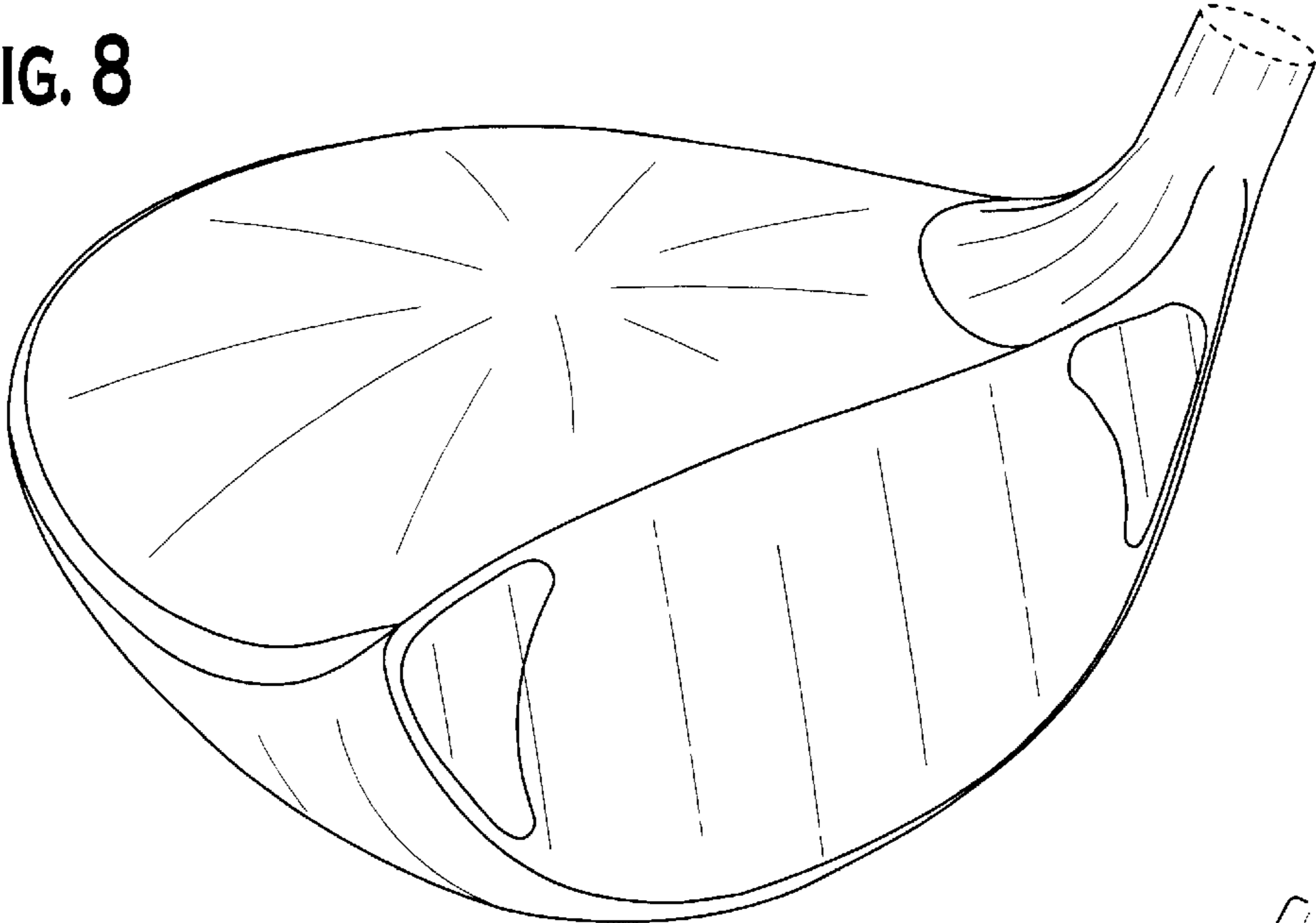

FIG. 9

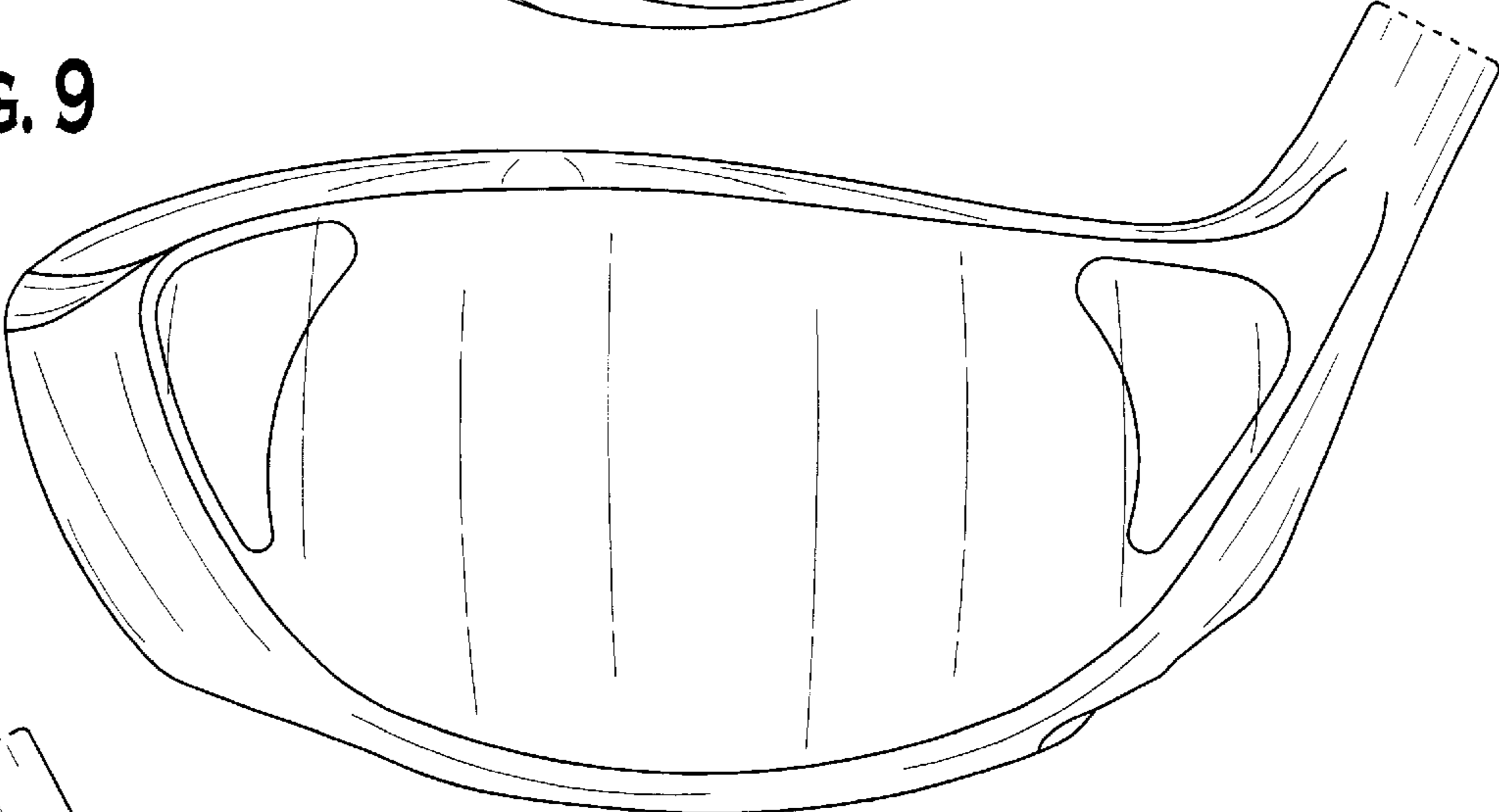

FIG. 10

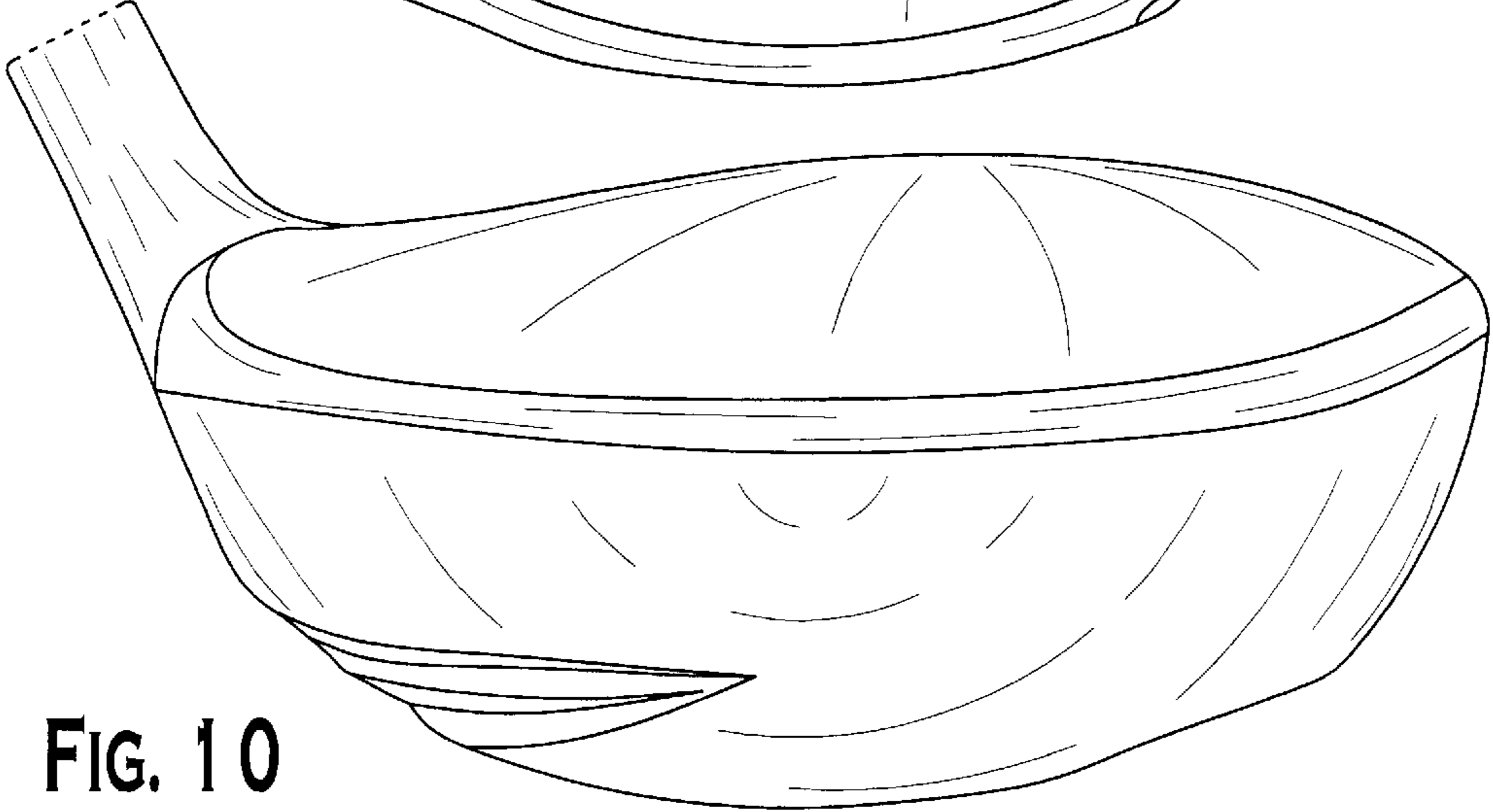

FIG. 11

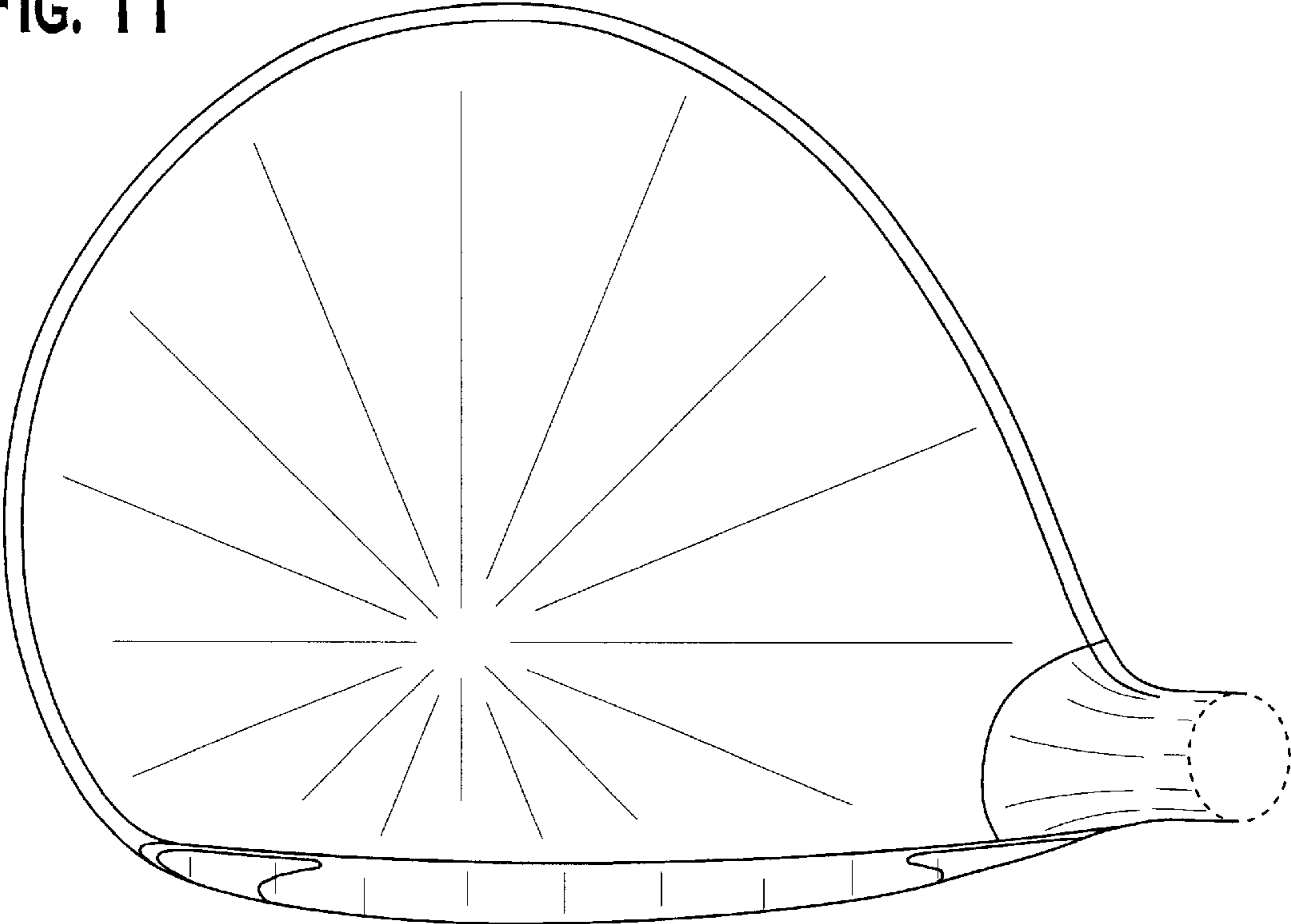

FIG. 12

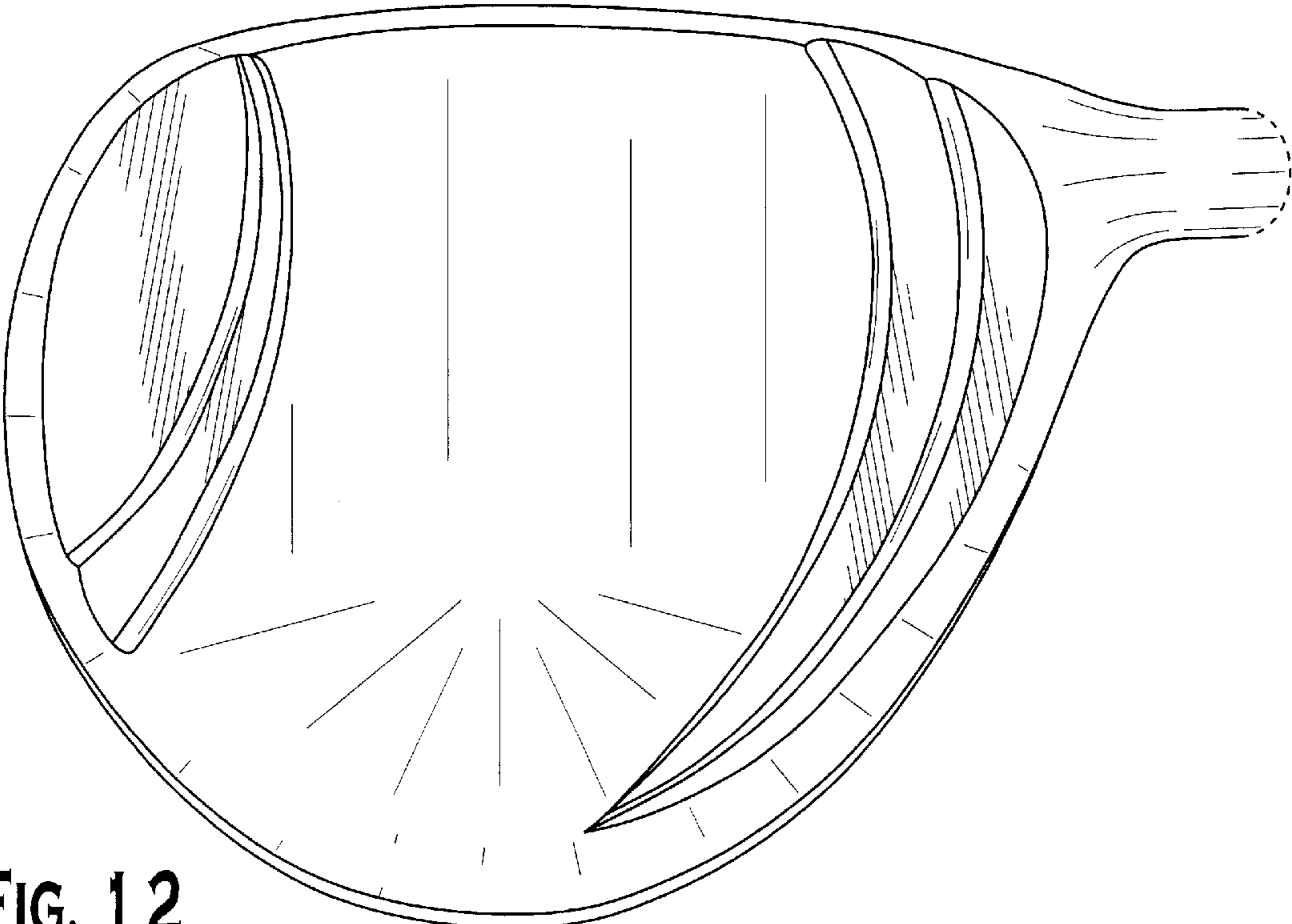

FIG. 13

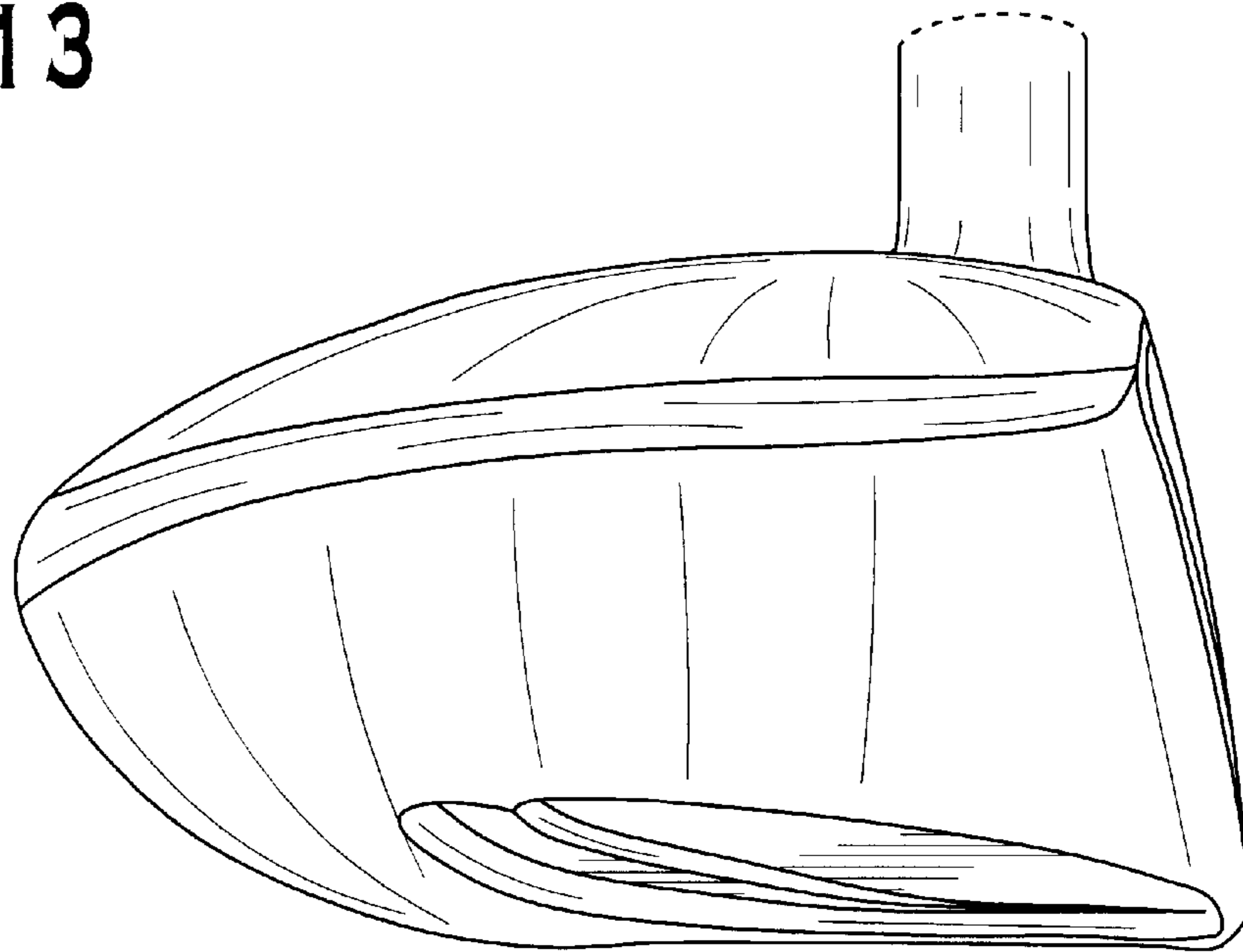

FIG. 14

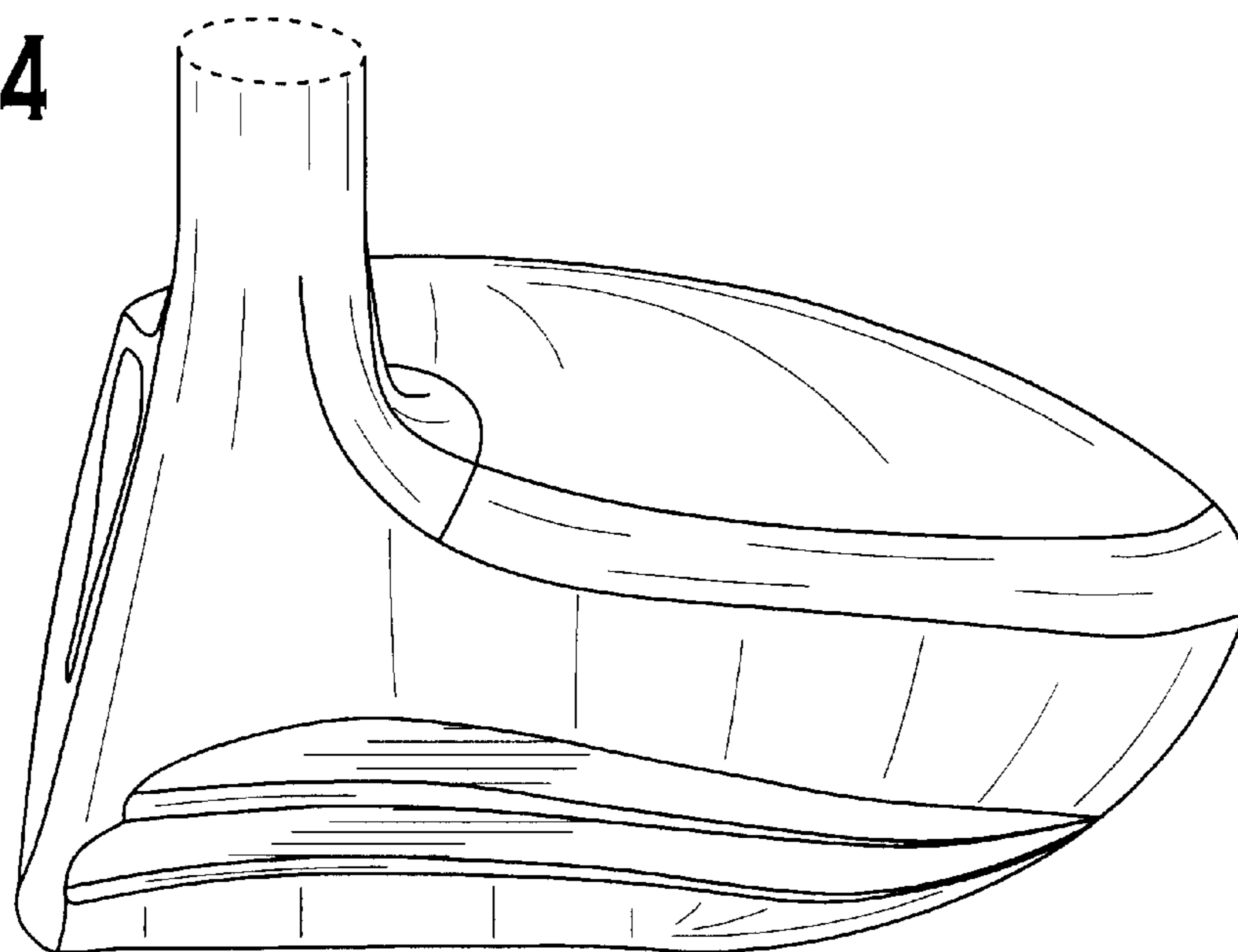

FIG. 15

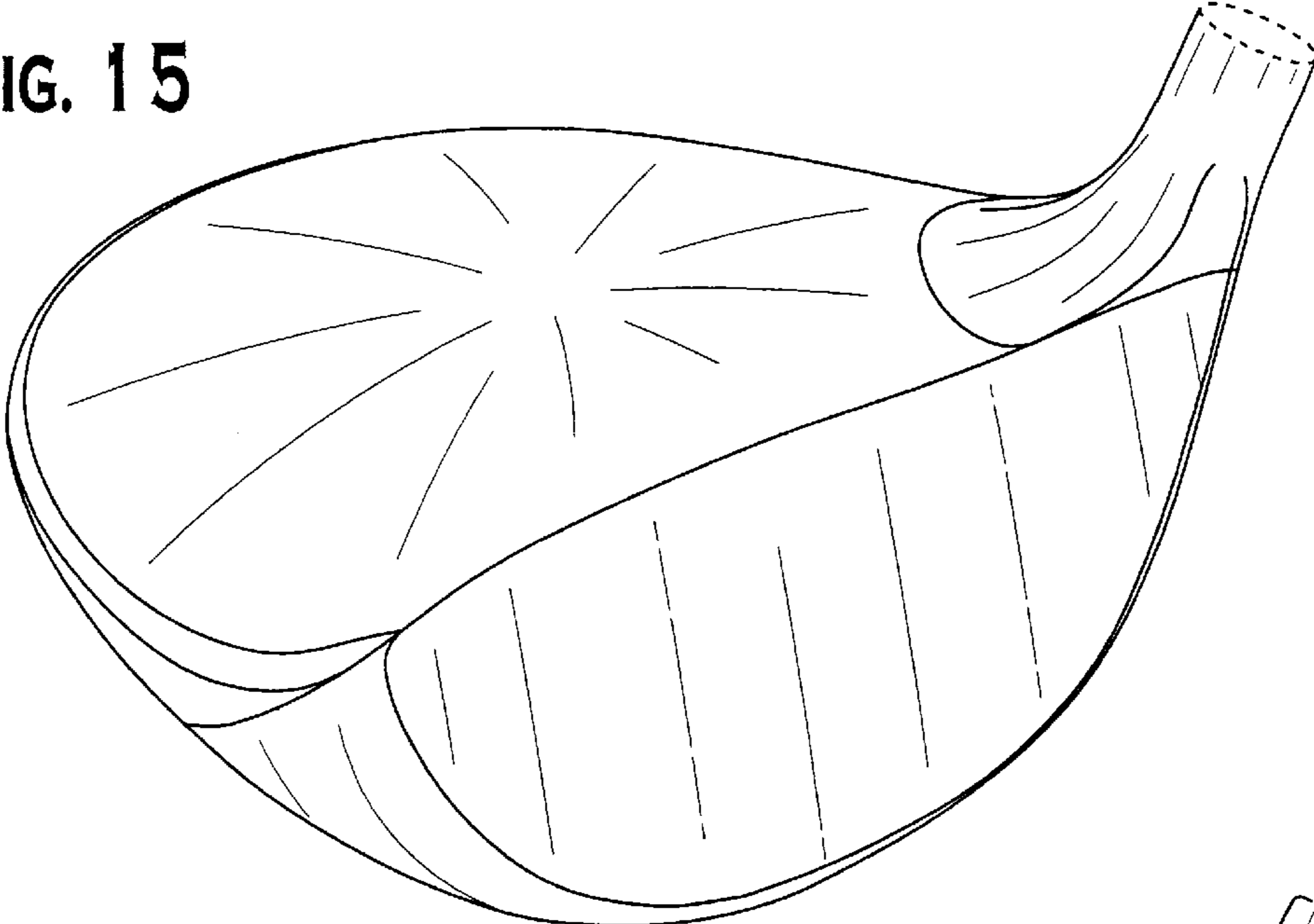

FIG. 16

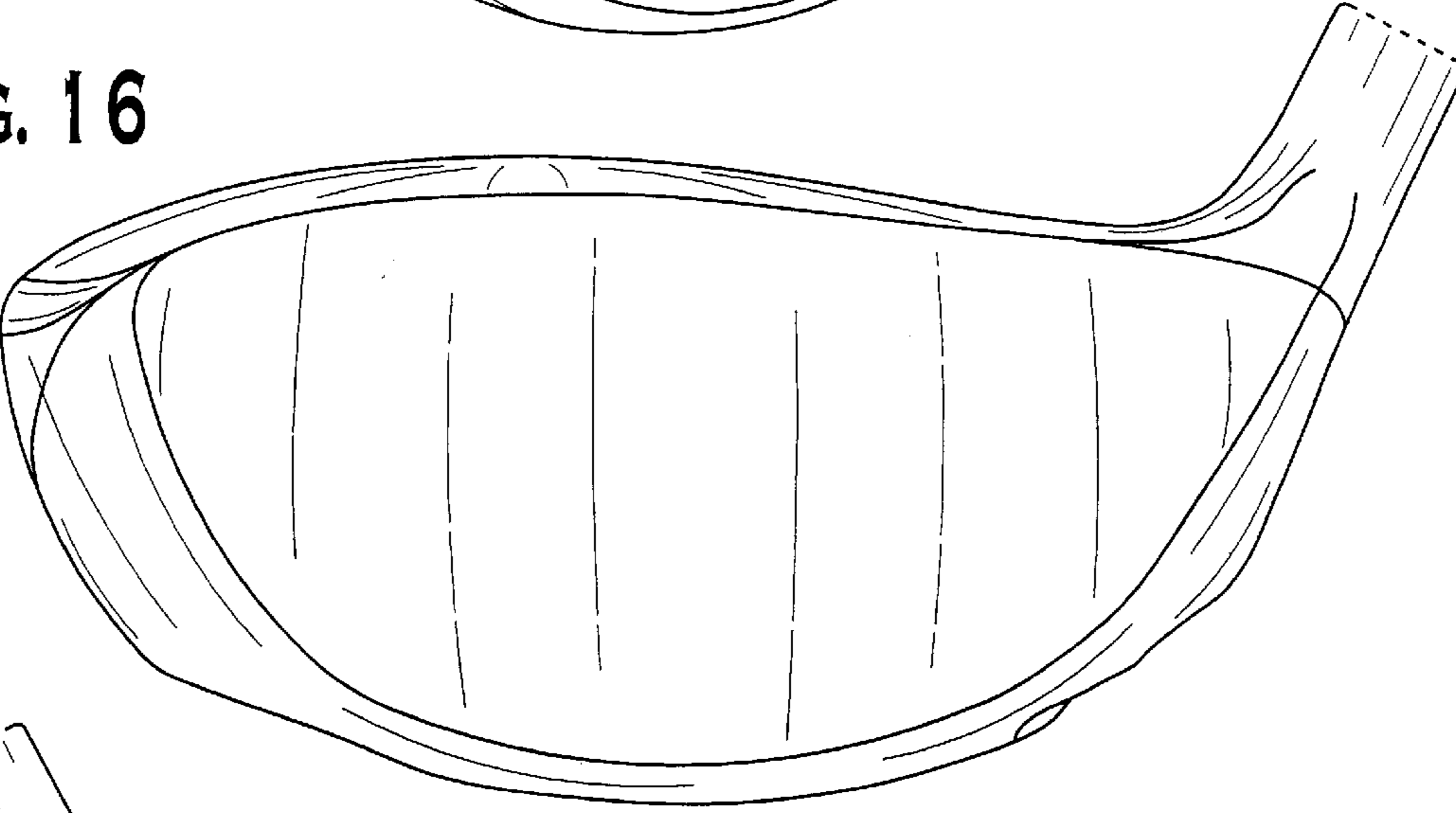

FIG. 17

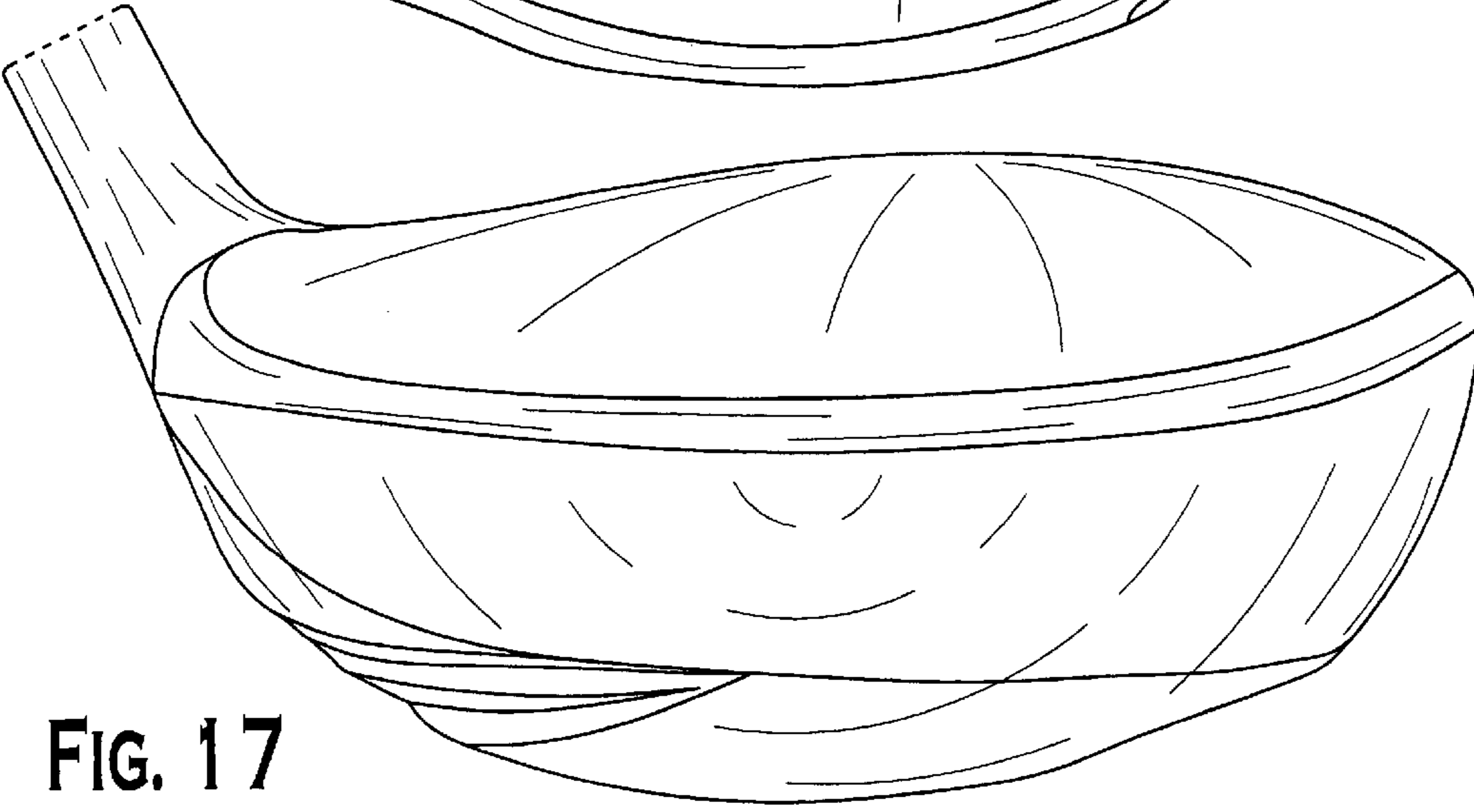

FIG. 18

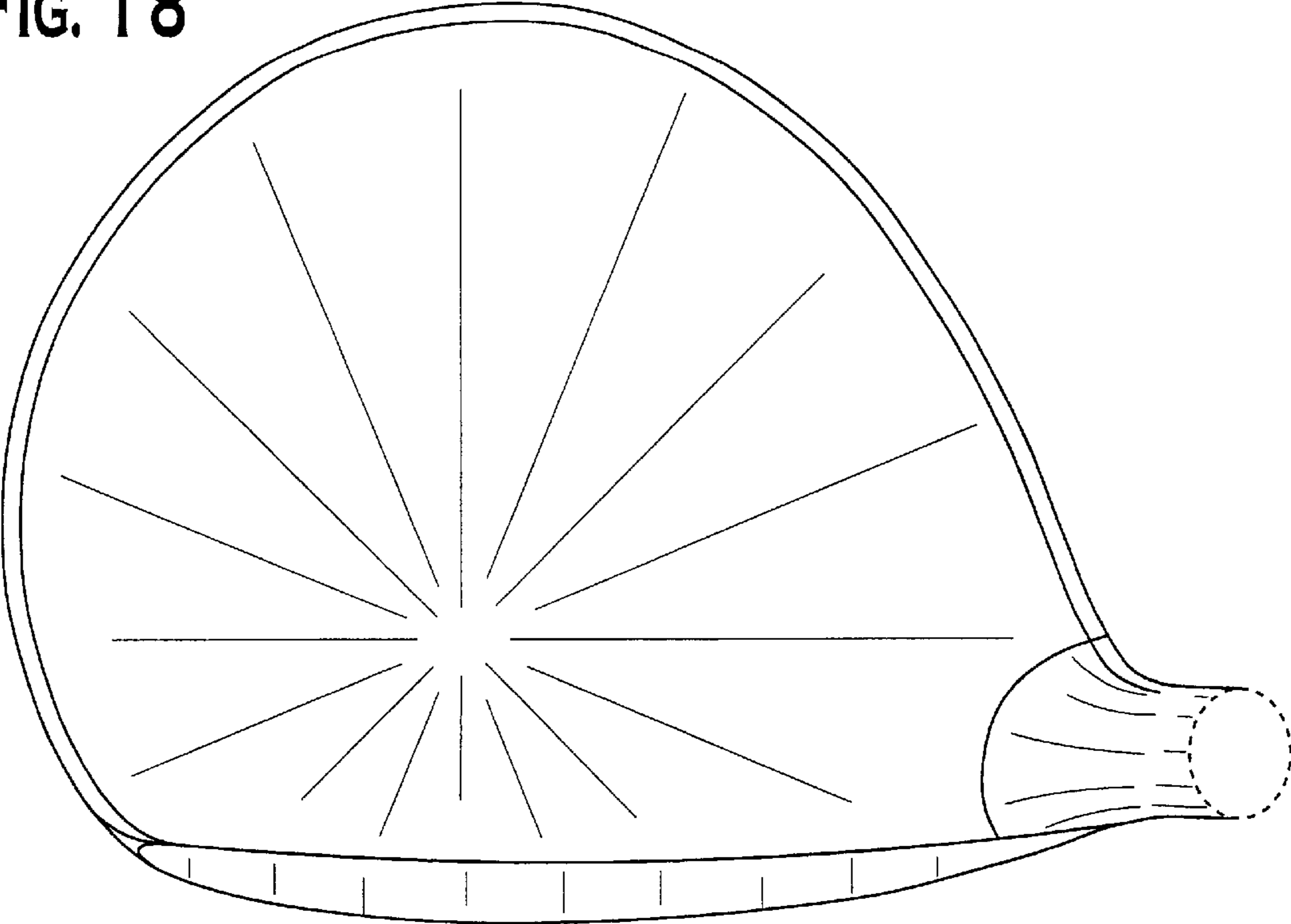

FIG. 19

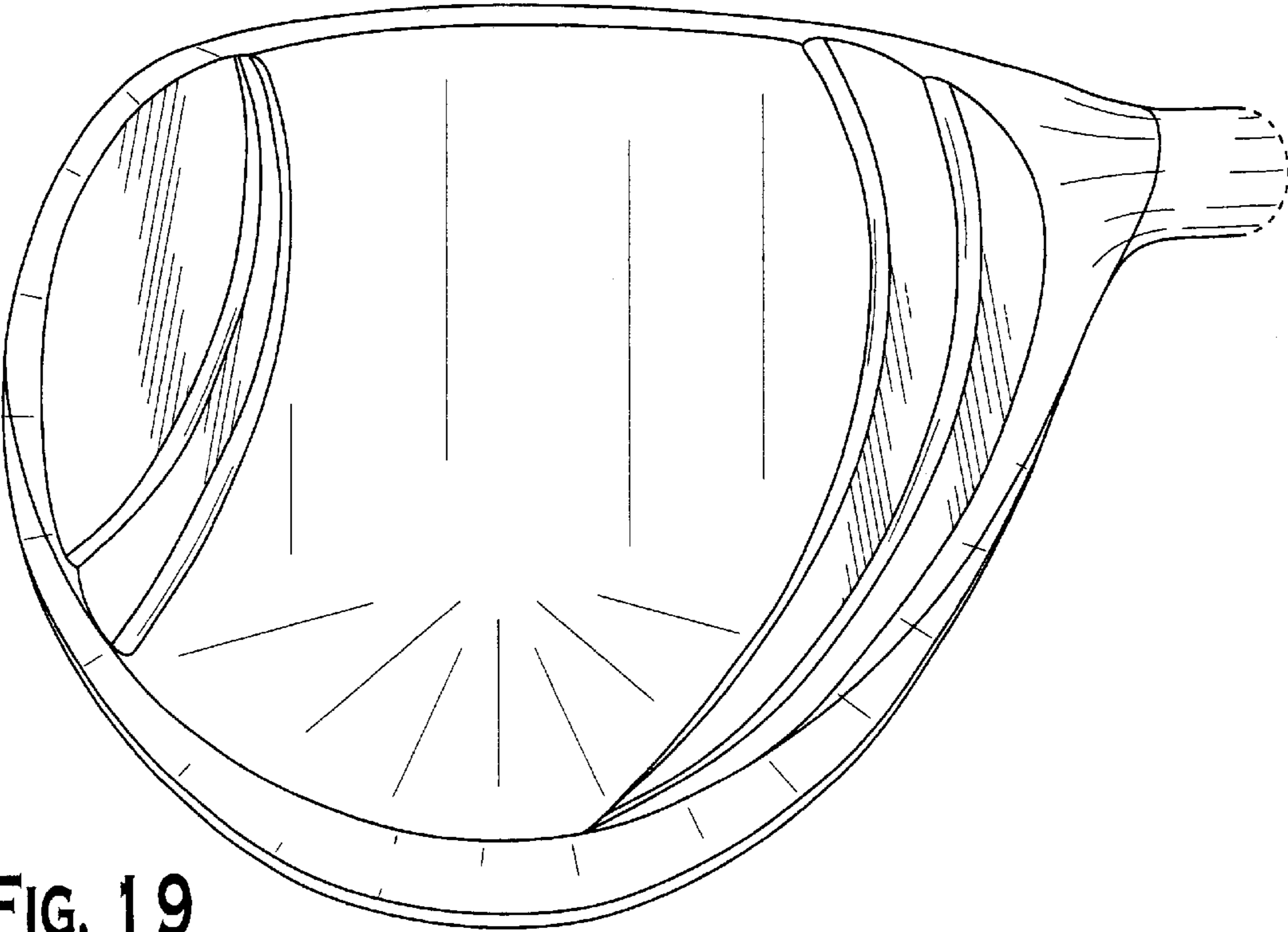

FIG. 20

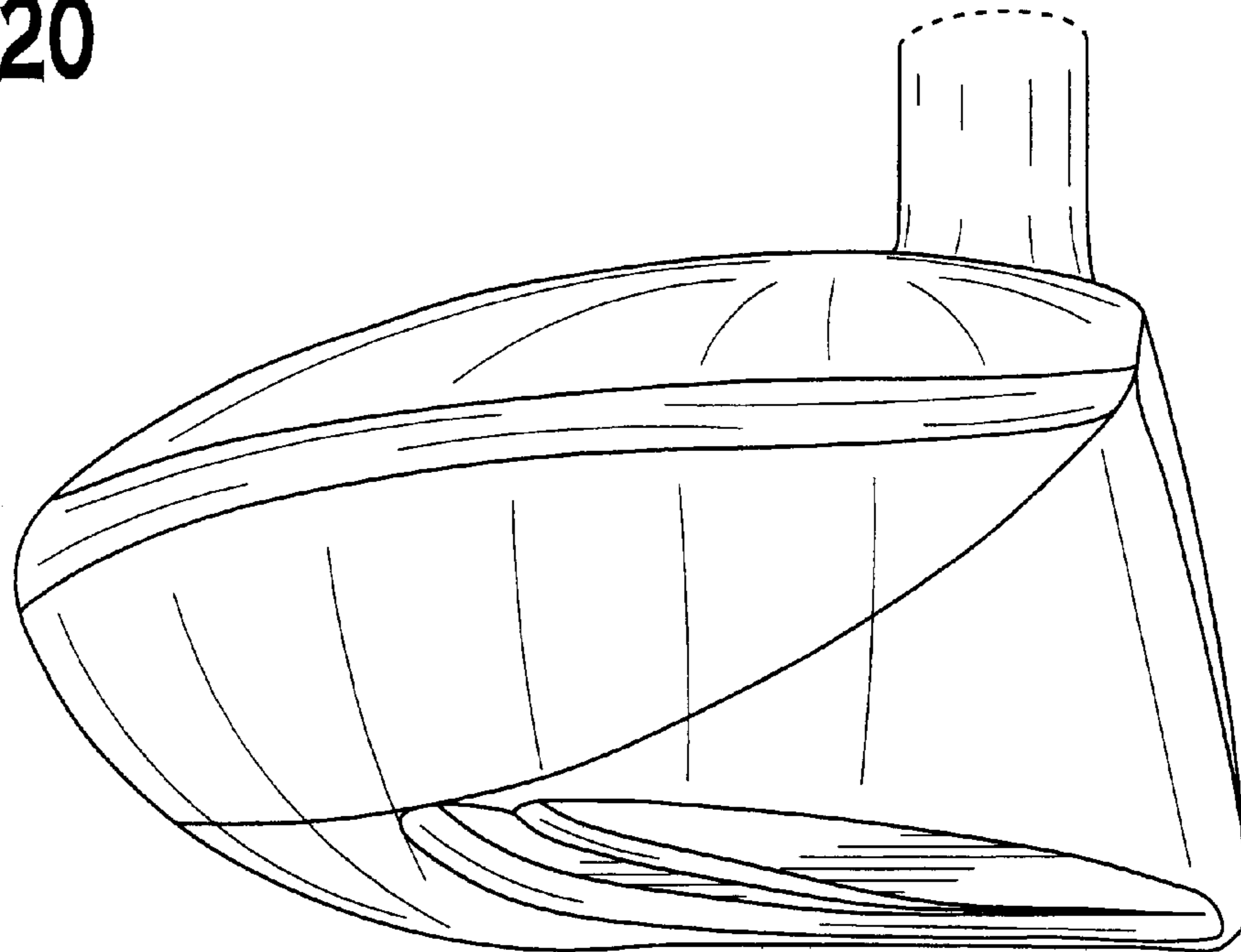

FIG. 21

