



US00D516091S

(12) **United States Design Patent** (10) **Patent No.:** **US D516,091 S**  
**Leasure et al.** (45) **Date of Patent:** **\*\* Feb. 28, 2006**

(54) **AIR COMPRESSOR**

D480,402 S \* 10/2003 Wilson et al. .... D15/7  
D489,733 S \* 5/2004 Leasure et al. .... D15/9

(75) Inventors: **Jeremy D. Leasure**, Jackson, TN (US);  
**Stephen J. Vos**, Jackson, TN (US);  
**Lance Hathcock**, Jackson, TN (US)

\* cited by examiner

(73) Assignee: **Black & Decker Inc.**, Newark, DE  
(US)

*Primary Examiner*—Ralf Seifert  
(74) *Attorney, Agent, or Firm*—Suiter West Swantz pc llo

(\*\*) Term: **14 Years**

(57) **CLAIM**

We claim the ornamental design for an air compressor, as shown.

(21) Appl. No.: **29/213,602**

**DESCRIPTION**

(22) Filed: **Sep. 20, 2004**

**Related U.S. Application Data**

(63) Continuation-in-part of application No. 29/195,873, filed on Dec. 18, 2003, now Pat. No. Des. 499,429.

(51) **LOC (8) Cl.** ..... **15-02**

(52) **U.S. Cl.** ..... **D15/9**

(58) **Field of Classification Search** ..... D15/7-9;  
417/234-235, 229, 321, 360, 410-411, 265,  
417/415, 903, 405, 464; D26/38; 248/645;  
D23/231, 232

See application file for complete search history.

FIG. 1 is an isometric view of a first embodiment of an air compressor showing our new design; FIG. 2 is a top plan view of the first embodiment; FIG. 3 is left side elevation view of the first embodiment; FIG. 4 is a front elevation view of the first embodiment; FIG. 5 is a right side elevation view of the first embodiment; FIG. 6 is a rear elevation view of the first embodiment; FIG. 7 is a bottom plan view of the first embodiment; FIG. 8 is an isometric view of the air compressor in FIG. 1, shown with the handle extended; FIG. 9 is a top plan view of FIG. 8; FIG. 10 is left side elevation view of FIG. 8; FIG. 11 is a front elevation view of FIG. 8; FIG. 12 is a right side elevation view of FIG. 8; FIG. 13 is a rear elevation view of FIG. 8; and, FIG. 14 is a bottom plan view of FIG. 8.

(56) **References Cited**

**U.S. PATENT DOCUMENTS**

D390,574 S \* 2/1998 Ashcraft ..... D15/9  
D479,248 S \* 9/2003 Gist et al. .... D15/9

**1 Claim, 6 Drawing Sheets**

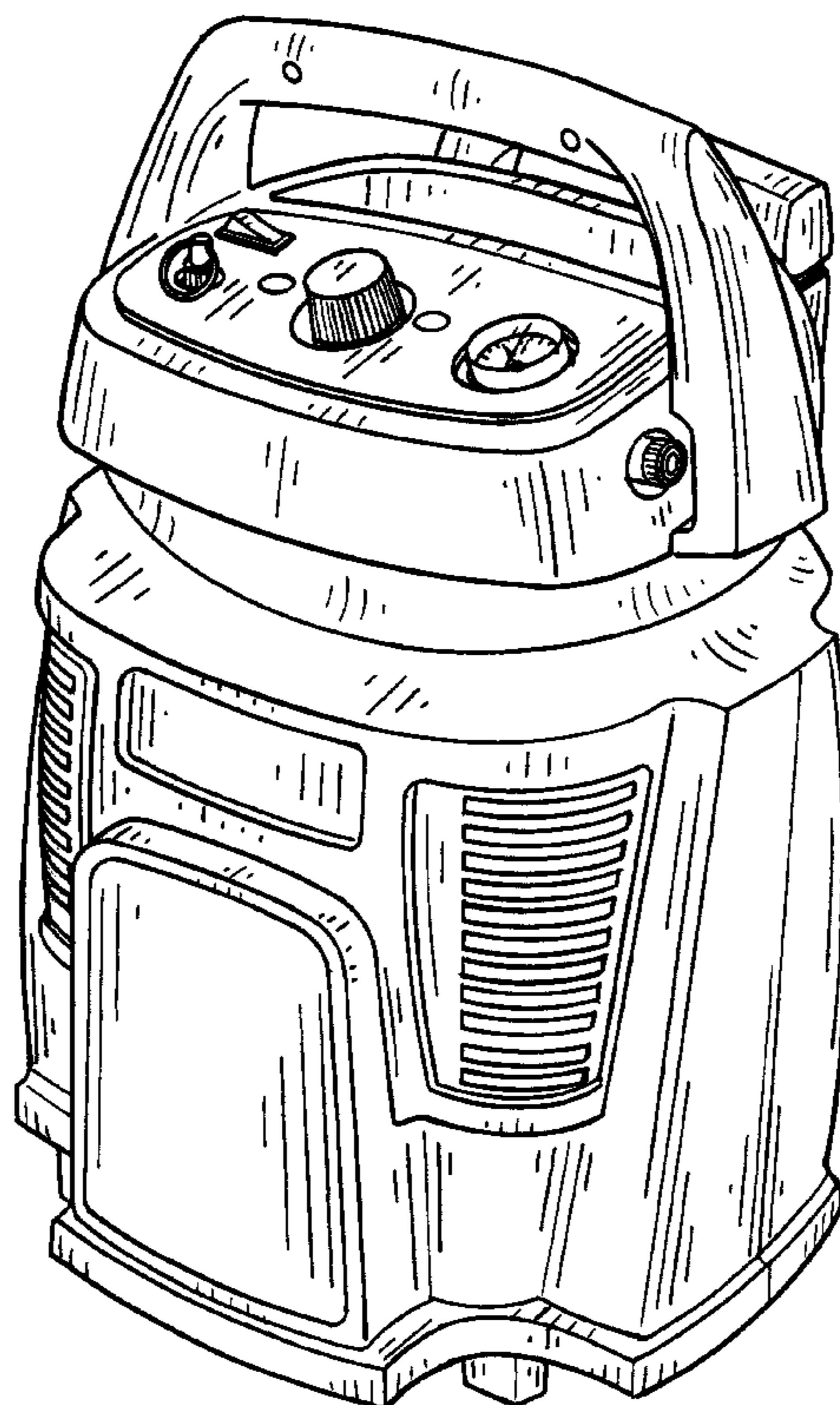

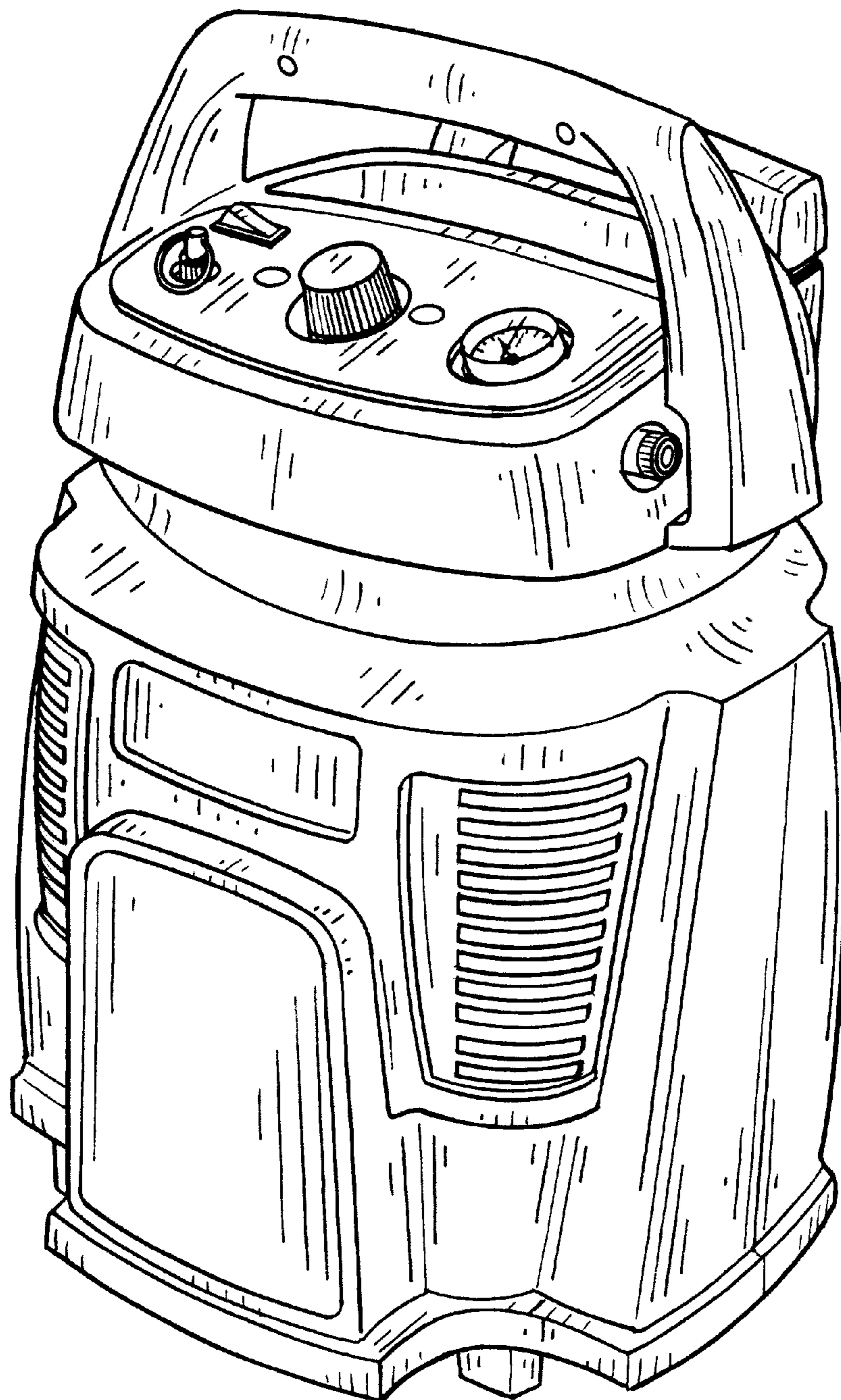

FIG. 1

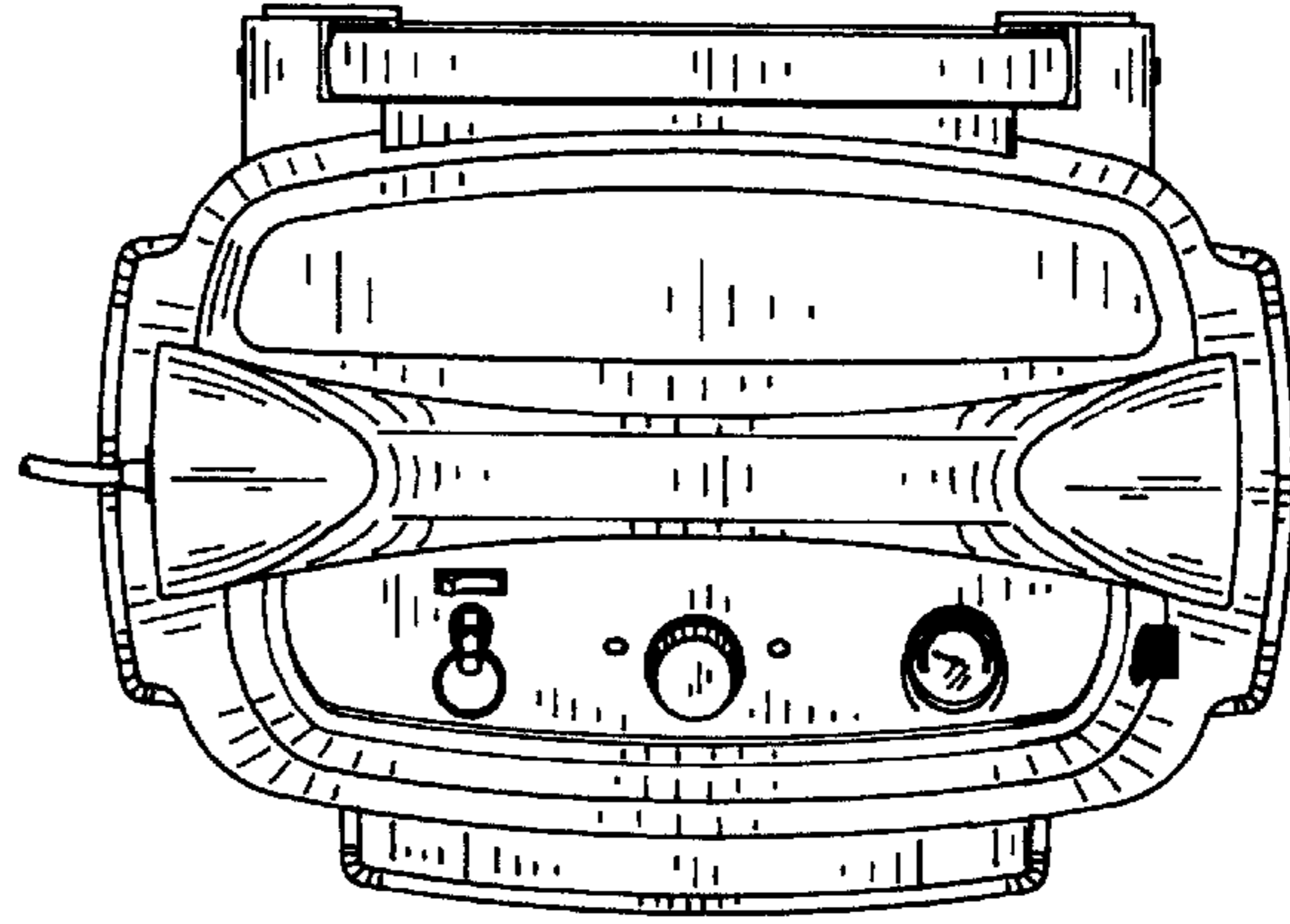

FIG. 2

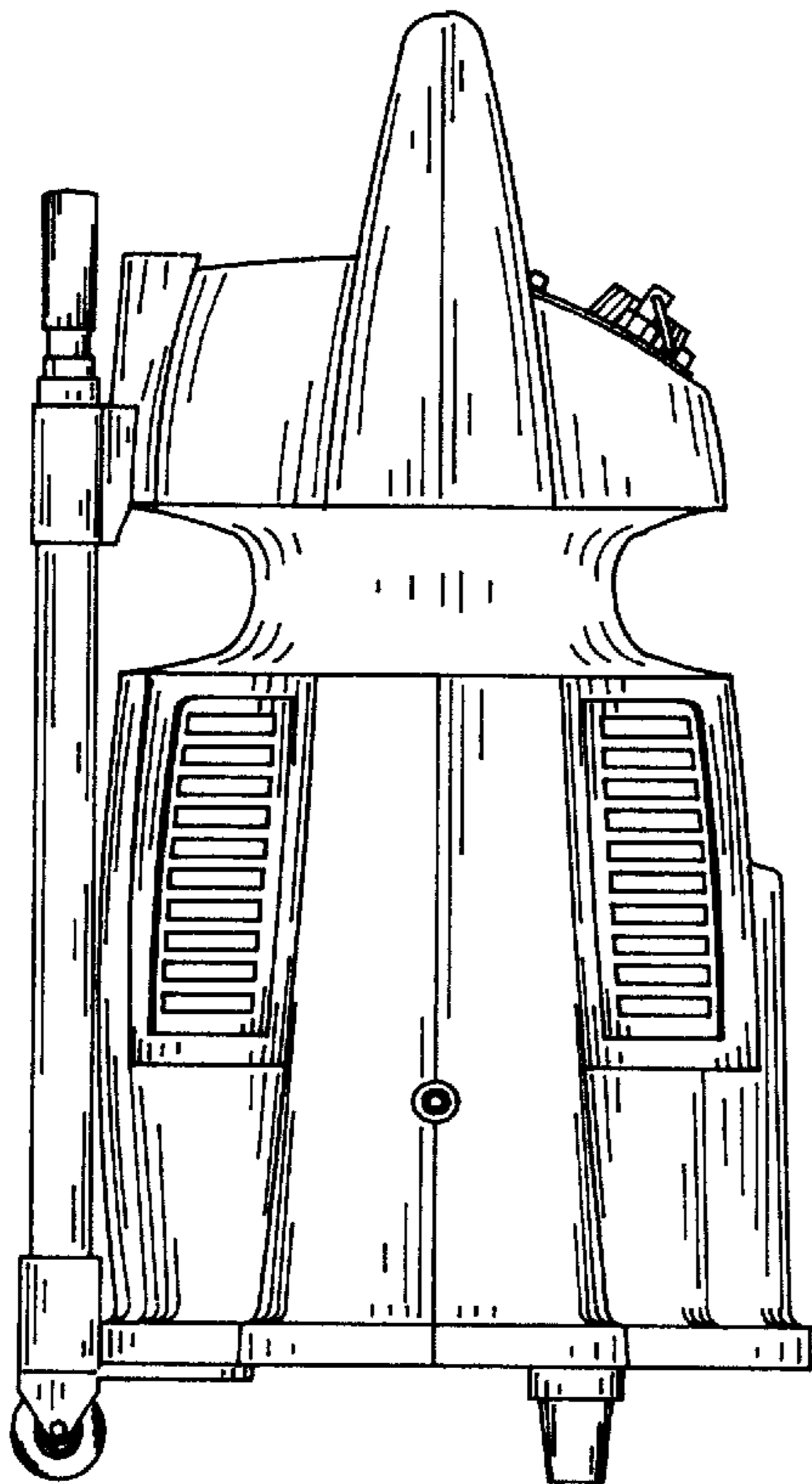

FIG. 3

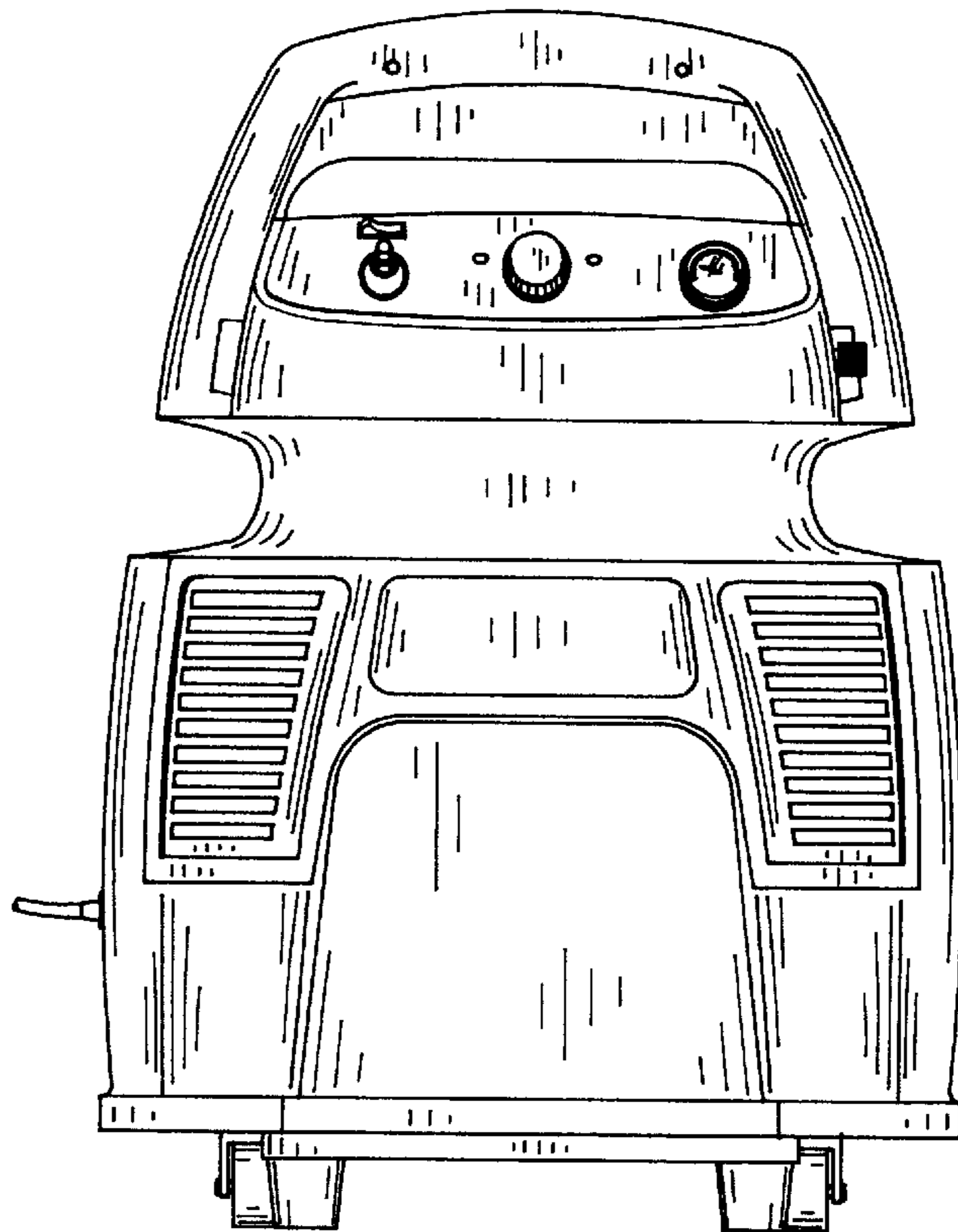

FIG. 4

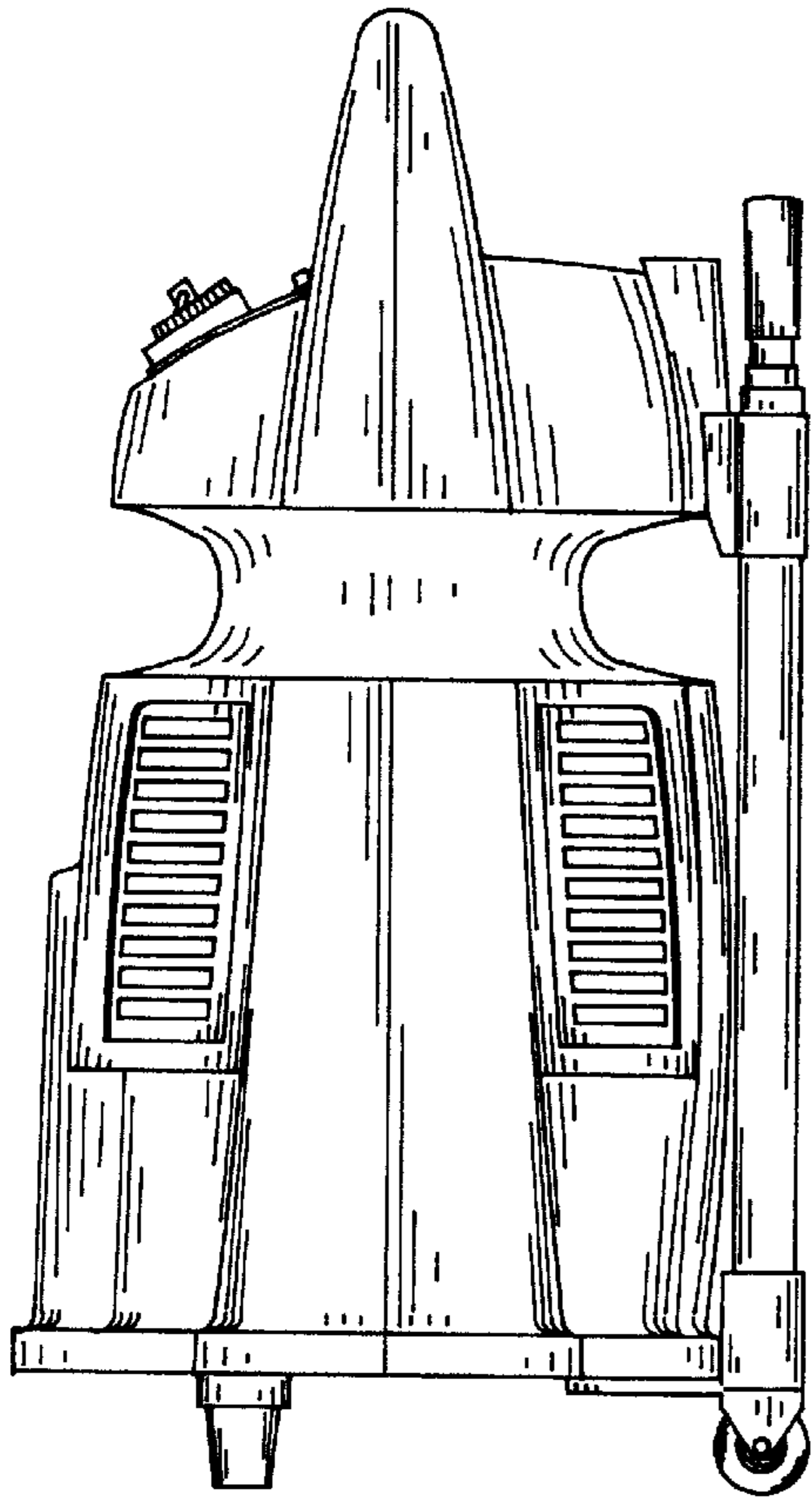

FIG. 5

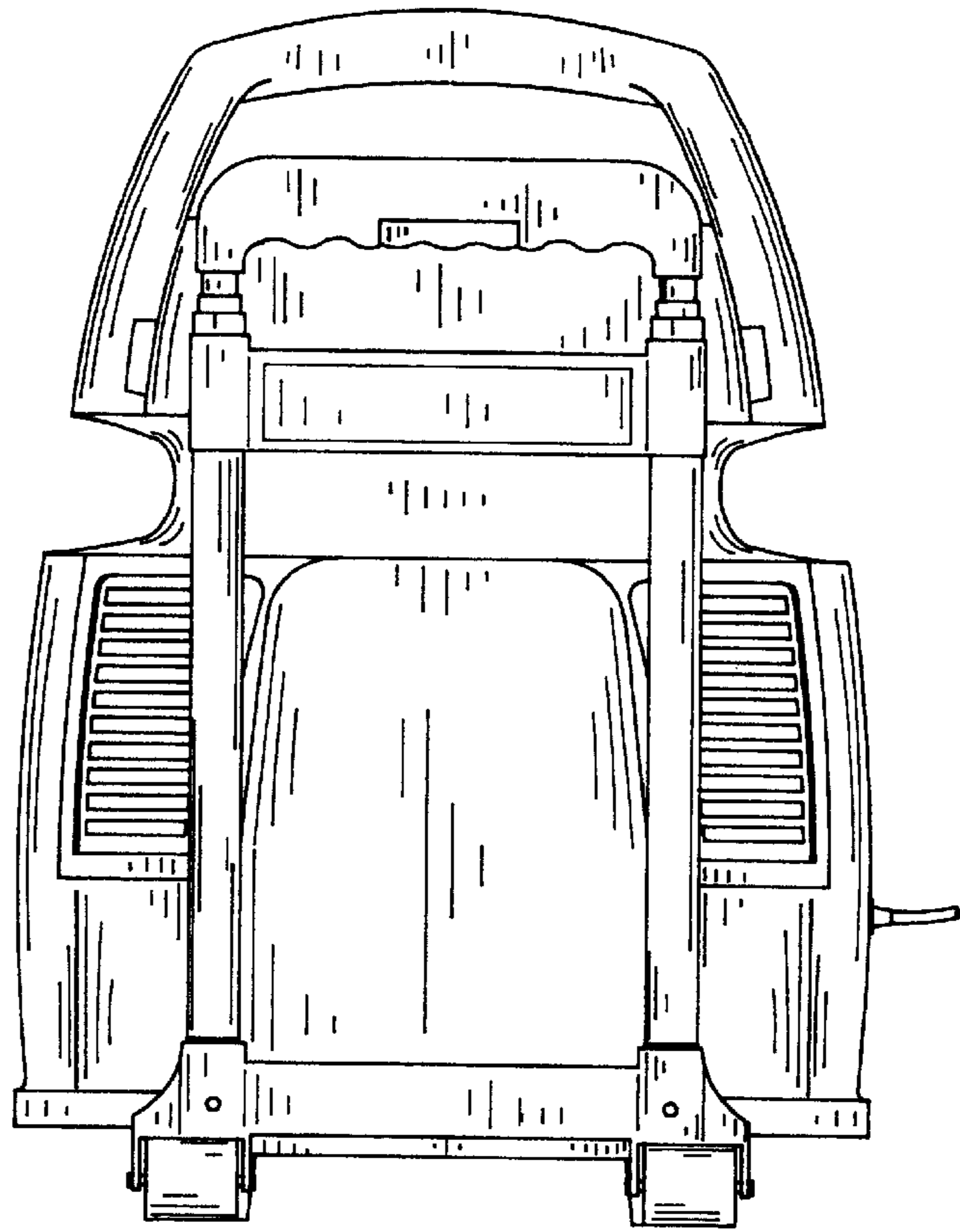

FIG. 6

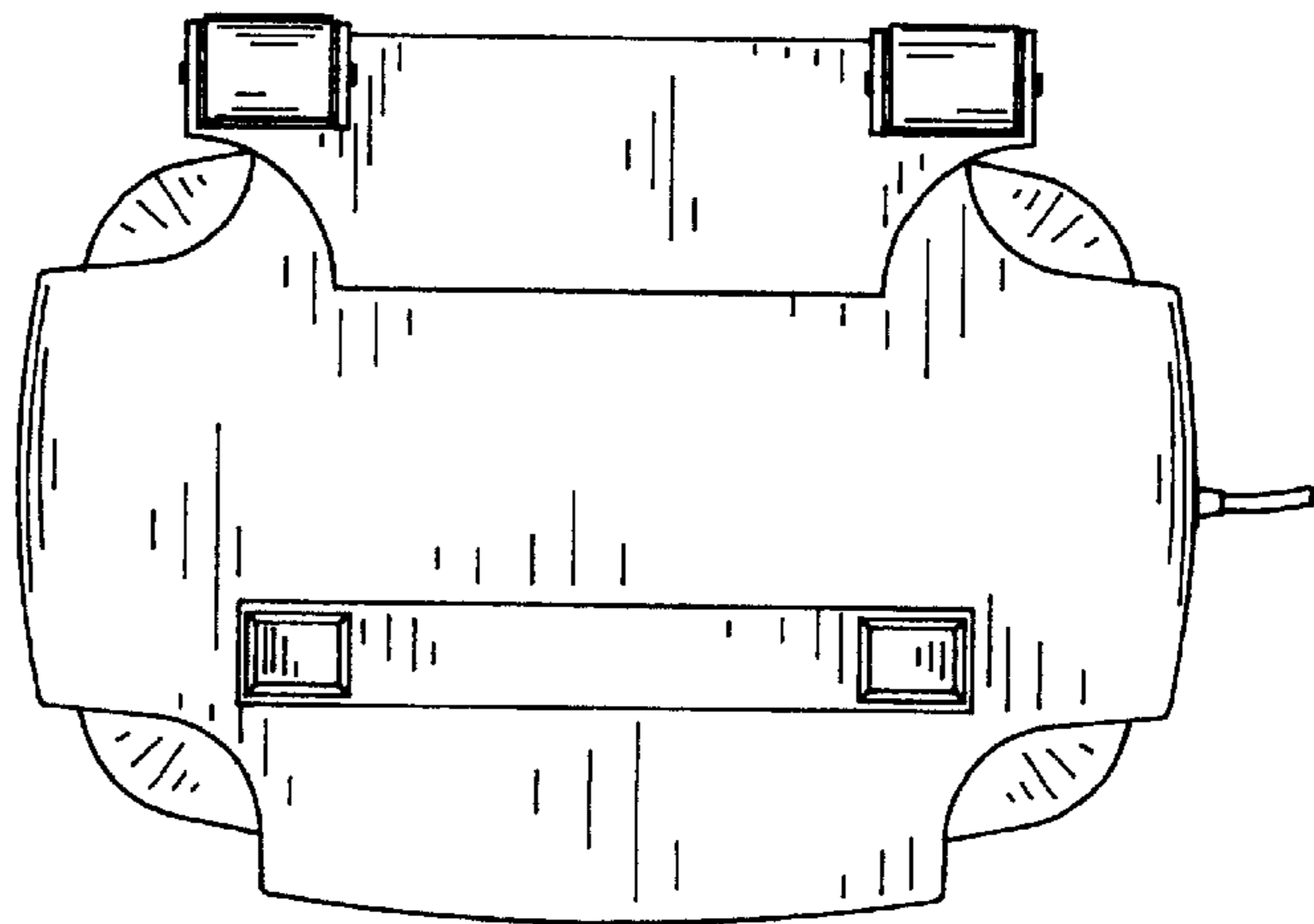

FIG. 7

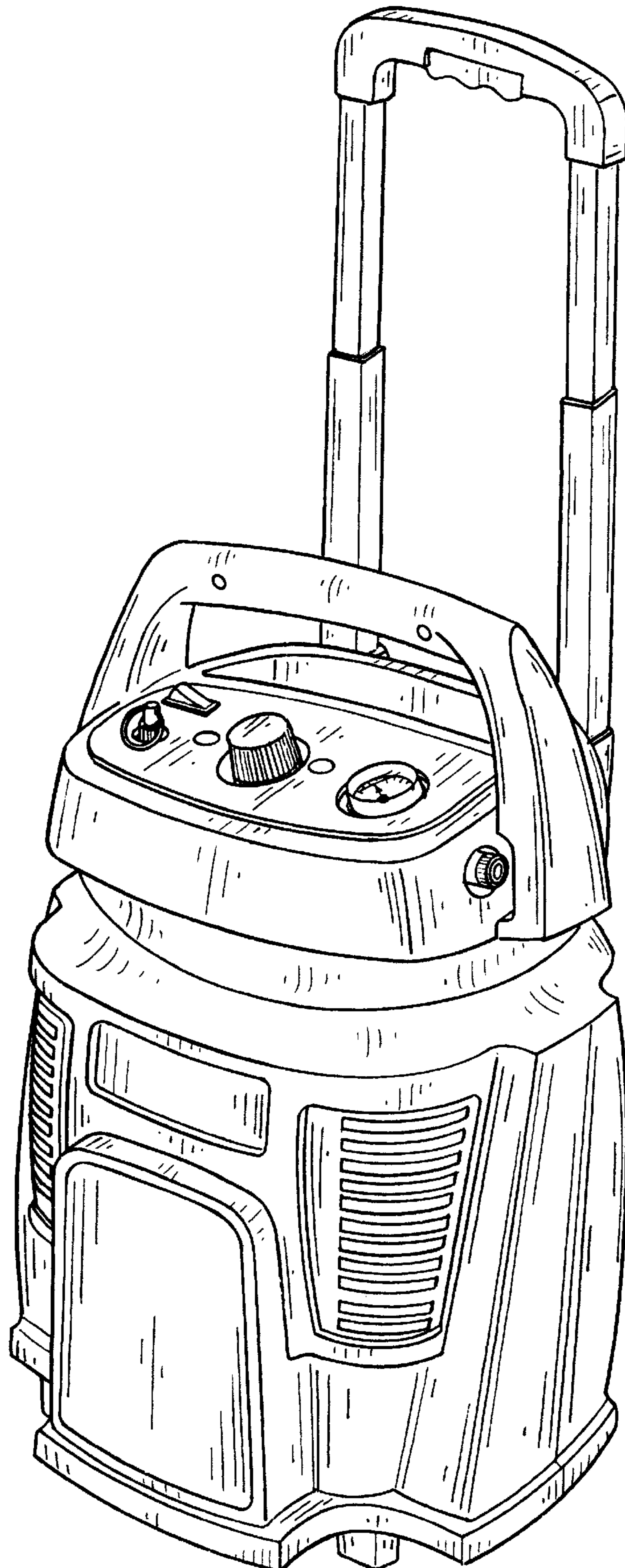

FIG. 8

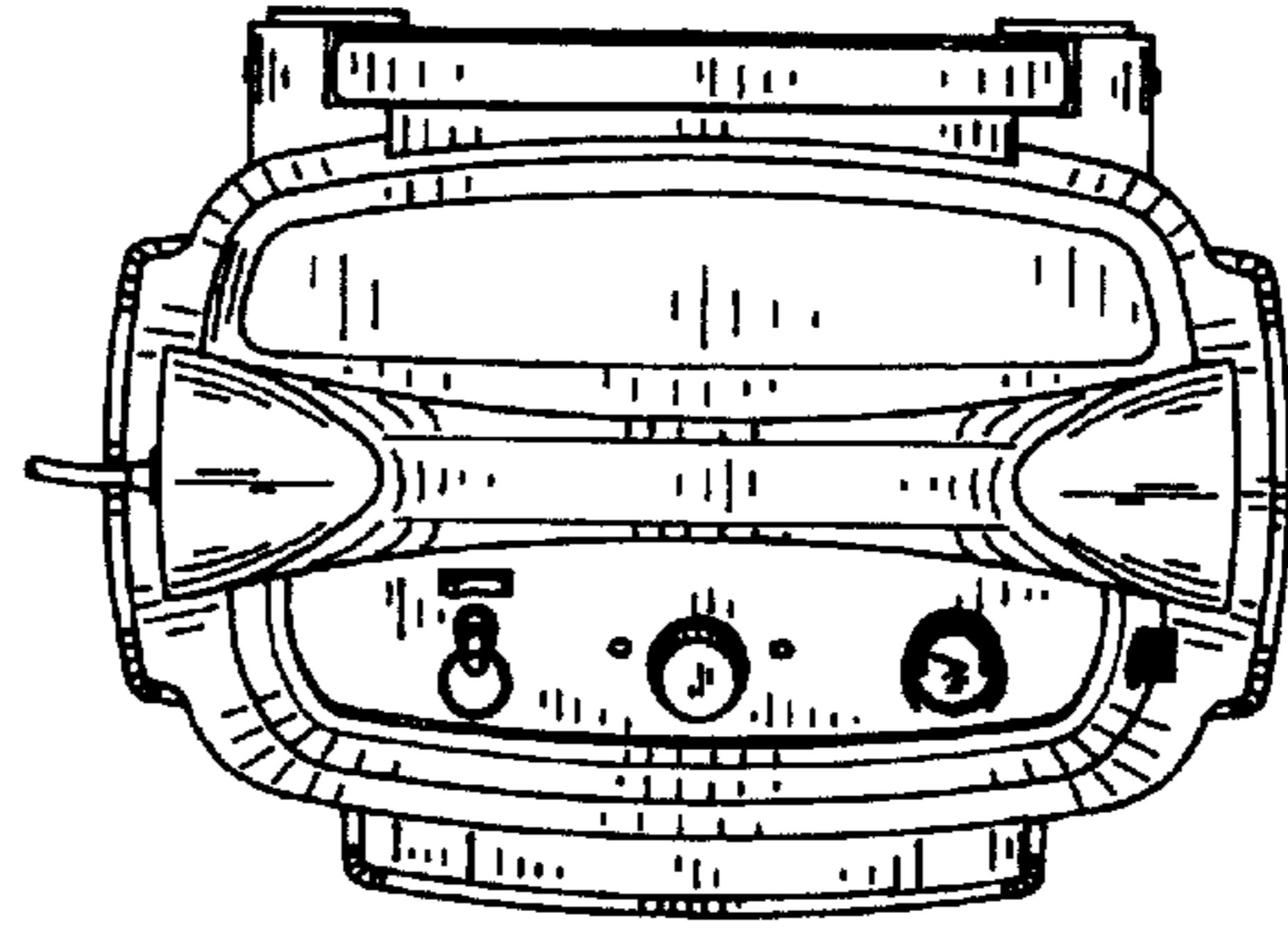

FIG. 9

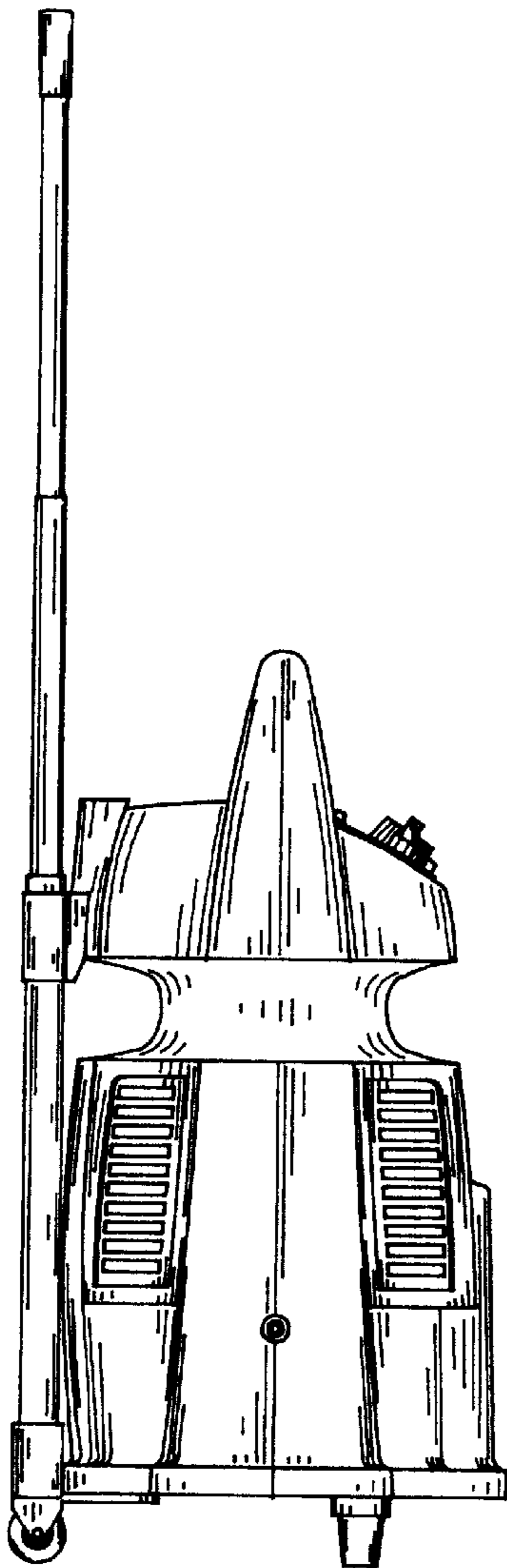

FIG. 10

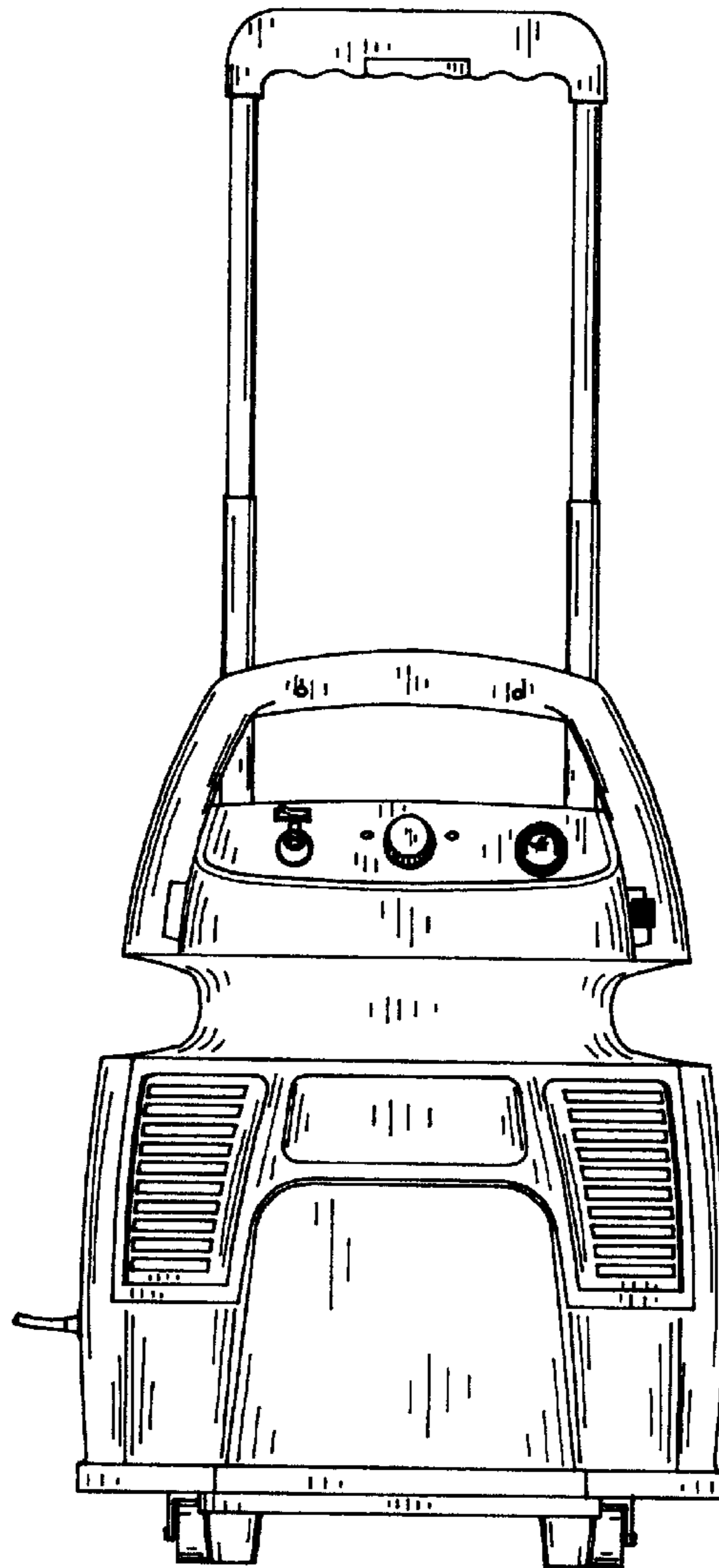

FIG. 11

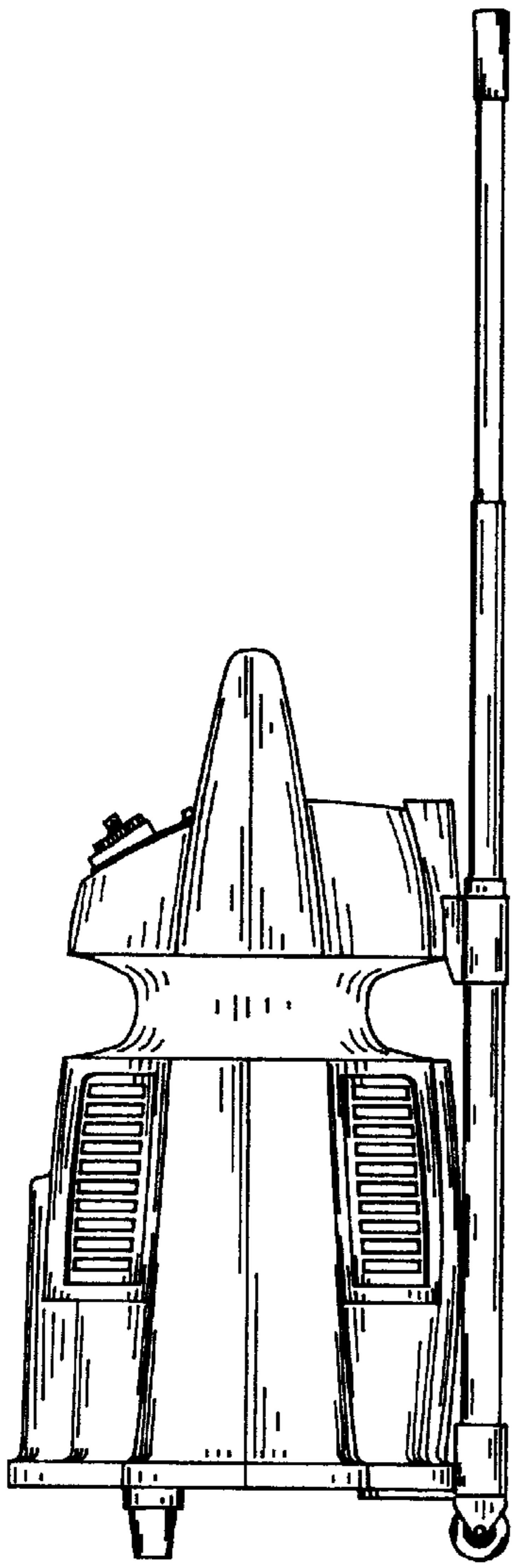

FIG. 12

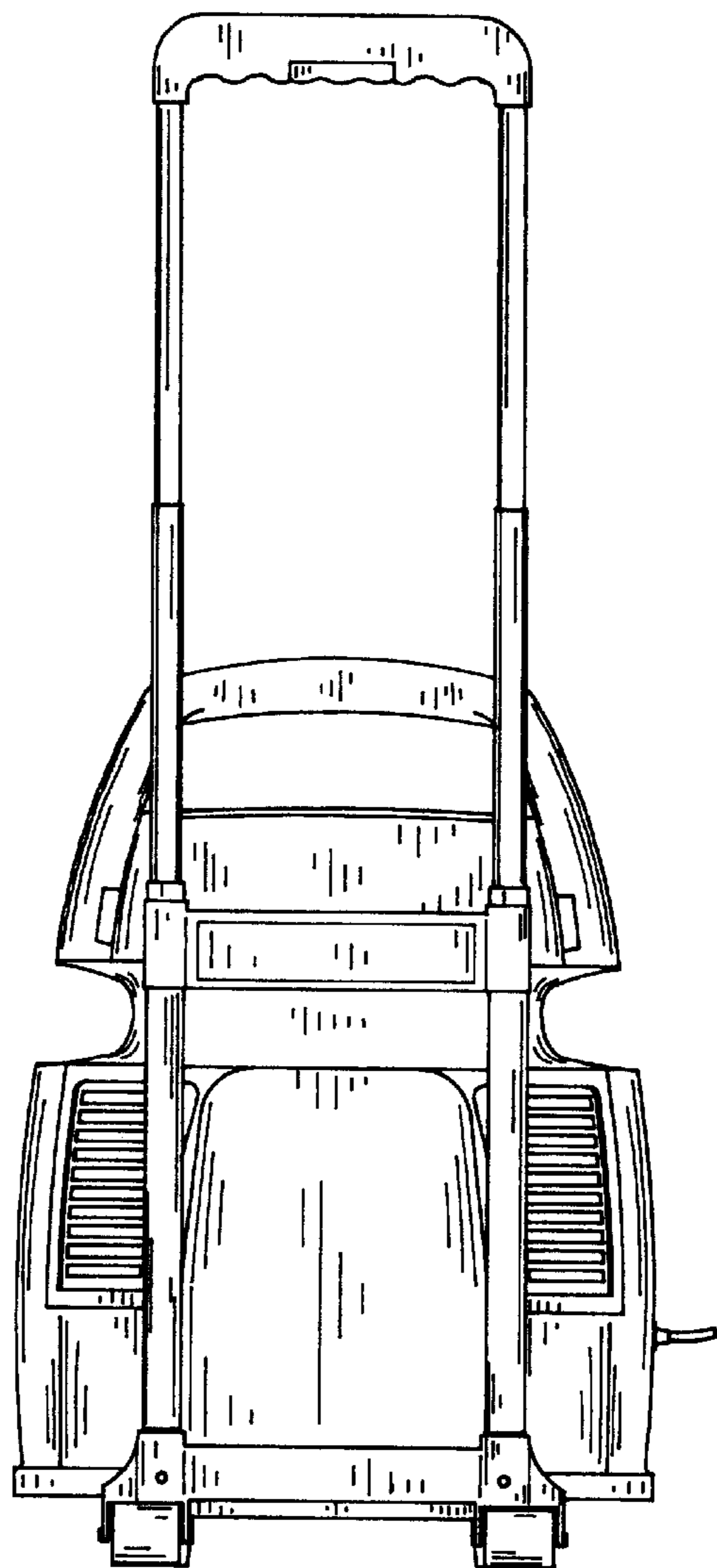

FIG. 13

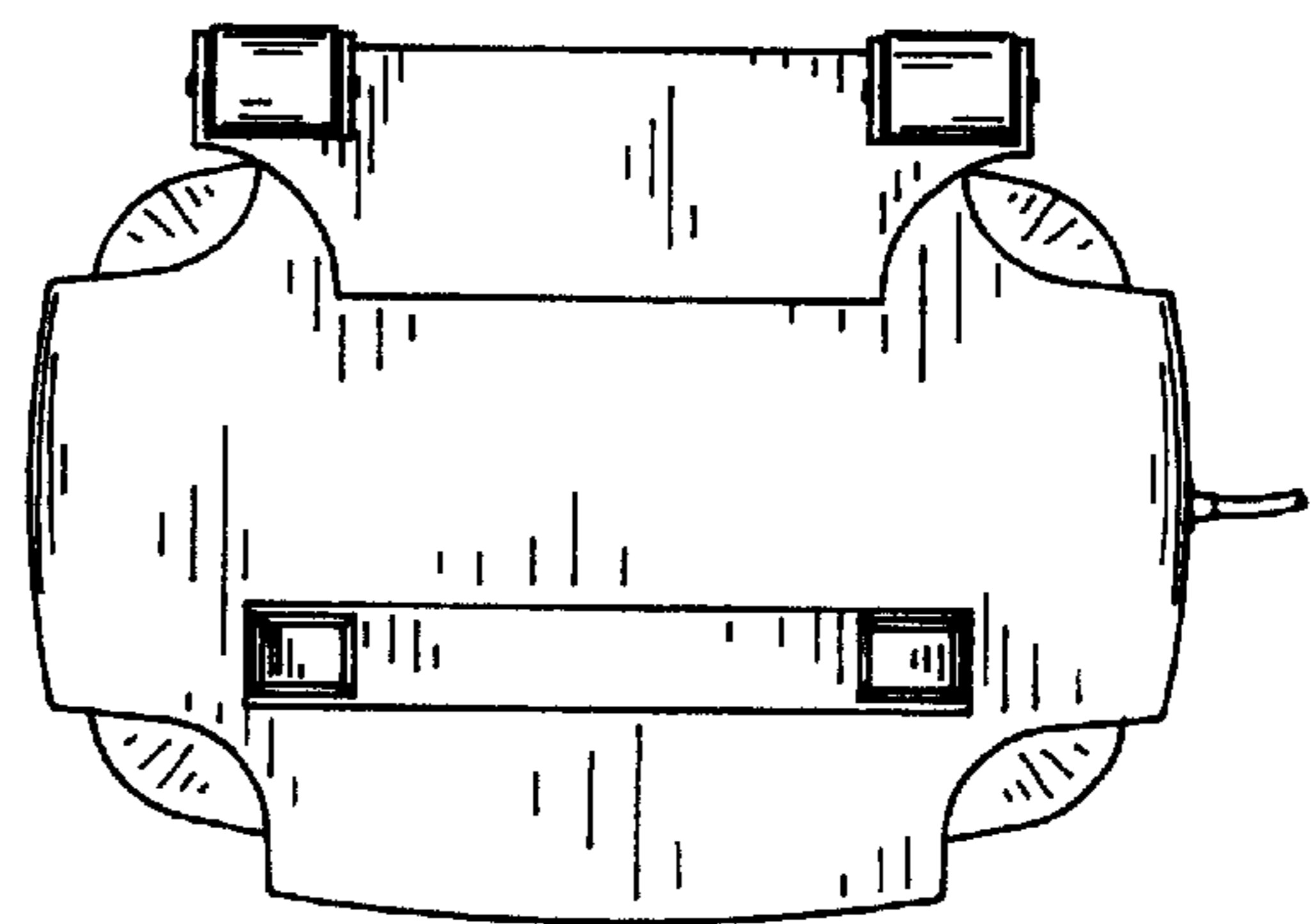

FIG. 14