

US00D516042S

(12) **United States Design Patent** (10) **Patent No.:** **US D516,042 S**  
**Butler et al.** (45) **Date of Patent:** **\*\* \*Feb. 28, 2006**

(54) **WALL-MOUNTABLE CONTROL PANEL**

(56) **References Cited**

(75) Inventors: **Nathan J. Butler**, Harleysville, PA (US); **Elliot G. Jacoby**, Glenside, PA (US); **Timothy S. Majewski**, New Tripoli, PA (US); **Noel Mayo**, Philadelphia, PA (US); **Stephen S. Thompson**, London (GB); **Joel S. Spira**, Coopersburg, PA (US)

U.S. PATENT DOCUMENTS

D287,242 S	*	12/1986	Liss et al. ....	D13/177
D313,738 S	*	1/1991	Mayo et al. ....	D8/353
5,030,893 A	*	7/1991	Spira et al. ....	178/18.08
5,463,286 A	*	10/1995	D'Aleo et al. ....	315/295
D436,930 S	*	1/2001	Butler .....	D13/162
D453,742 S	*	2/2002	Butler et al. ....	D13/164
D456,783 S	*	5/2002	Mayo et al. ....	D13/164
D490,061 S	*	5/2004	Bennett et al. ....	D13/169

(73) Assignee: **Lutron Electronics Co., Inc.**, Coopersburg, PA (US)

\* cited by examiner

(\*) Notice: This patent is subject to a terminal disclaimer.

*Primary Examiner*—Stella Reid  
*Assistant Examiner*—Selina Sikder  
(74) *Attorney, Agent, or Firm*—Drinkler Biddle & Reath LLP

(\*\*) Term: **14 Years**

(57) **CLAIM**

(21) Appl. No.: **29/214,143**

The ornamental design for a wall-mountable control panel, as shown and described.

(22) Filed: **Sep. 28, 2004**

**Related U.S. Application Data**

**DESCRIPTION**

(63) Continuation-in-part of application No. 29/209,921, filed on Jul. 23, 2004.

(51) **LOC (8) Cl.** ..... **13-03**

(52) **U.S. Cl.** ..... **D13/164**

(58) **Field of Classification Search** ..... D13/162, D13/164, 170, 171, 177; D8/350, 353; 174/66, 174/67; 200/5 A, 5 R, 237, 293, 308, 310, 200/313, 314, 329, 341; 315/291, 295, 320; 338/184, 226

FIG. 1 is a front perspective view of a wall-mountable control panel showing our new design.  
FIG. 2 is a front elevation view thereof.  
FIG. 3 is a bottom view thereof.  
FIG. 4 is a top view thereof.  
FIG. 5 is a left side view thereof; and,  
FIG. 6 is a right side view thereof.  
The portions of the drawings appearing in broken line are for environment only and do not form a part of the design.

See application file for complete search history.

**1 Claim, 5 Drawing Sheets**

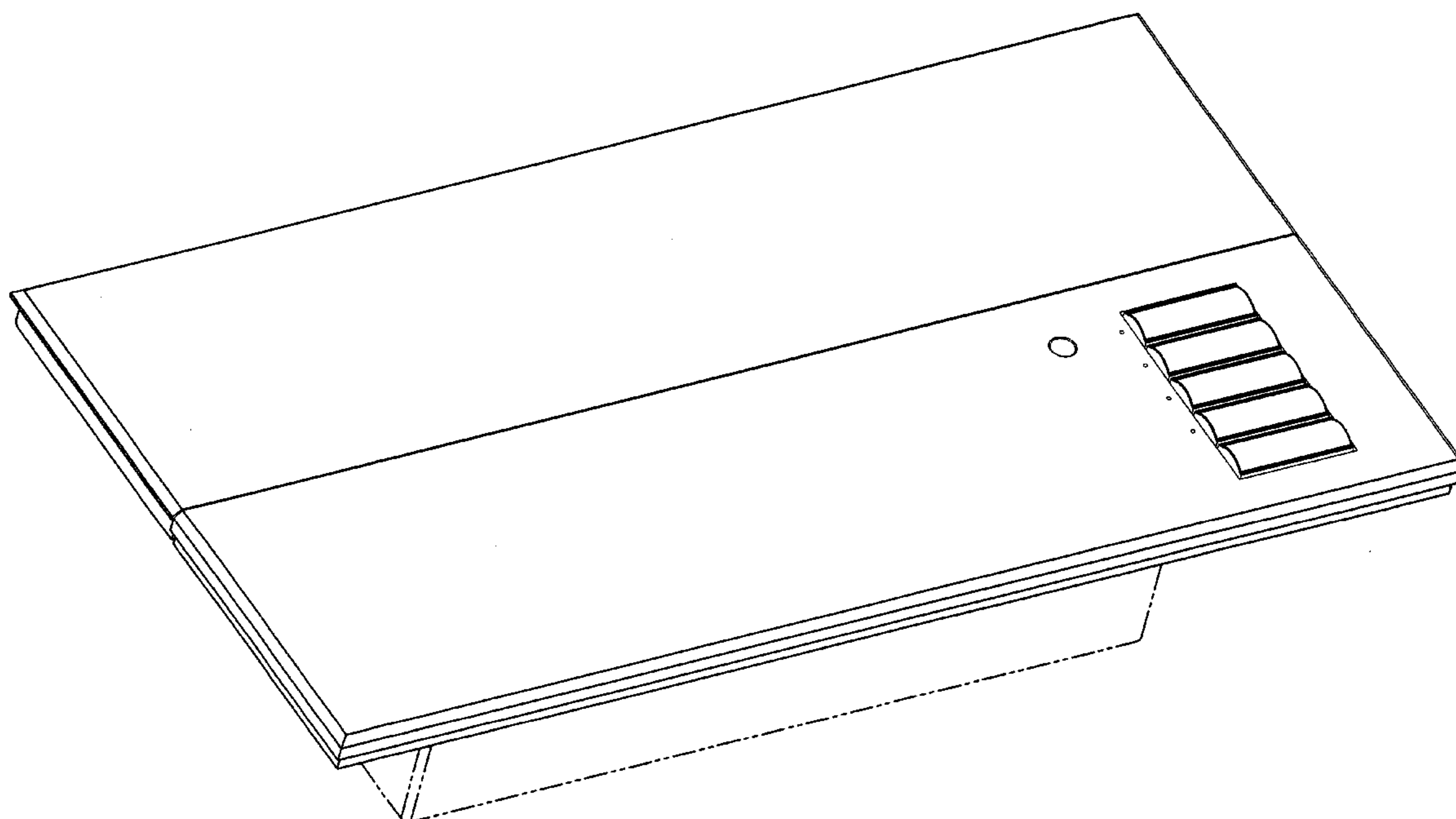

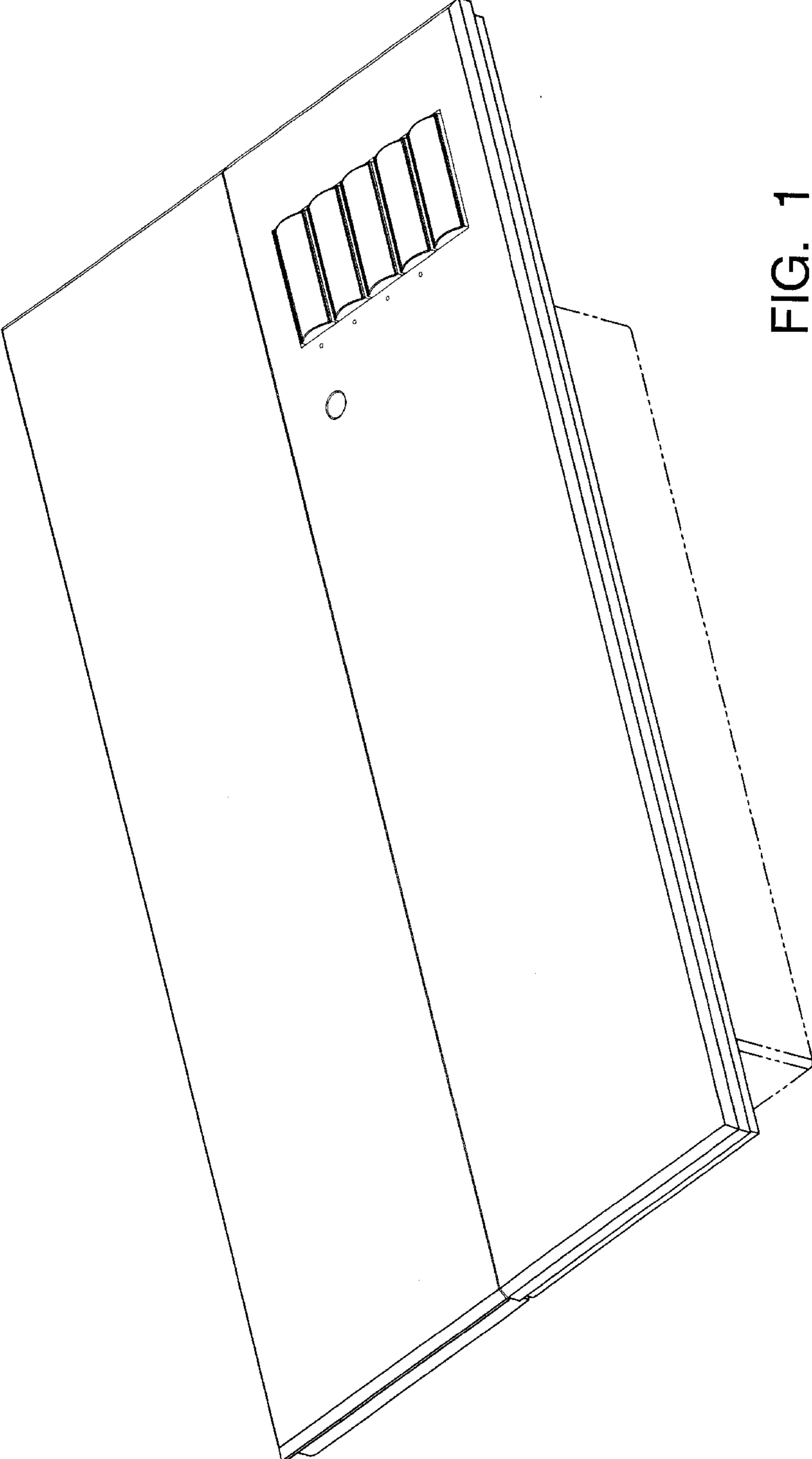

FIG. 1

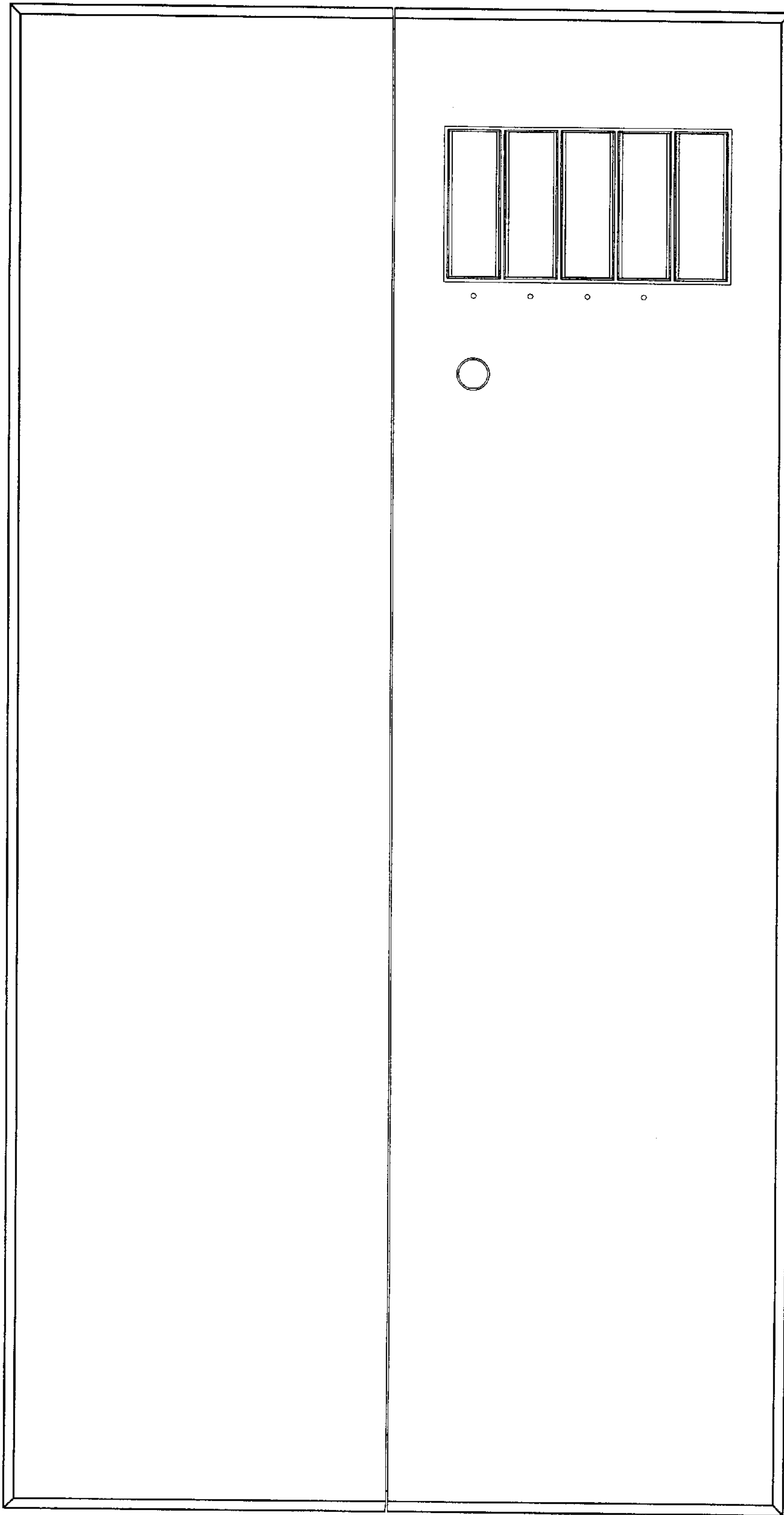

FIG. 2

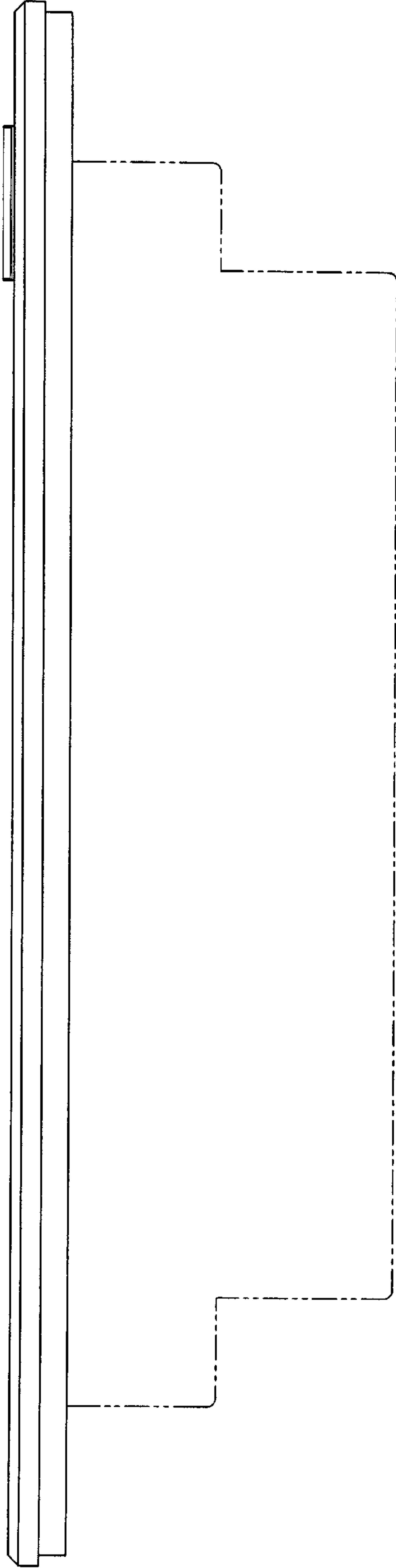

FIG. 3

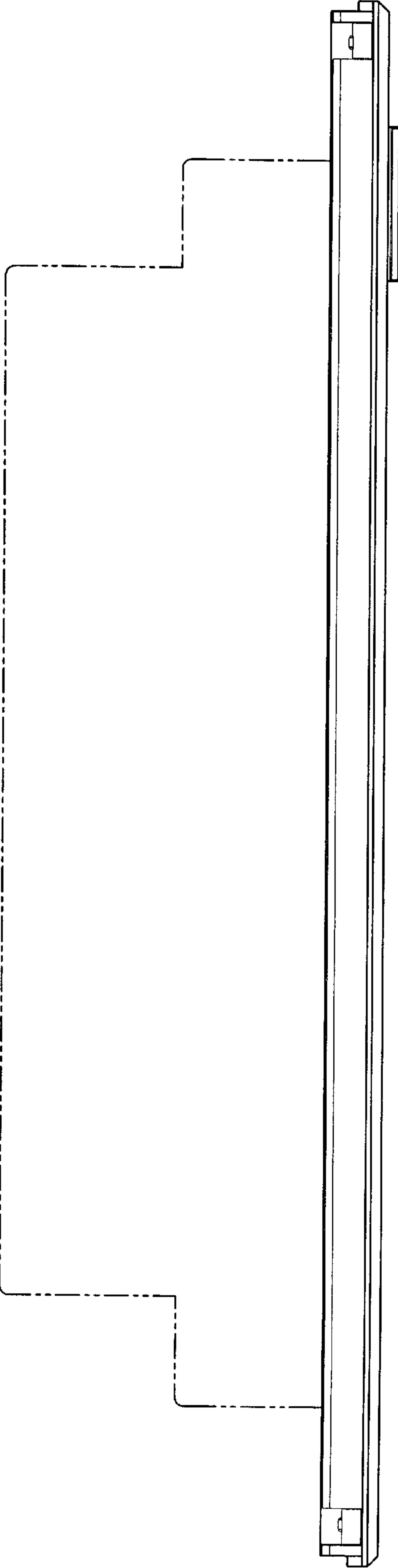

FIG. 4

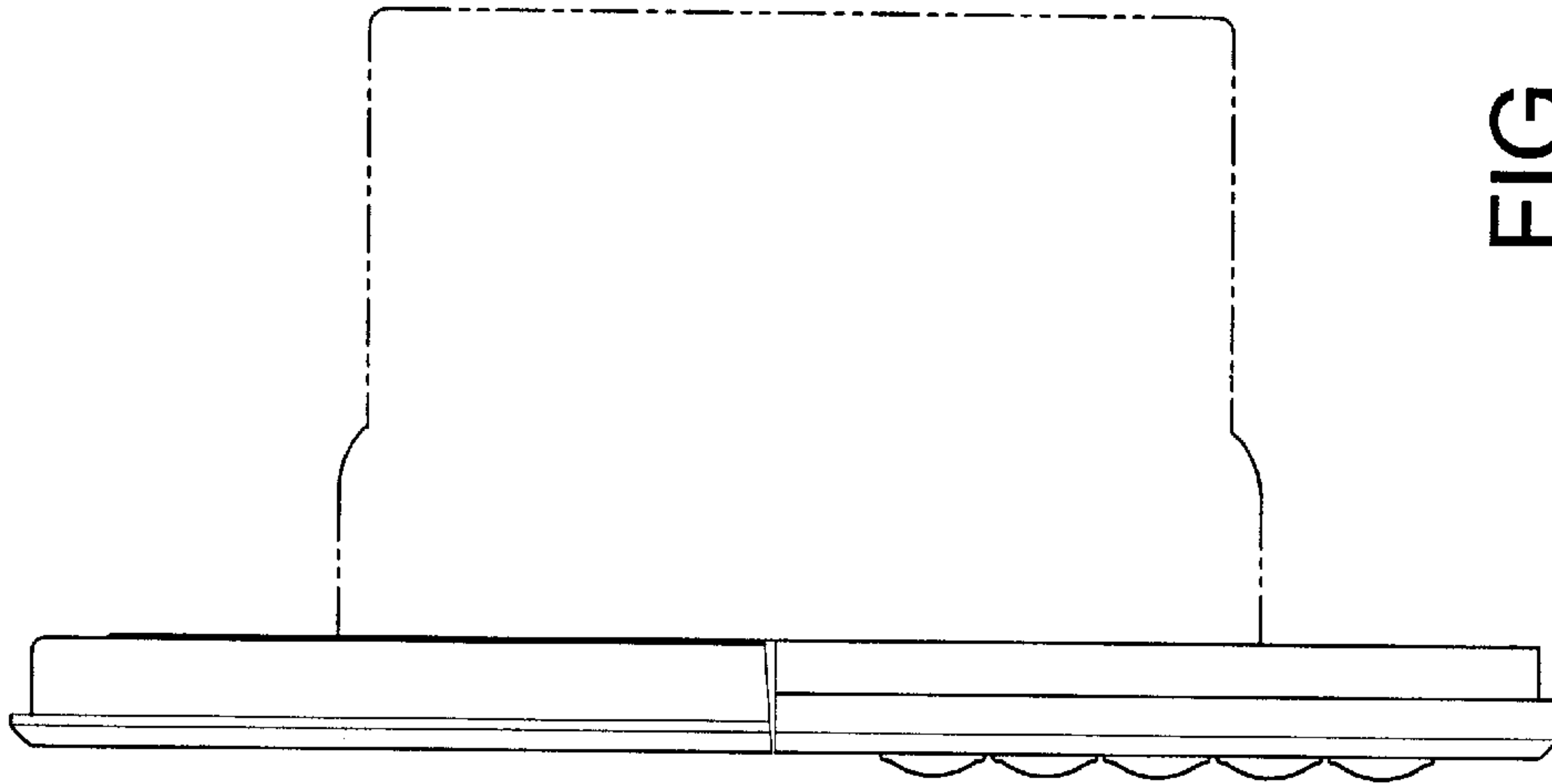

FIG. 6

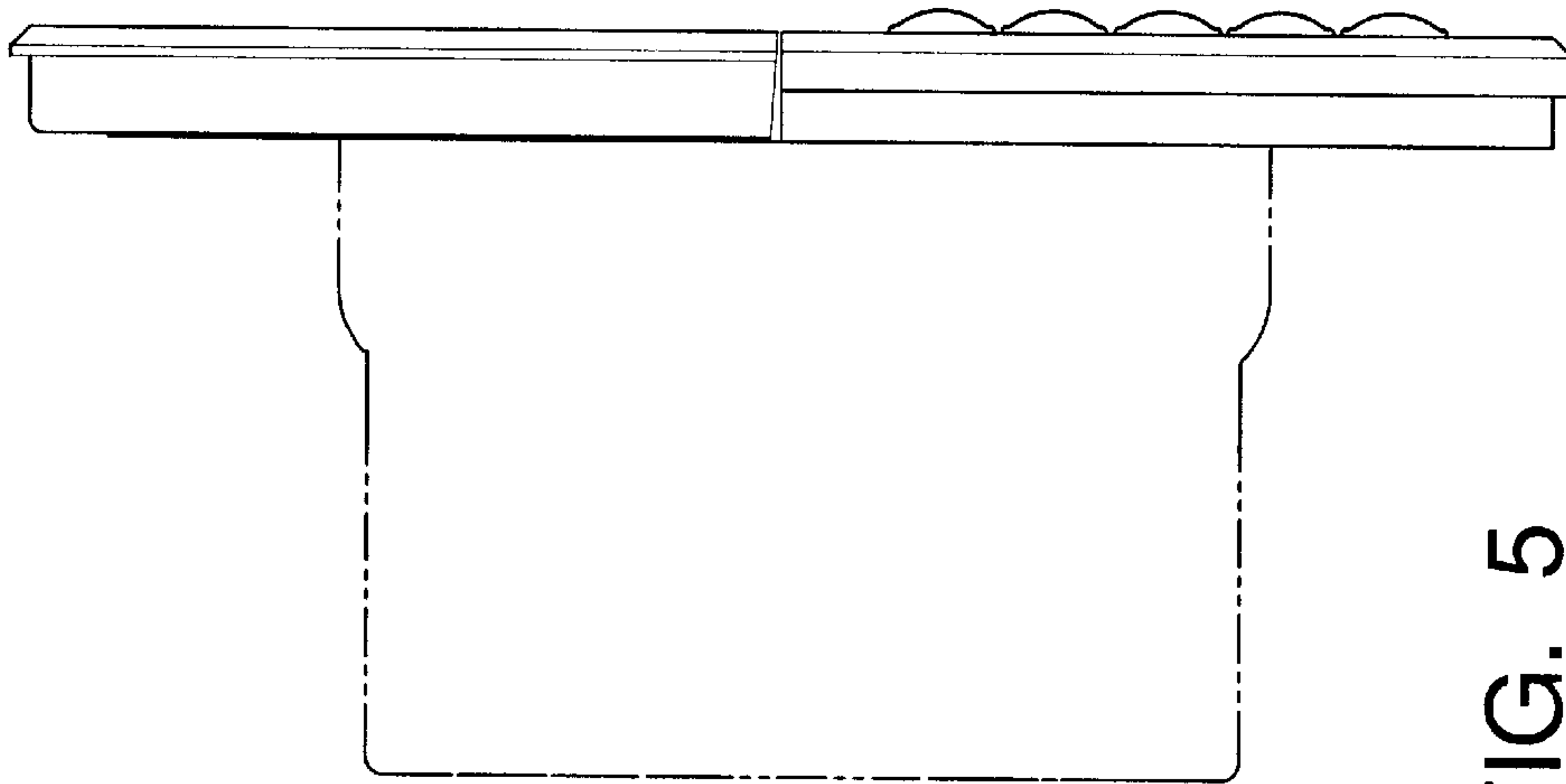

FIG. 5