



US00D515906S

(12) **United States Design Patent**
Strickland

(10) **Patent No.:** **US D515,906 S**

(45) **Date of Patent:** **** Feb. 28, 2006**

(54) **LATCH**

(75) **Inventor:** **Kenneth Strickland**, South
Glastonbury, CT (US)

(73) **Assignee:** **The Stanley Works**, New Britain, CT
(US)

(**) **Term:** **14 Years**

(21) **Appl. No.:** **29/226,392**

(22) **Filed:** **Mar. 29, 2005**

(51) **LOC (8) Cl.** **08-01**

(52) **U.S. Cl.** **D8/300**

(58) **Field of Classification Search** D8/300,
D8/307, 310, 311, 313, 314-316, 319-321,
D8/336, 338, DIG. 1, DIG. 2, DIG. 16, DIG. 30;
16/110.1, DIG. 30

See application file for complete search history.

(56) **References Cited**

U.S. PATENT DOCUMENTS

- D105,648 S * 8/1937 Carruthers D8/341
- D171,485 S * 2/1954 Borchers D8/341
- D214,359 S * 6/1969 De Lee D8/341

- D436,830 S * 1/2001 Nesselth D8/302
- D494,834 S * 8/2004 Etlicher D8/302
- 6,868,703 B2 * 3/2005 Molzer 70/210

* cited by examiner

Primary Examiner—Prabhakar Deshmukh

Assistant Examiner—Jean E. McCormick

(74) *Attorney, Agent, or Firm*—Pillsbury Winthrop Shaw
Pittman LLP

(57) **CLAIM**

The ornamental design for a latch, as shown and described.

DESCRIPTION

FIG. 1 is a left side perspective view of a latch showing my new design;
 FIG. 2 is a rear view thereof;
 FIG. 3 is a front view thereof;
 FIG. 4 is a left side view thereof;
 FIG. 5 is a right side view thereof;
 FIG. 6 is a top view thereof;
 FIG. 7 is a bottom side view thereof;
 FIG. 8 is a right side perspective view thereof; and,
 FIG. 9 is a top perspective view thereof.

1 Claim, 6 Drawing Sheets

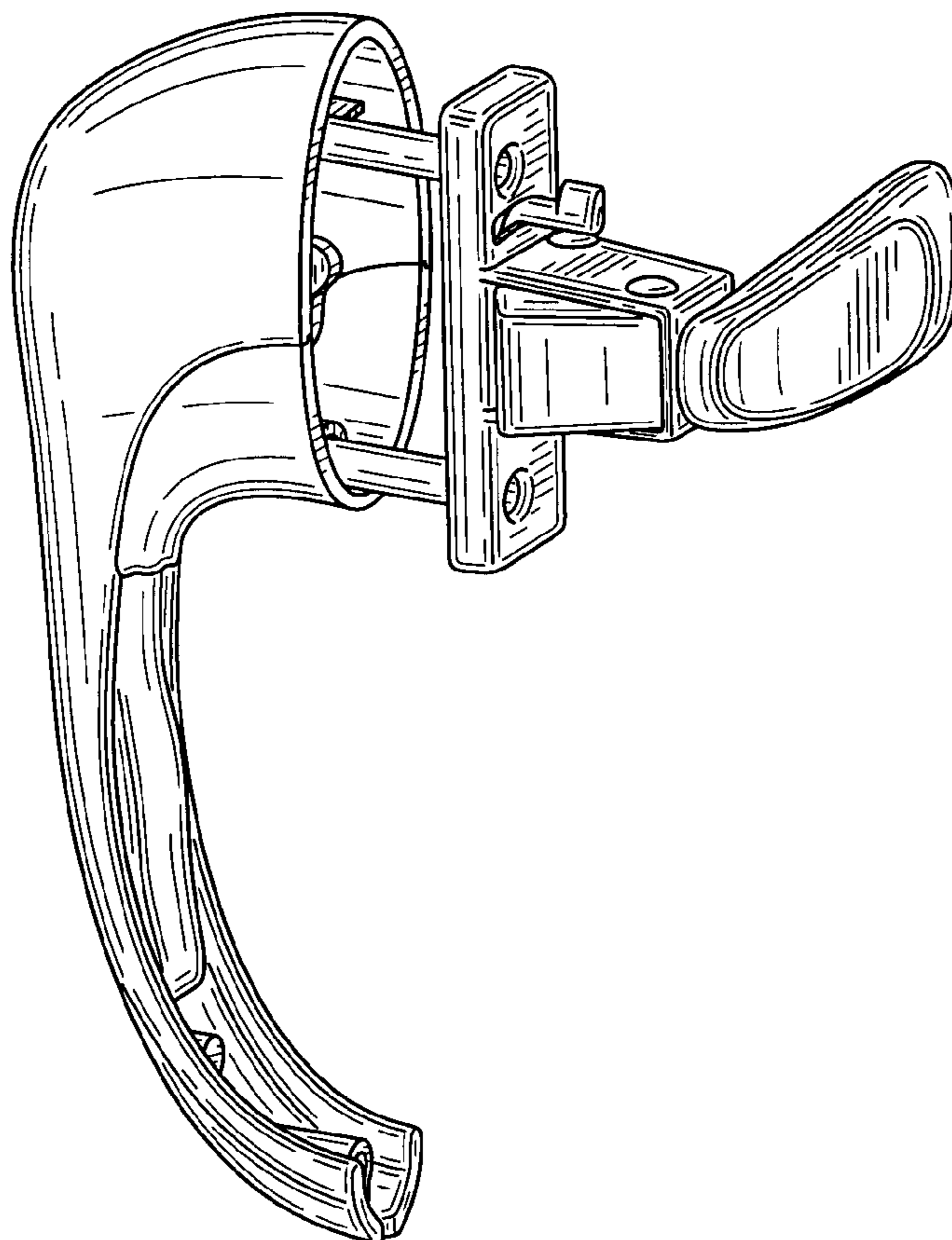

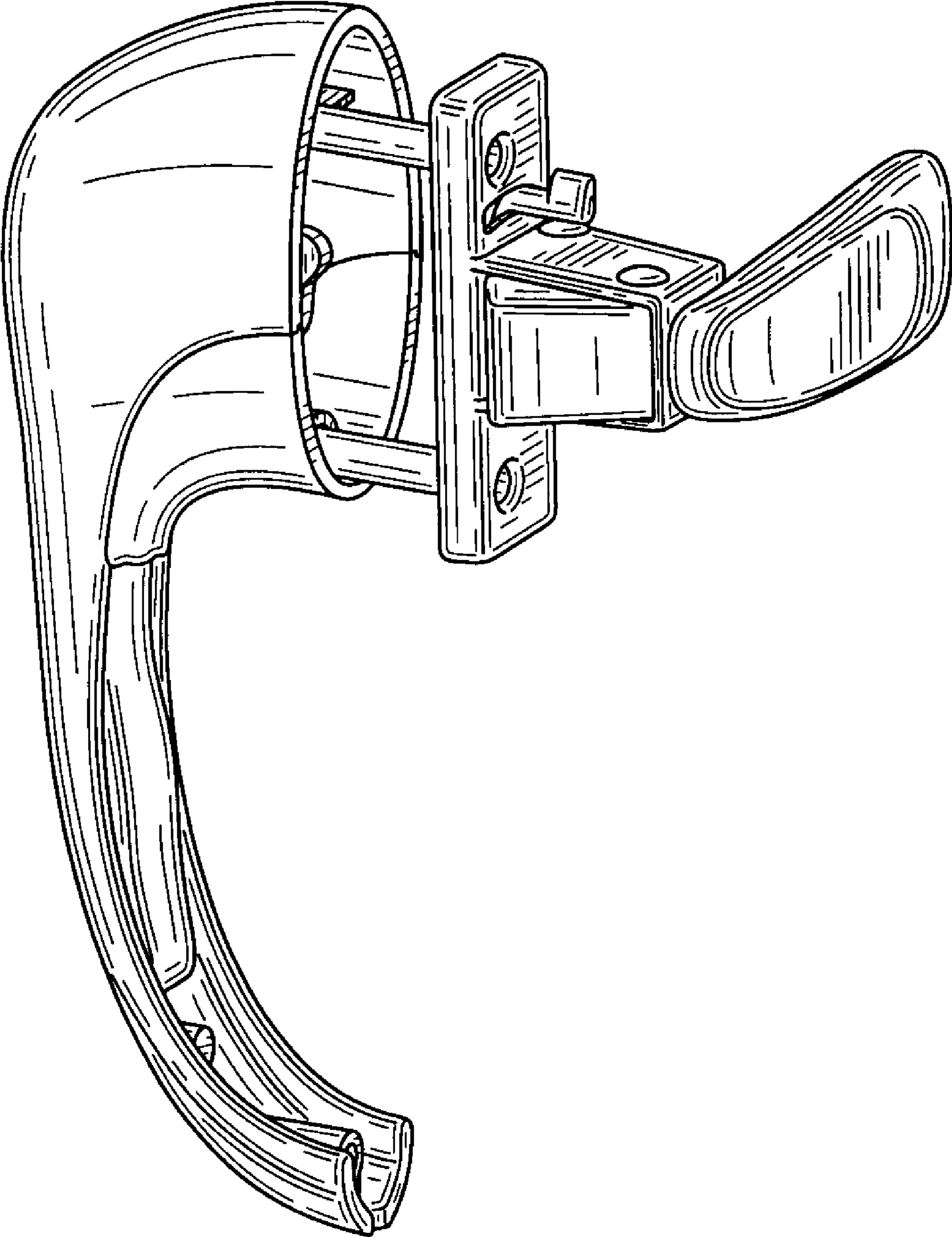

FIG. 1

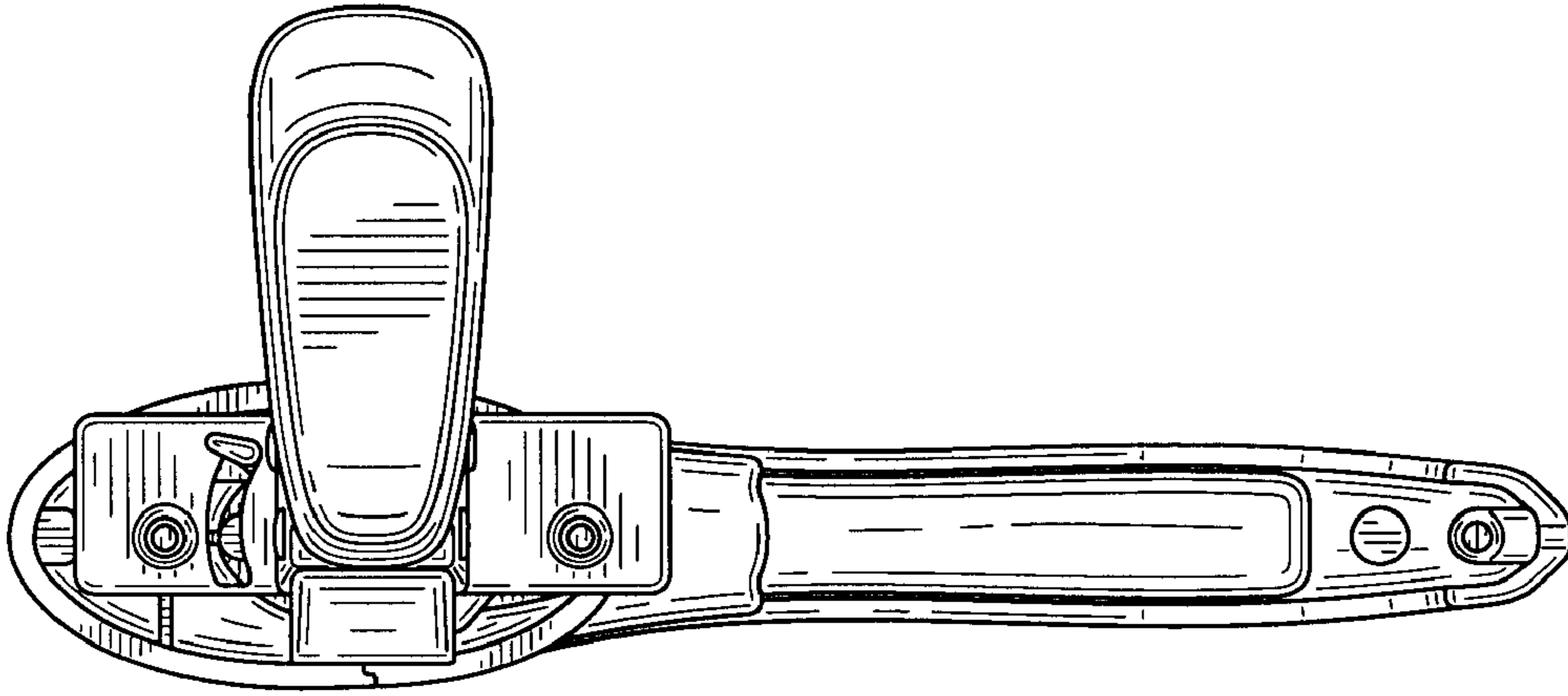

FIG. 3

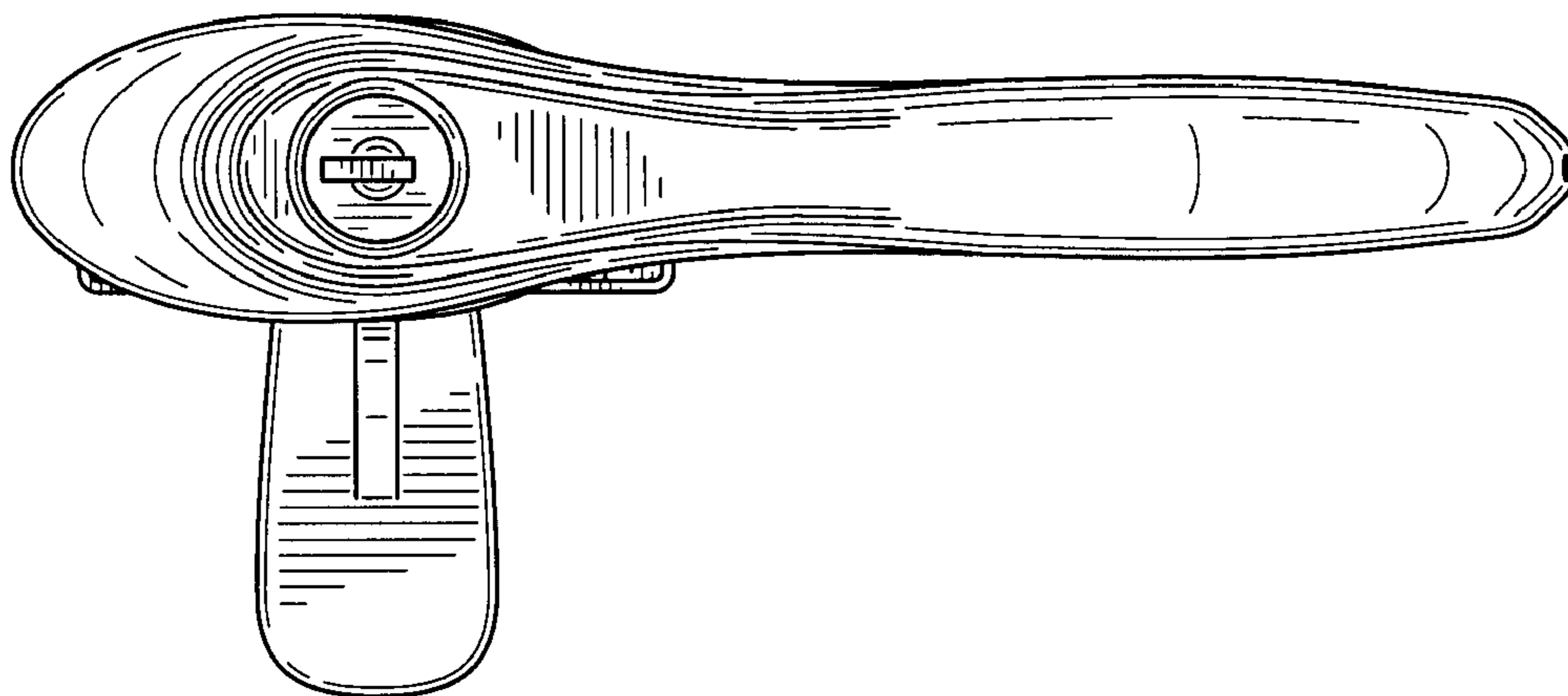

FIG. 2

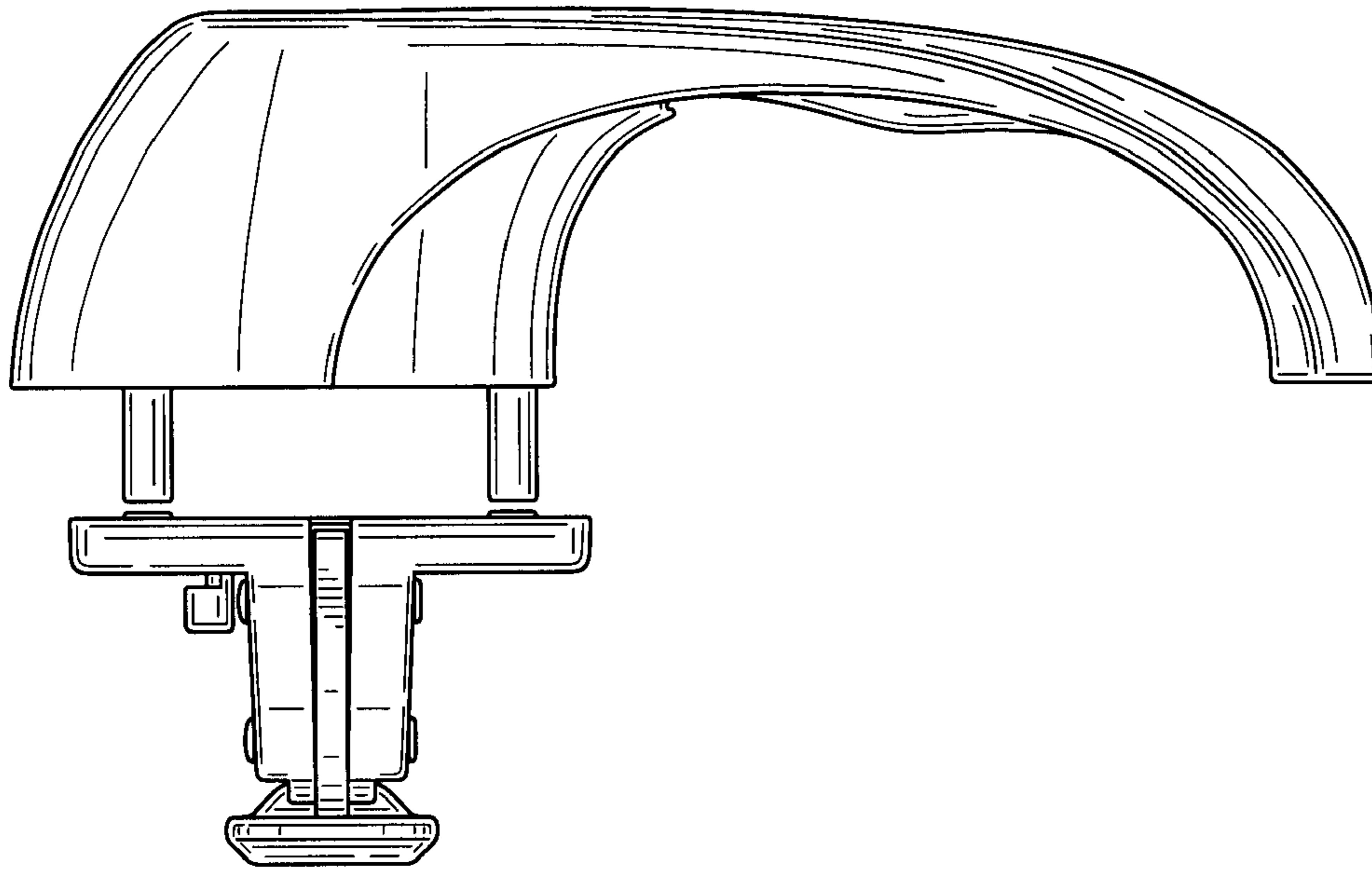

FIG. 5

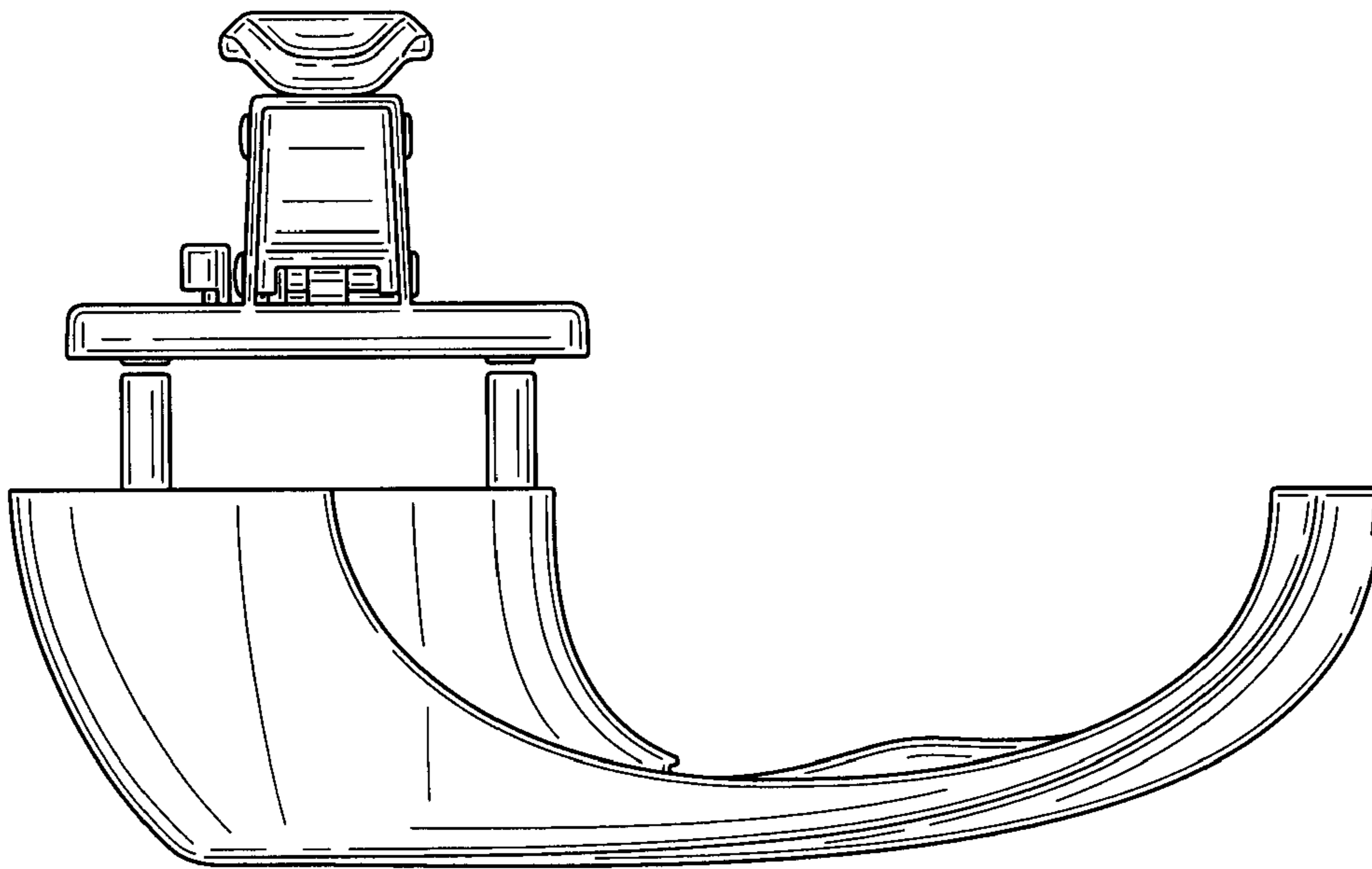

FIG. 4

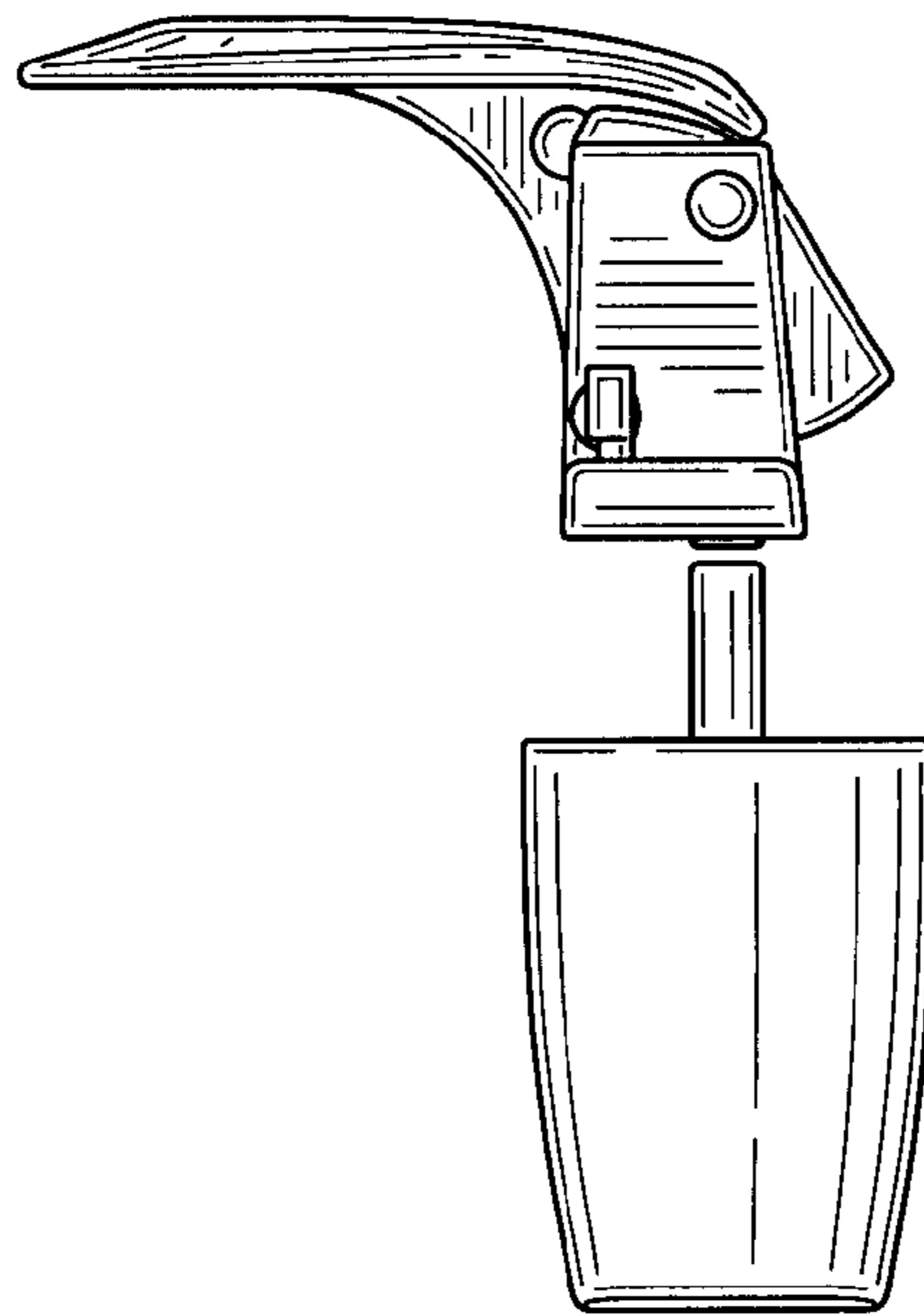

FIG. 6

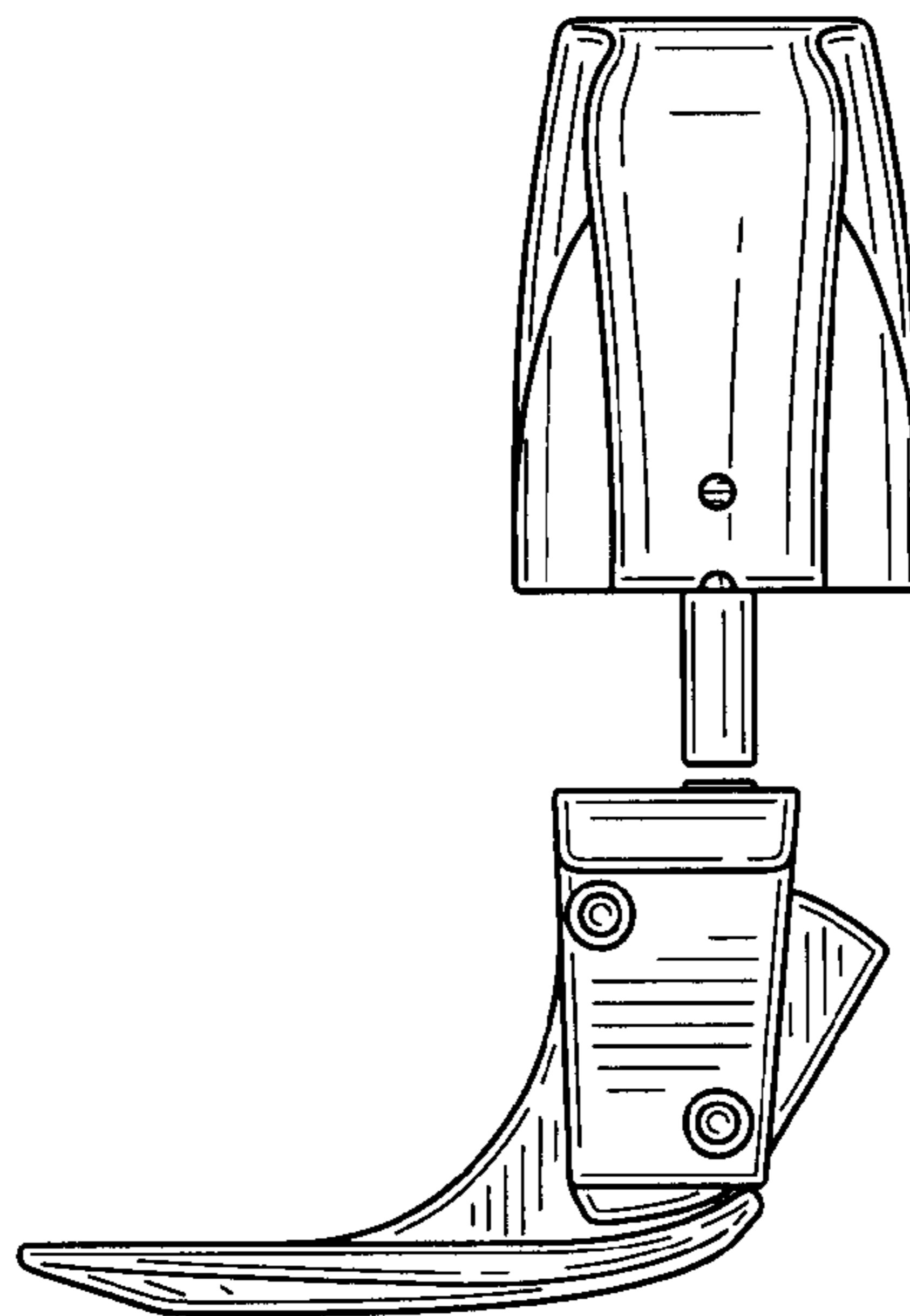

FIG. 7

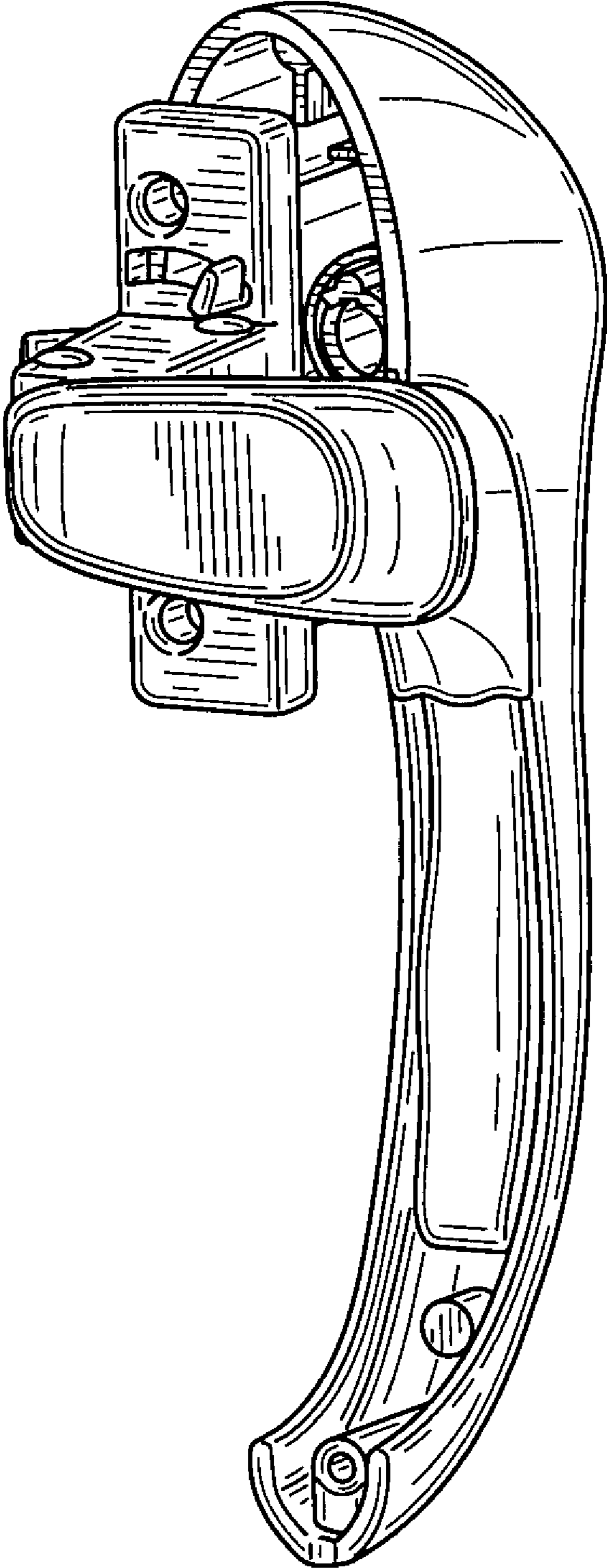

FIG. 8

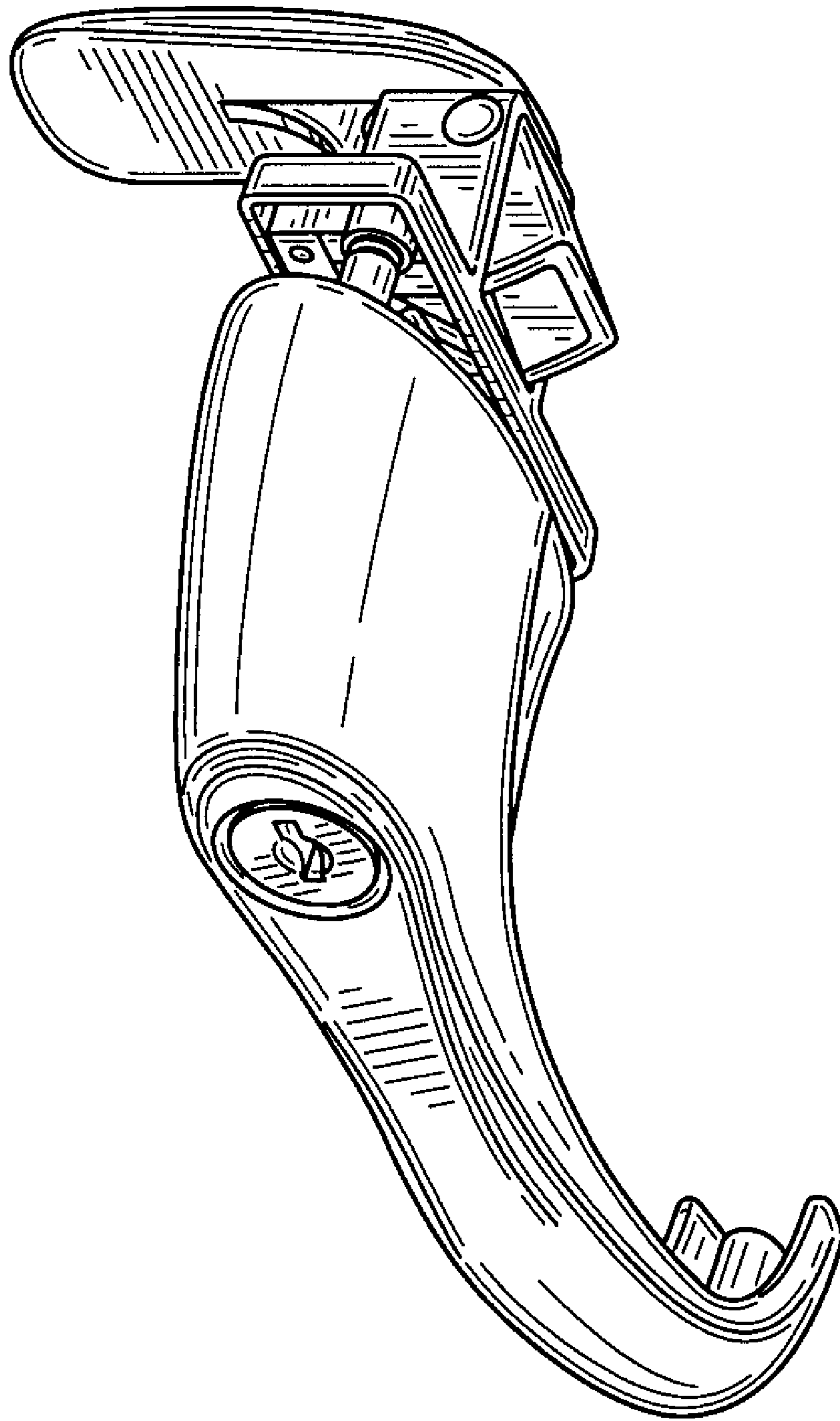

FIG. 9