

US00D515902S

(12) **United States Design Patent**
Kim

(10) **Patent No.:** **US D515,902 S**
(45) **Date of Patent:** **** Feb. 28, 2006**

(54) **DIRECTIONAL COMPASS, EMERGENCY TOOL AND SCRATCH PROTECTOR**

D494,696 S * 8/2004 Kim D26/49

FOREIGN PATENT DOCUMENTS

(76) Inventor: **Tae Hyung Kim**, 2-702 sambo mansion, 580-4 yun san 1 dong, yun jae-ku, Busan (KR)

KR 1042 5/1992

* cited by examiner

(**) Term: **14 Years**

Primary Examiner—Cathron C. Brooks

Assistant Examiner—Austin Murphy

(74) *Attorney, Agent, or Firm*—Jacobson Holman PLLC

(21) Appl. No.: **29/202,661**

(22) Filed: **Apr. 5, 2004**

(57) **CLAIM**

(51) **LOC (8) Cl.** **08-05**

I claim the ornamental design for directional compass, emergency tool and scratch protector, as shown and described.

(52) **U.S. Cl.** **D8/105**

(58) **Field of Classification Search** D8/104, D8/105, 81, 99; D10/68; D22/117; D26/49, D26/38; D3/210; 600/200; 81/128; 7/165, 7/100, 138

DESCRIPTION

See application file for complete search history.

FIG. 1 is a front view of directional compass, emergency tool and scratch protector:

FIG. 2 is a directional compass, emergency tool and scratch protector shown in an alternate position of use.

FIG. 3 is a back view of directional compass, emergency tool and scratch protector:

FIG. 4 is a left side view of directional compass, emergency tool and scratch protector:

FIG. 5 is a right side view of directional compass, emergency tool and scratch protector:

FIG. 6 is a top view of directional compass, emergency tool and scratch protector; and,

FIG. 7 is a bottom view of directional compass, emergency tool and scratch protector.

(56) **References Cited**

U.S. PATENT DOCUMENTS

4,174,646	A	*	11/1979	Kotler	81/128
5,251,351	A	*	10/1993	Klotz	7/100
D360,674	S	*	7/1995	McClean	D22/117
5,429,119	A	*	7/1995	Griffin et al.	600/200
D369,082	S	*	4/1996	Fells et al.	D8/105
5,642,567	A	*	7/1997	Lin	30/366
D403,452	S		12/1998	Kim	D26/38
D420,269	S	*	2/2000	Ben-Moshe	D8/81
6,574,816	B2	*	6/2003	Yu Chen	7/100
D476,874	S		7/2003	Kim	D8/81
D490,551	S		5/2004	Kim	D26/38

1 Claim, 2 Drawing Sheets

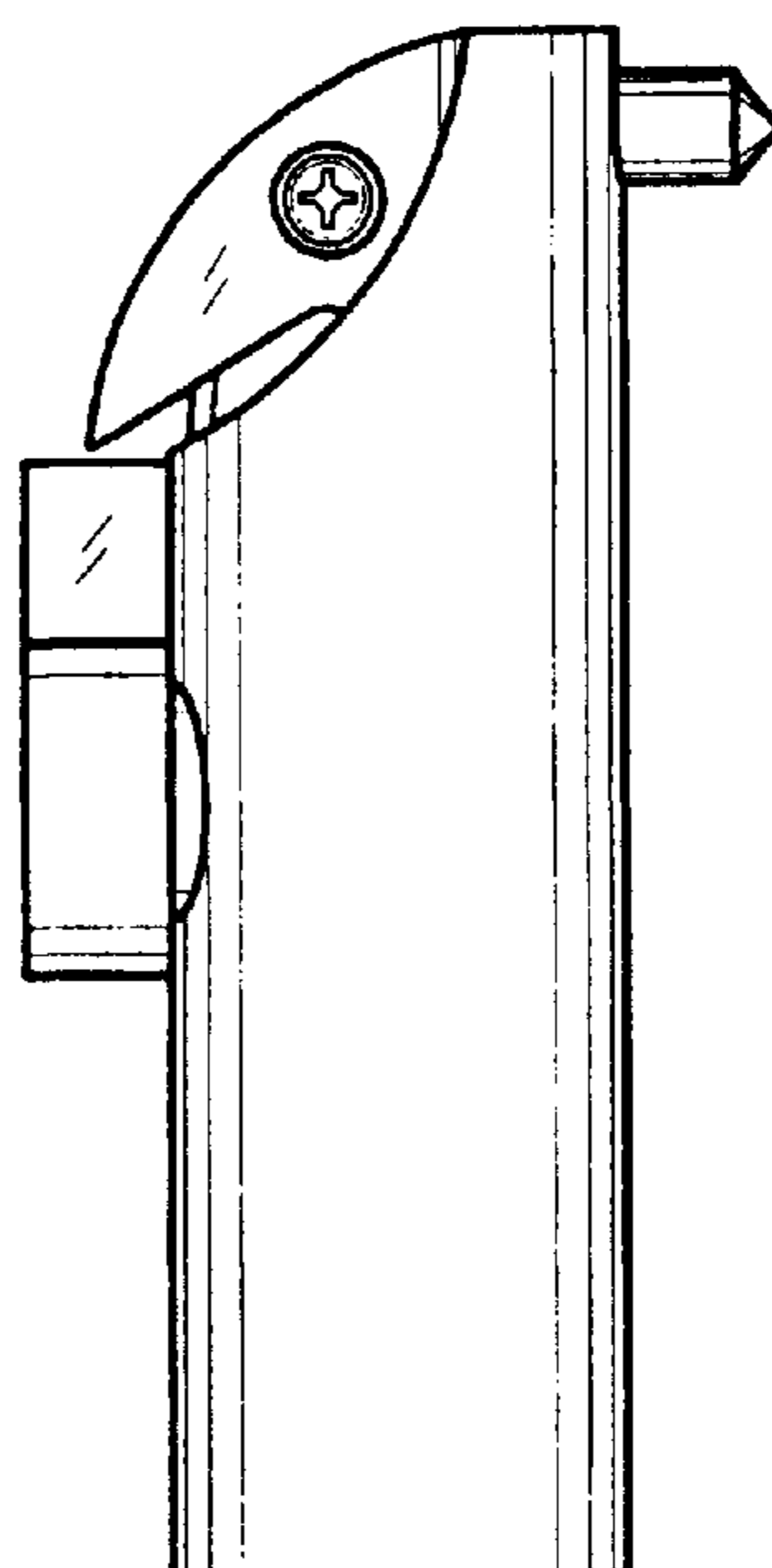

FIG.1

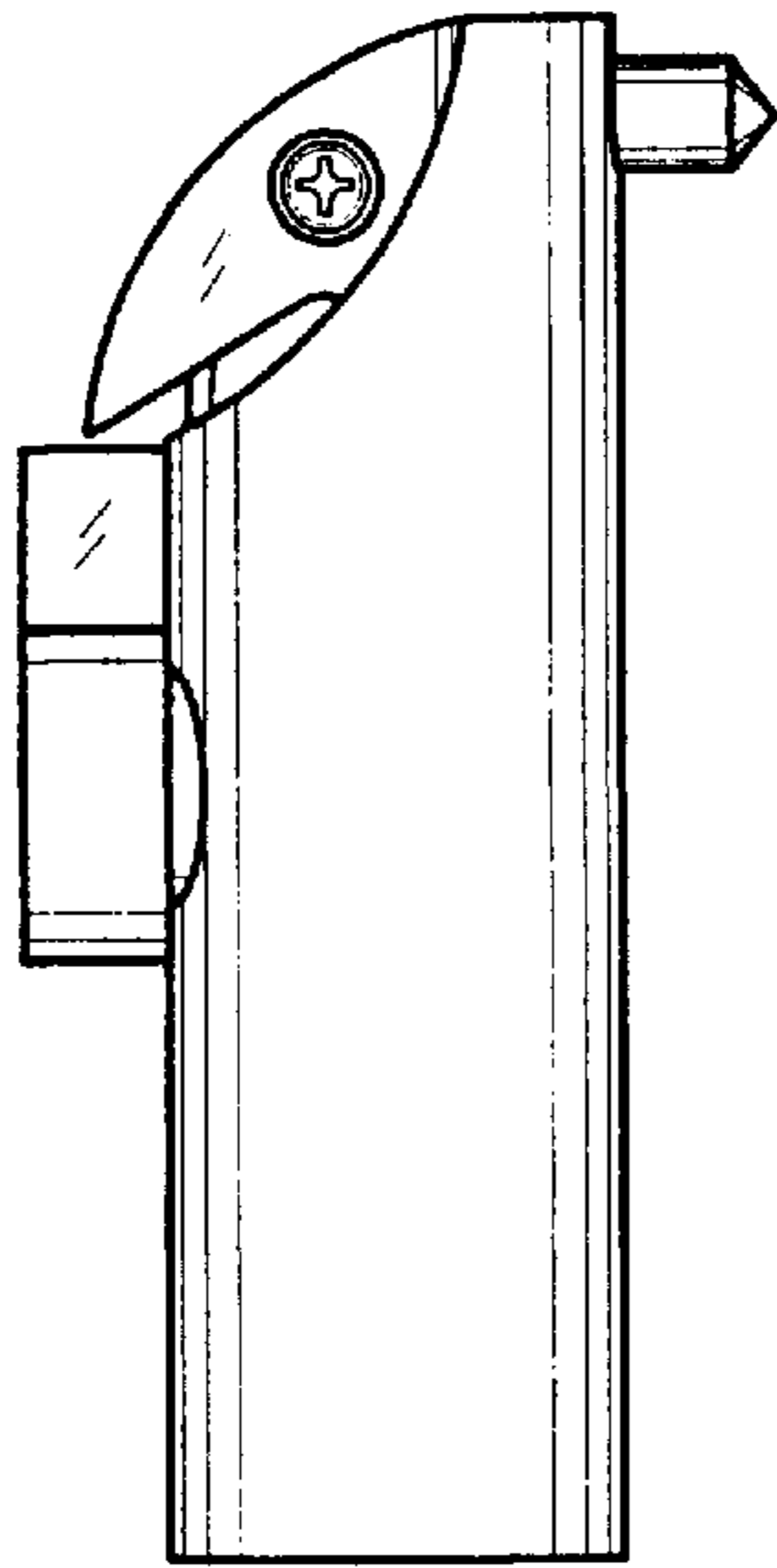

FIG.2

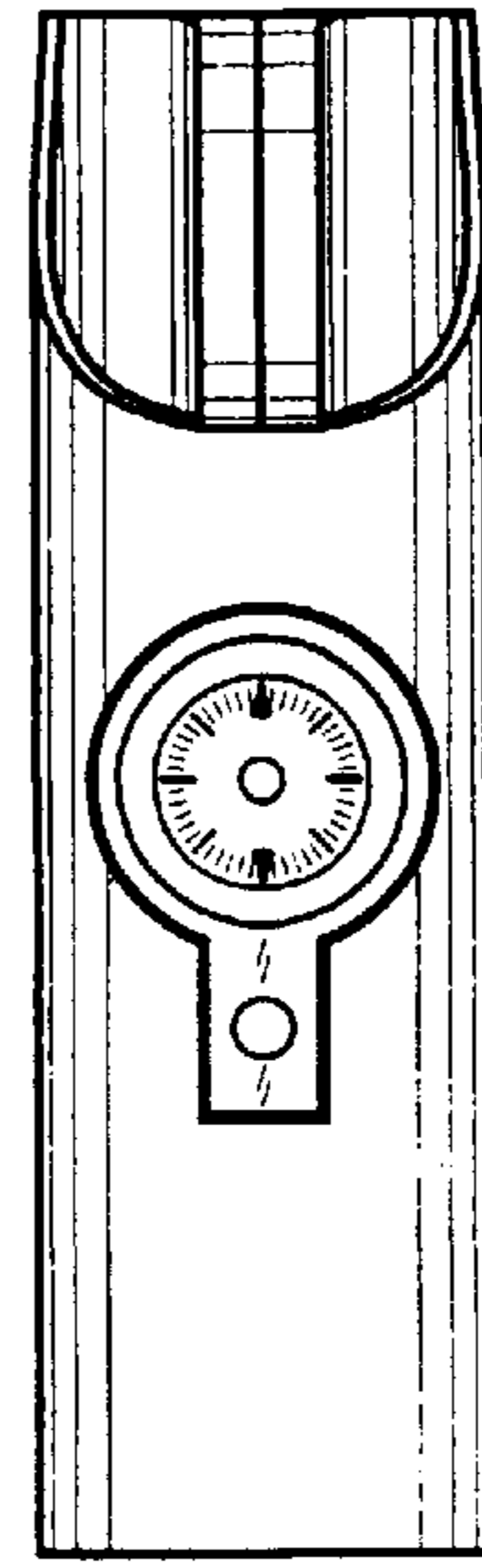

FIG.3

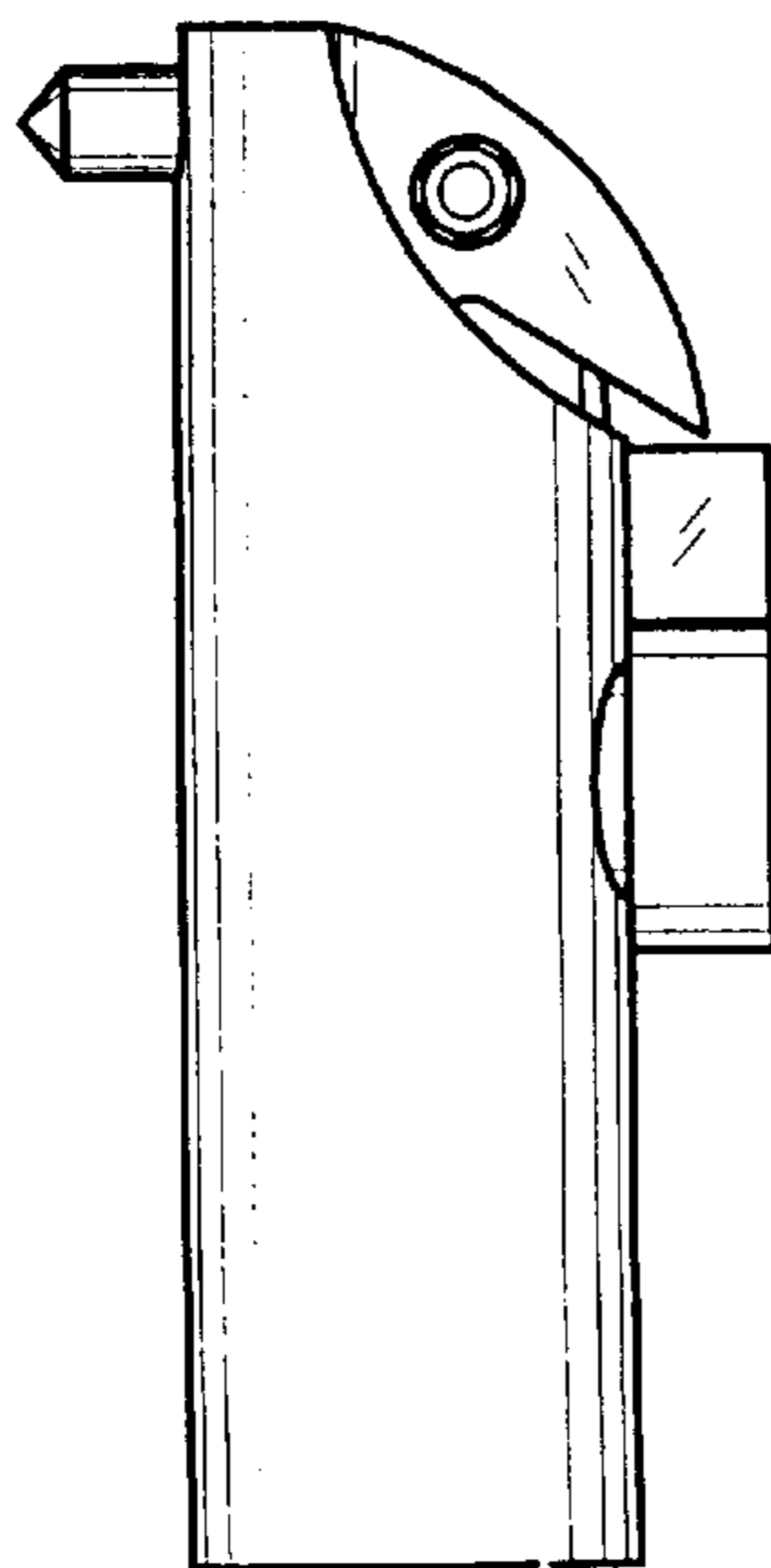

FIG.4

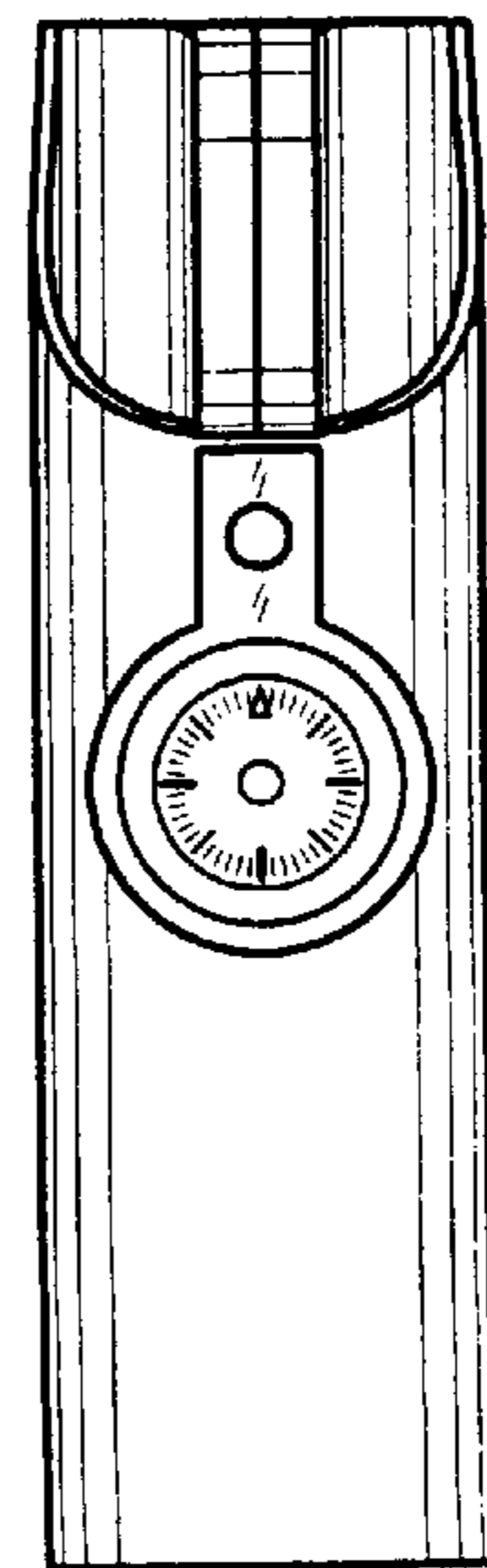

FIG.5

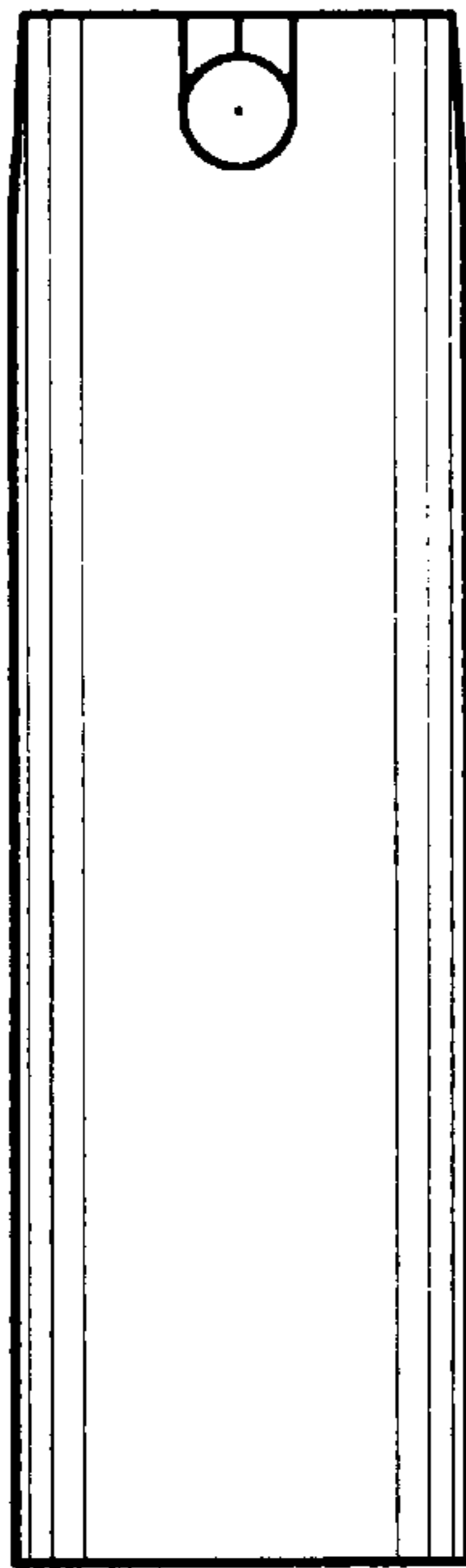

FIG.6

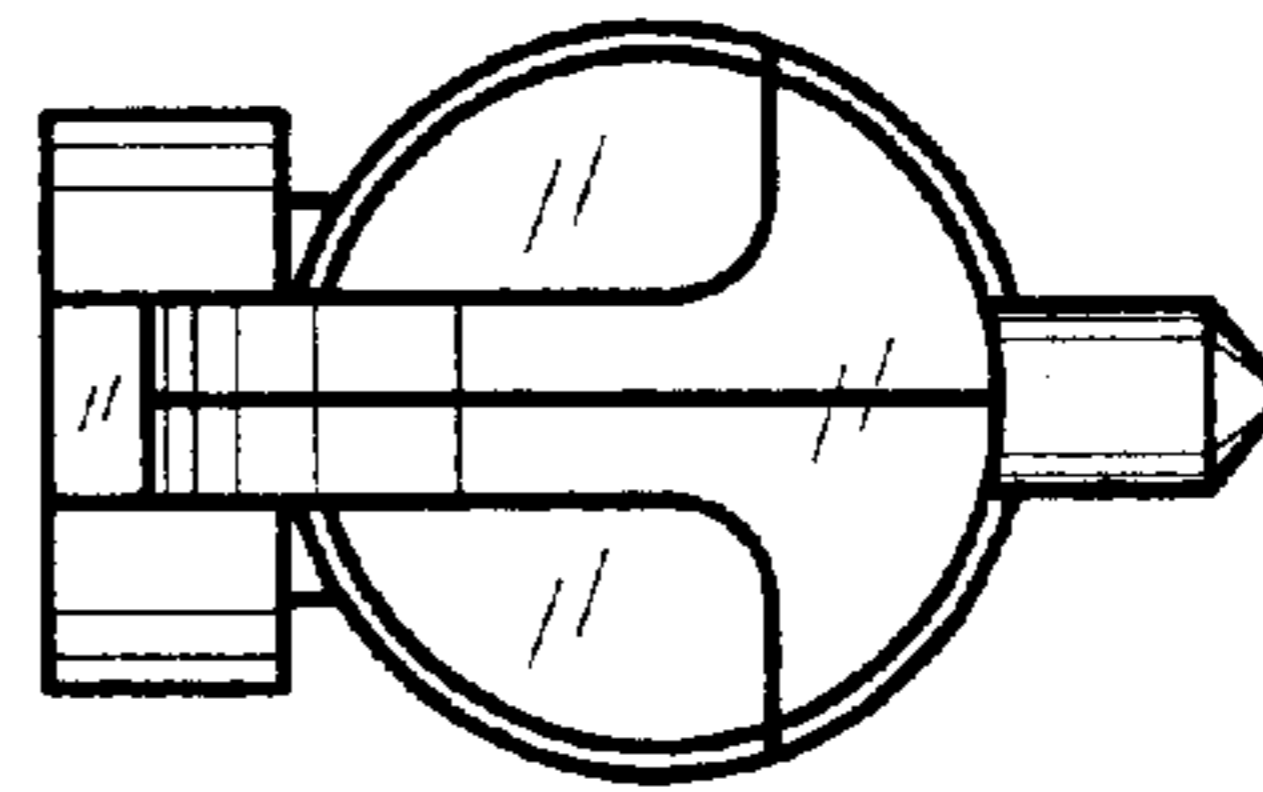

FIG.7

