



US00D515883S

(12) **United States Design Patent**
Greiner

(10) **Patent No.:** **US D515,883 S**
(45) **Date of Patent:** **** Feb. 28, 2006**

(54) **CHOPPING DEVICE**

DESCRIPTION

- (75) Inventor: **Ulrich Greiner**, Langenau (DE)
- (73) Assignee: **MOHA Moderne Haushaltwaren AG**,
Zollikofen (CH)
- (**) Term: **14 Years**
- (21) Appl. No.: **29/212,027**
- (22) Filed: **Aug. 25, 2004**
- (51) **LOC (8) Cl.** **07-04**
- (52) **U.S. Cl.** **D7/693**
- (58) **Field of Classification Search** D7/669,
D7/372, 381, 693, 412; 99/337, 645; 241/100,
241/168, 169, 169.1, 270, 272
See application file for complete search history.

FIG. 1 is a front perspective view of a chopping device with a bottom cup attached to a lower portion of the chopping device, according to one embodiment of this invention;
 FIG. 2 is a front view of the chopping device, as shown in FIG. 1;
 FIG. 3 is a side view of the chopping device, as shown in FIG. 1;
 FIG. 4 is a side view, opposite the side view shown in FIG. 3, of the chopping device, as shown in FIG. 1;
 FIG. 5 is a rear view of the chopping device, as shown in FIG. 1;
 FIG. 6 is a top view of the chopping device, as shown in FIG. 1;
 FIG. 7 is a bottom view of the chopping device, as shown in FIG. 1;
 FIG. 8 is a front perspective view of a chopping device without a bottom cover on a lower portion of the chopping device, according to another embodiment of this invention;
 FIG. 9 is a front view of the chopping device, as shown in FIG. 8;
 FIG. 10 is a side view of the chopping device, as shown in FIG. 8;
 FIG. 11 is a side view, opposite the side view shown in FIG. 10, of the chopping device, as shown in FIG. 8;
 FIG. 12 is a rear view of the chopping device, as shown in FIG. 8;
 FIG. 13 is a top view of the chopping device, as shown in FIG. 8; and,
 FIG. 14 is a bottom view of the chopping device, as shown in FIG. 8.

(56) **References Cited**

U.S. PATENT DOCUMENTS

- 4,967,970 A * 11/1990 Michel 241/169
- D331,170 S * 11/1992 Greiner D7/693
- 5,632,450 A * 5/1997 Moor 241/100
- 6,467,711 B2 10/2002 Michel
- D481,271 S 10/2003 Herren
- D489,585 S * 5/2004 Wong D7/693

* cited by examiner

Primary Examiner—Terry A. Wallace

(74) *Attorney, Agent, or Firm*—Pauley Peterson & Erickson

(57) **CLAIM**

The ornamental design for a chopping device, as shown and described.

1 Claim, 6 Drawing Sheets

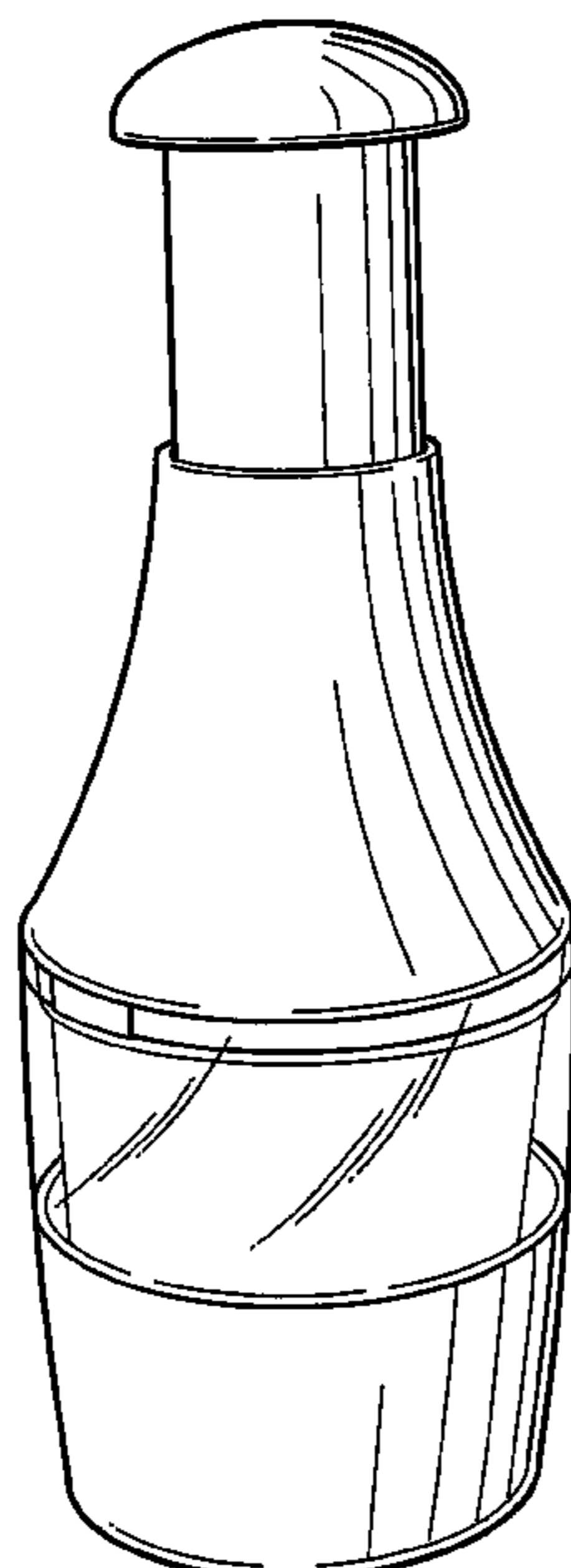

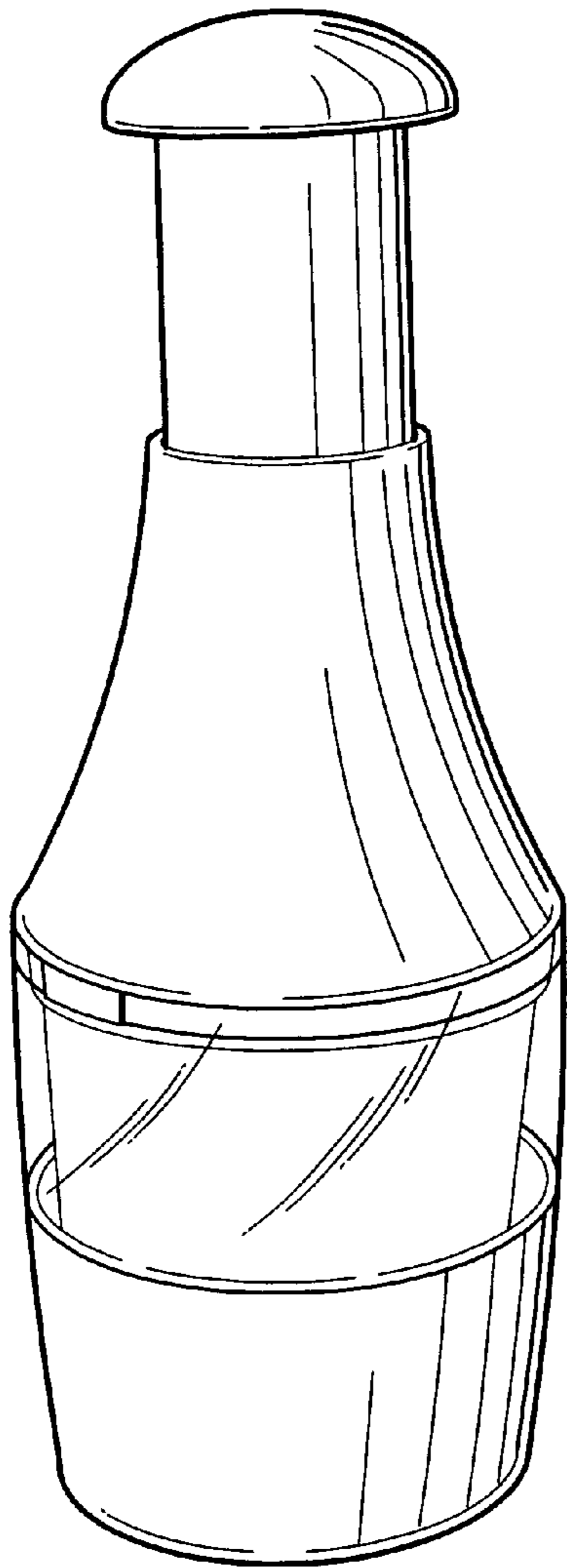

FIG. 1

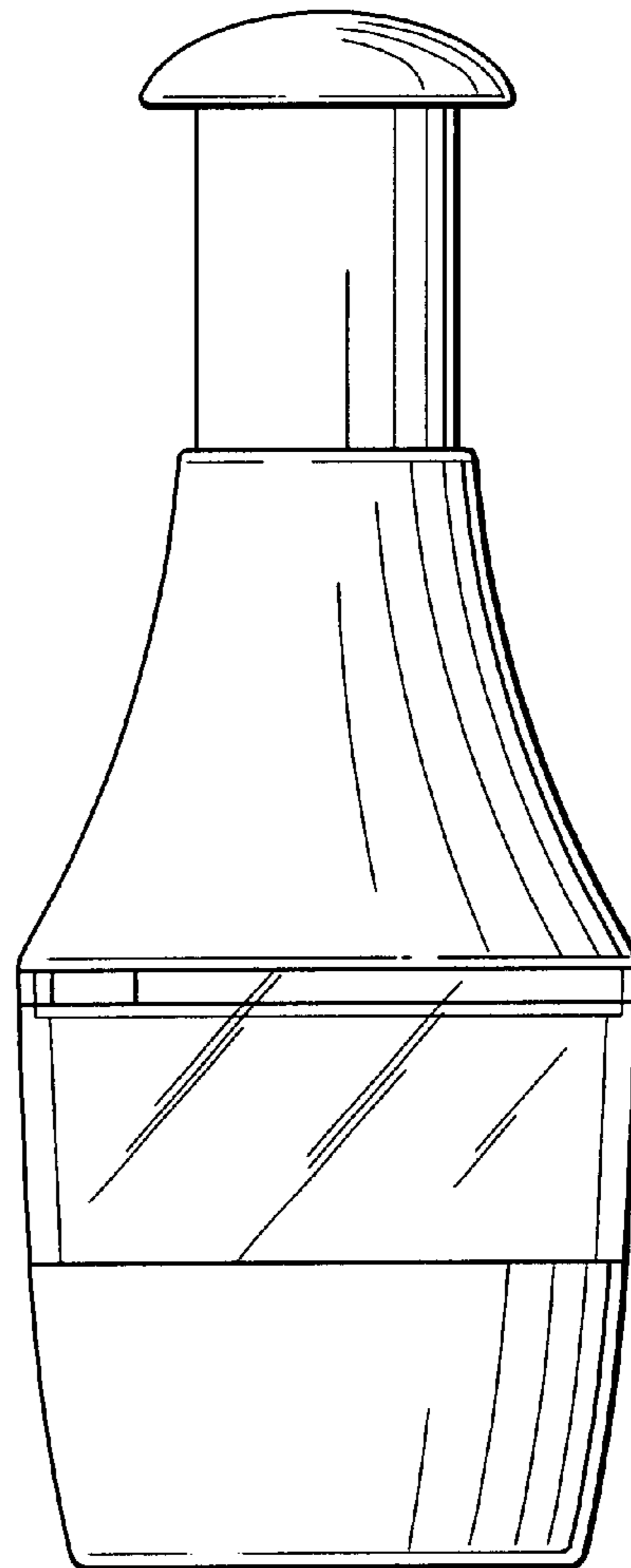

FIG. 2

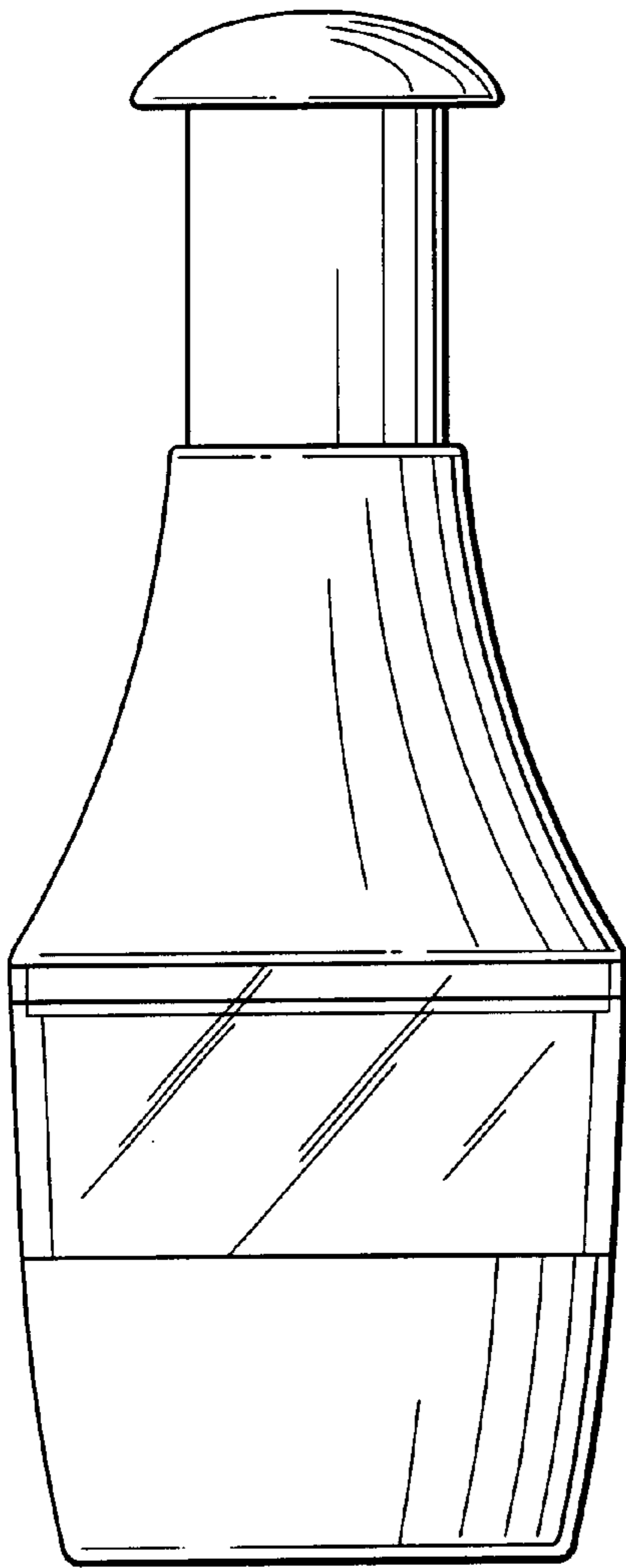

FIG. 3

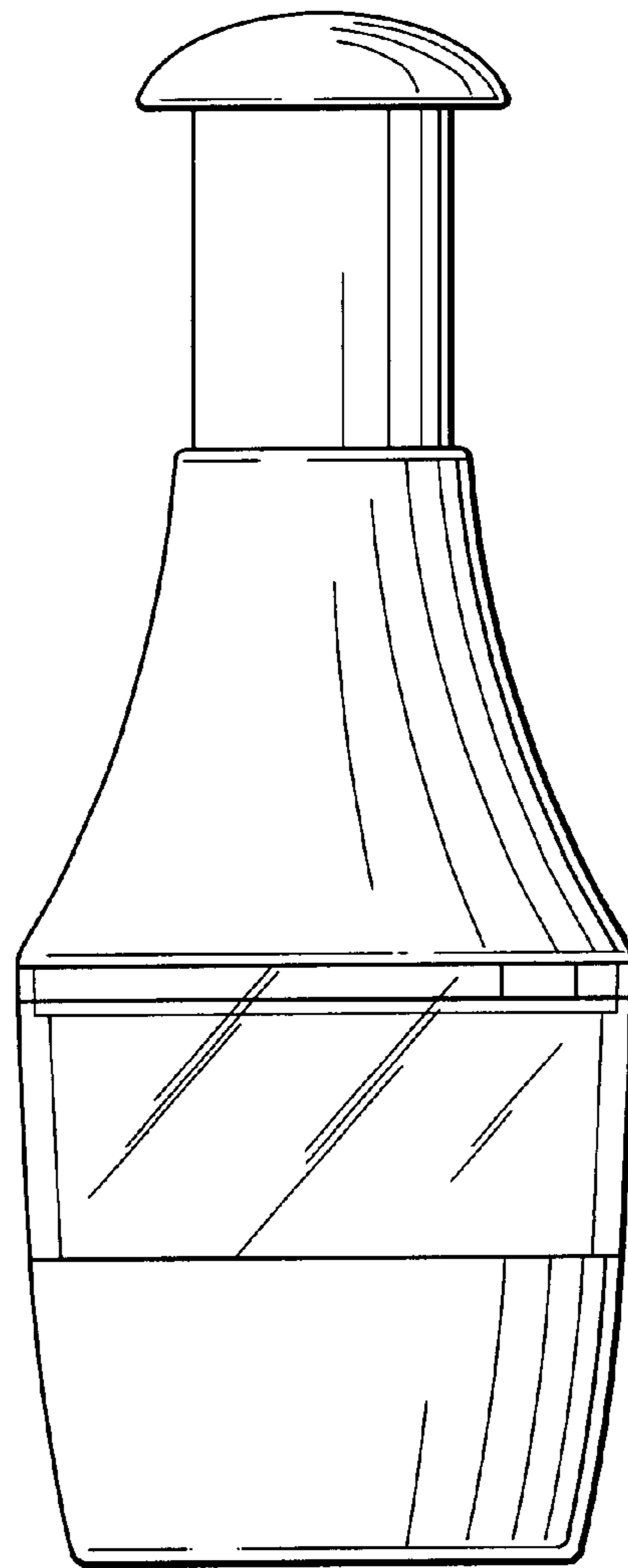

FIG. 4

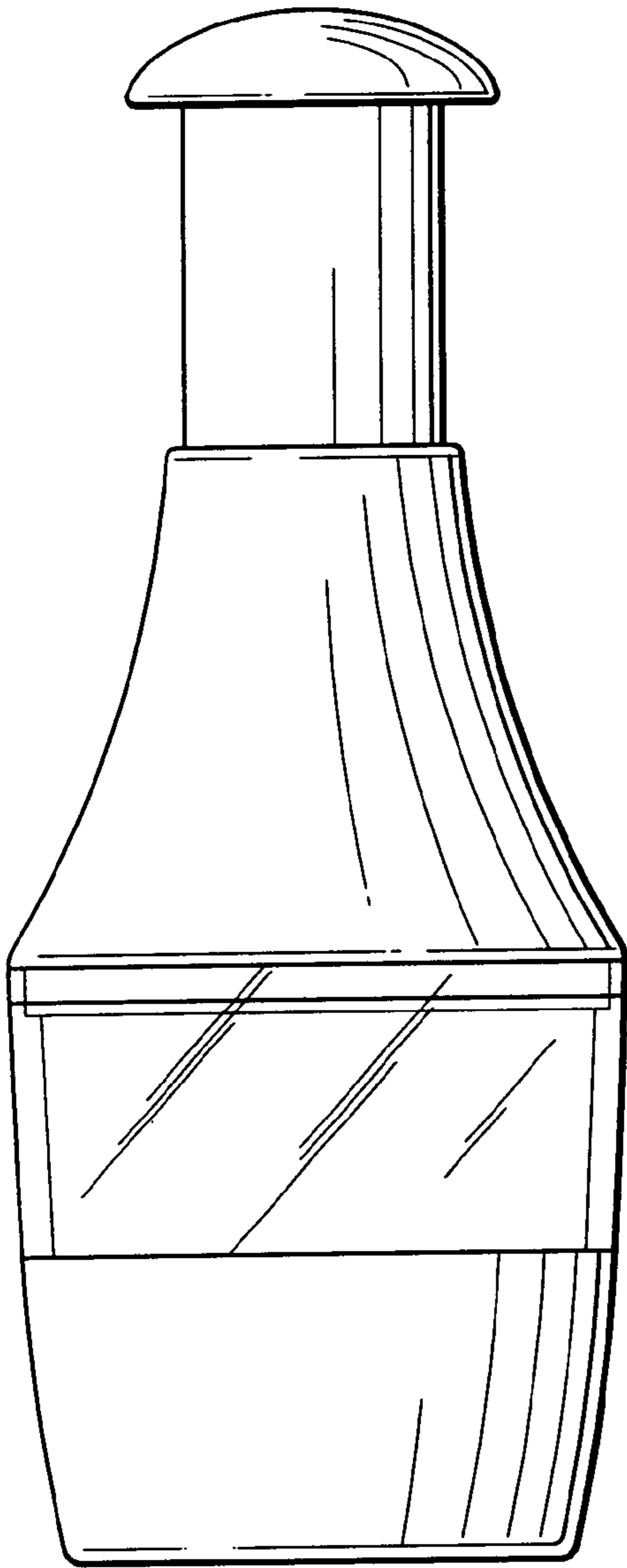

FIG. 5

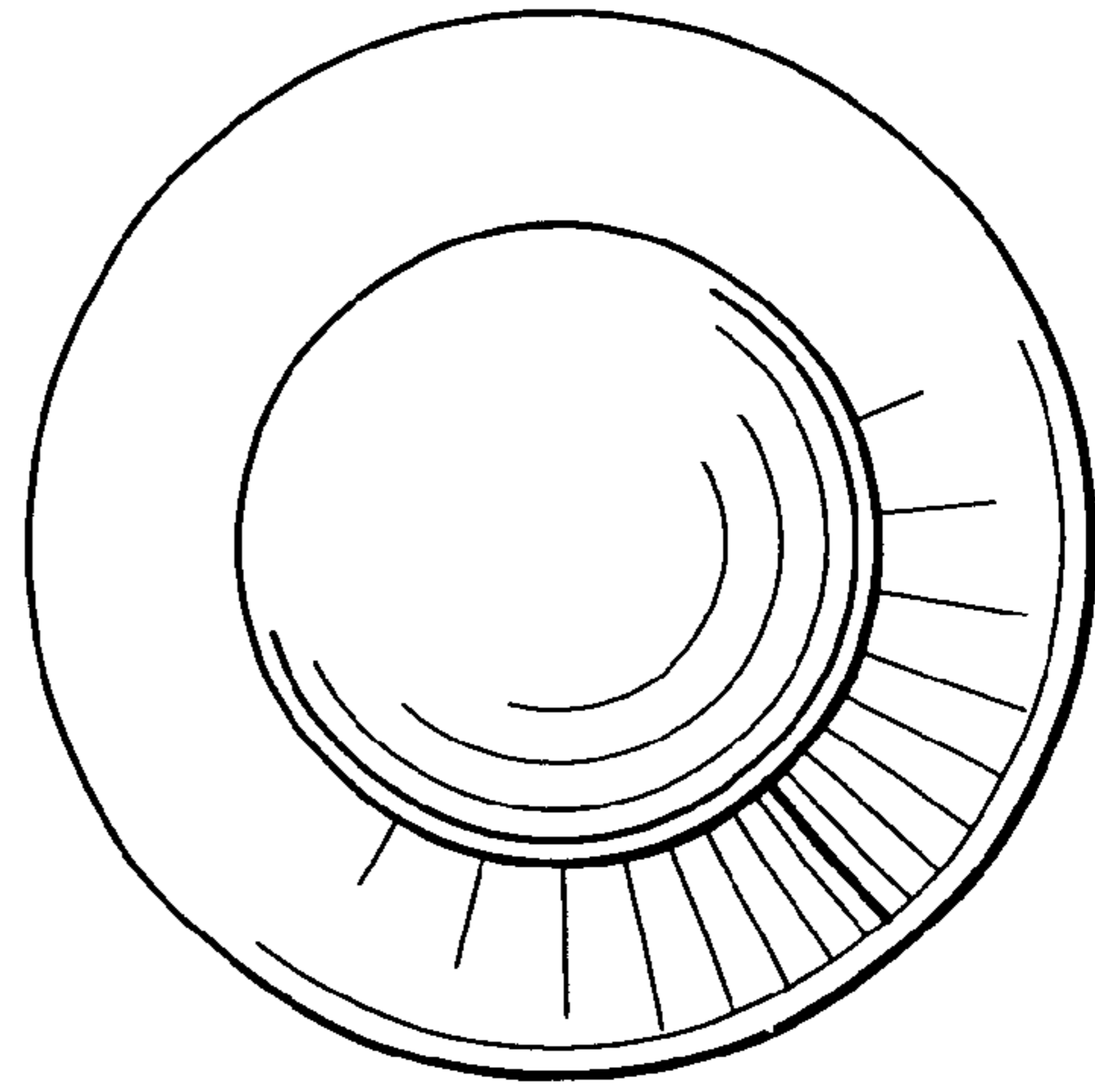

FIG. 6

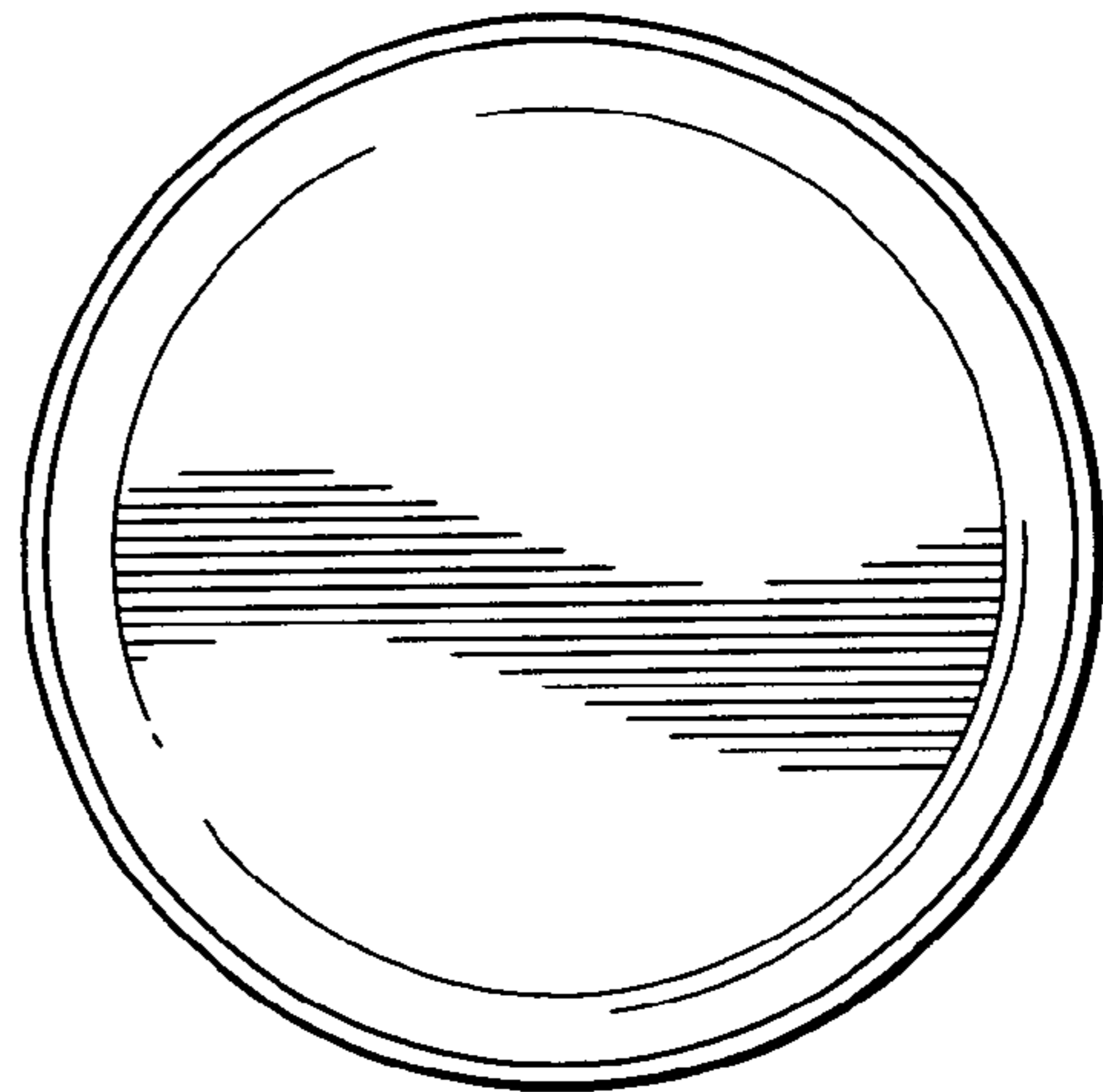

FIG. 7

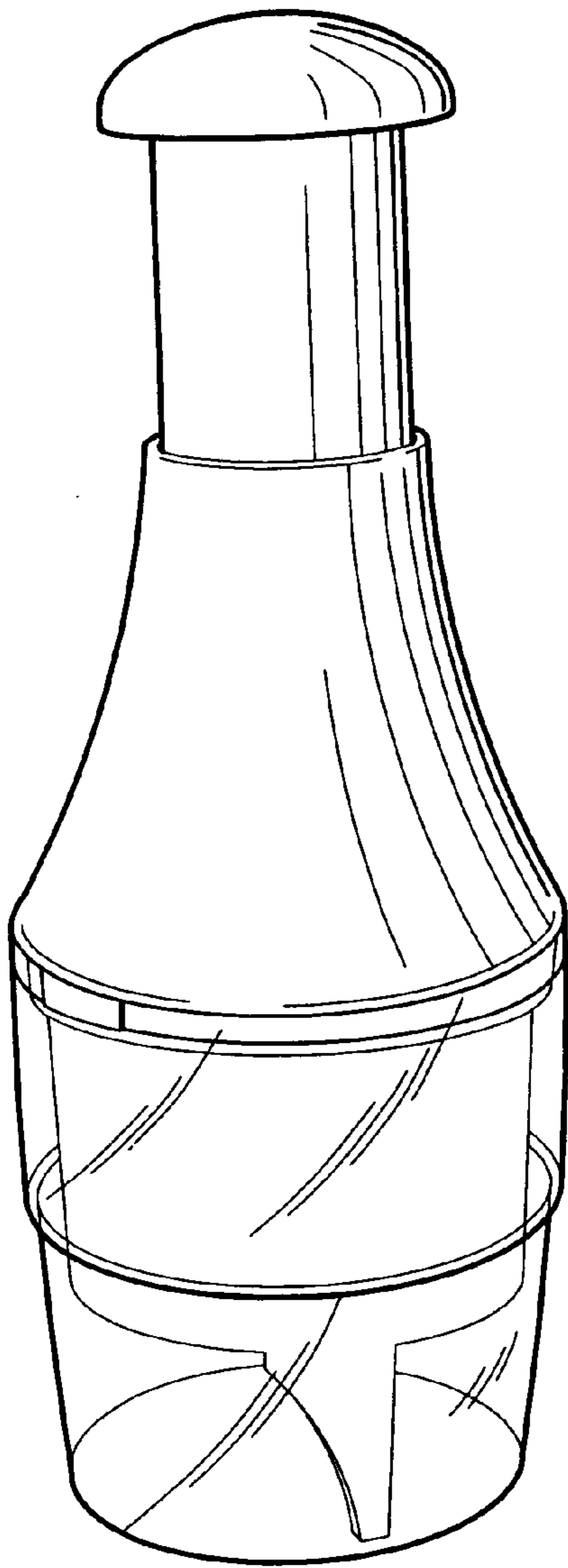

FIG. 8

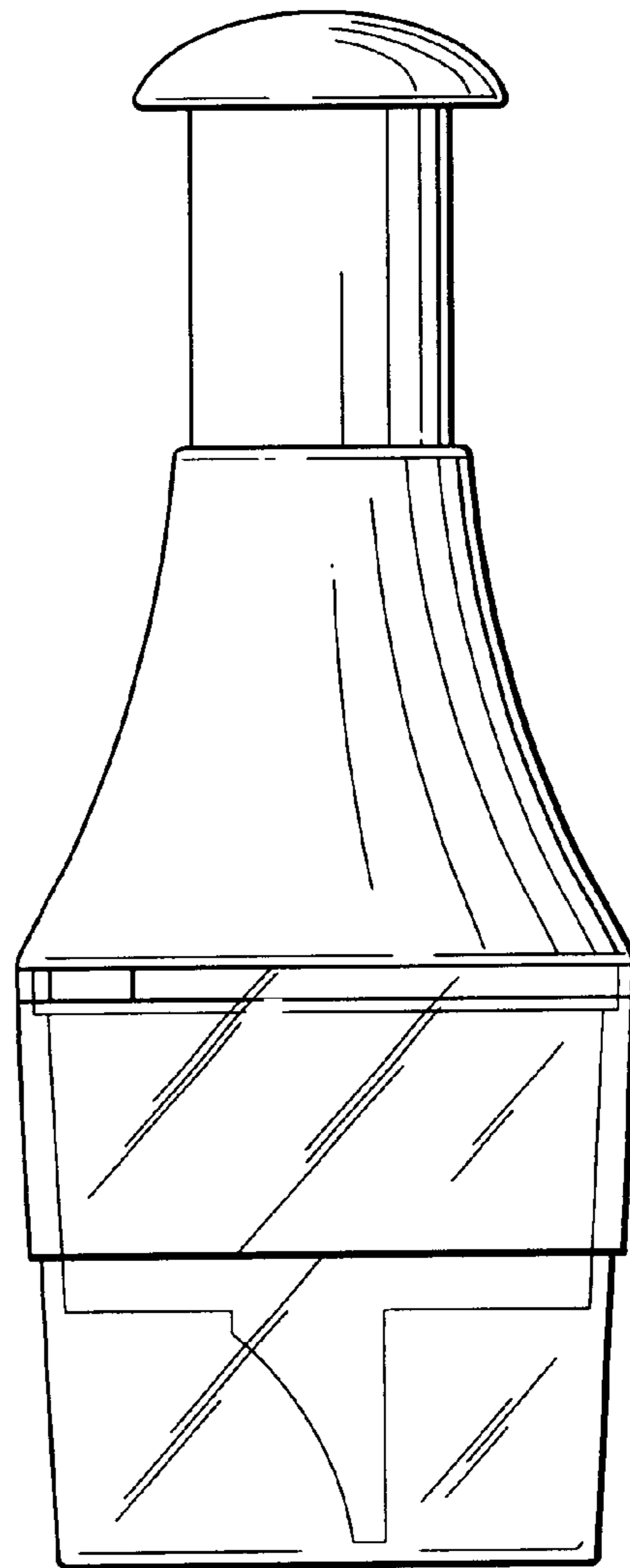

FIG. 9

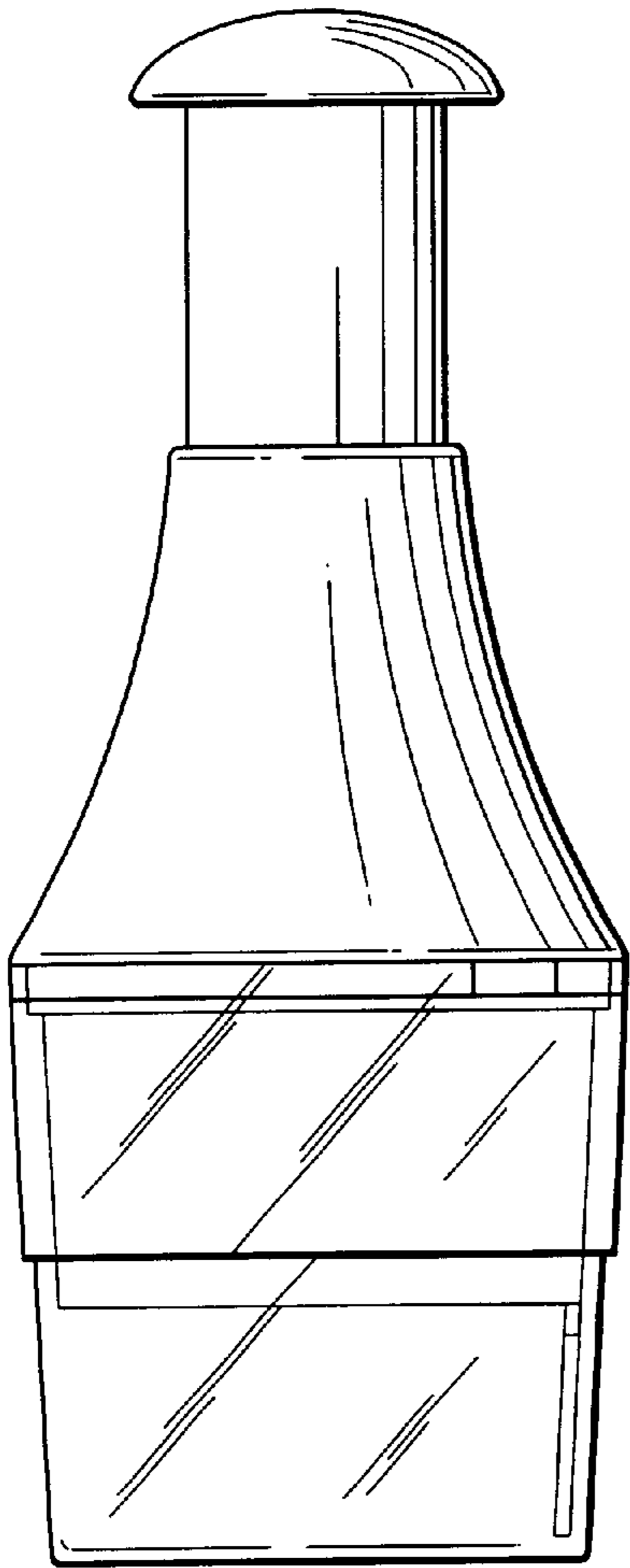

FIG. 10

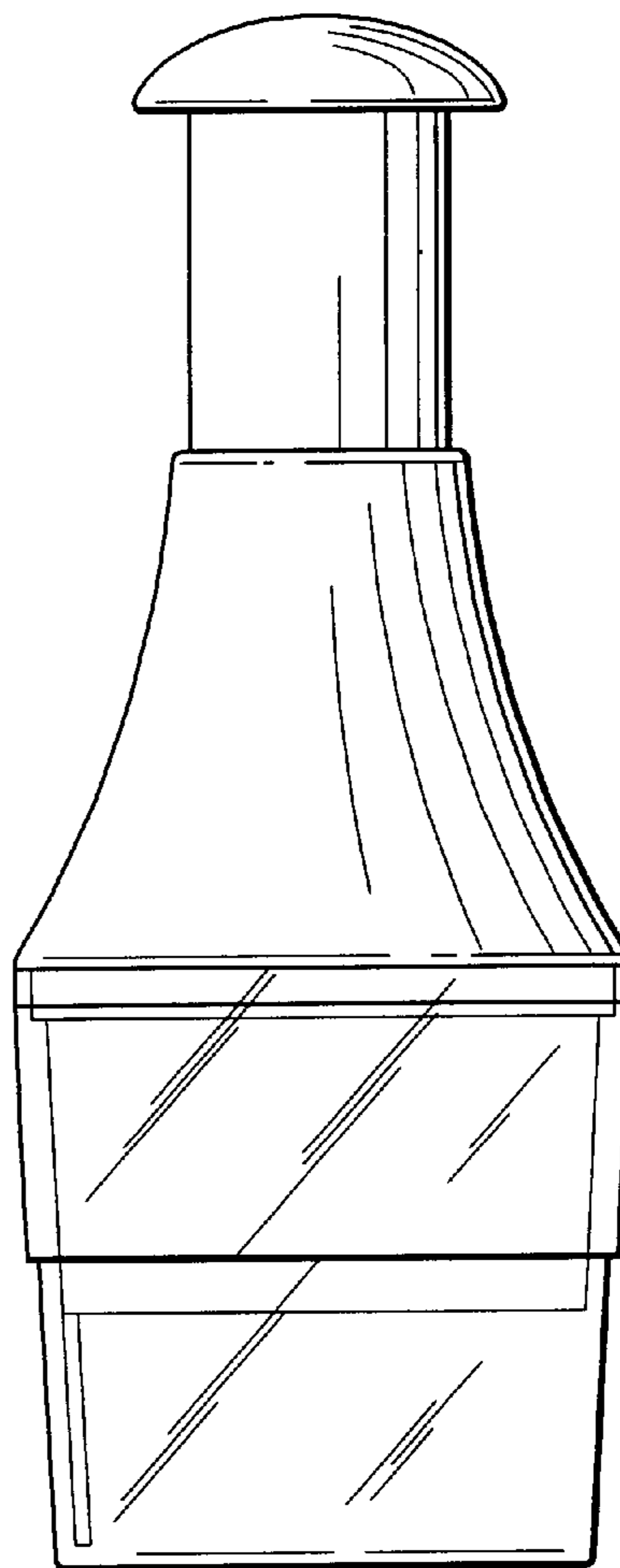

FIG. 11

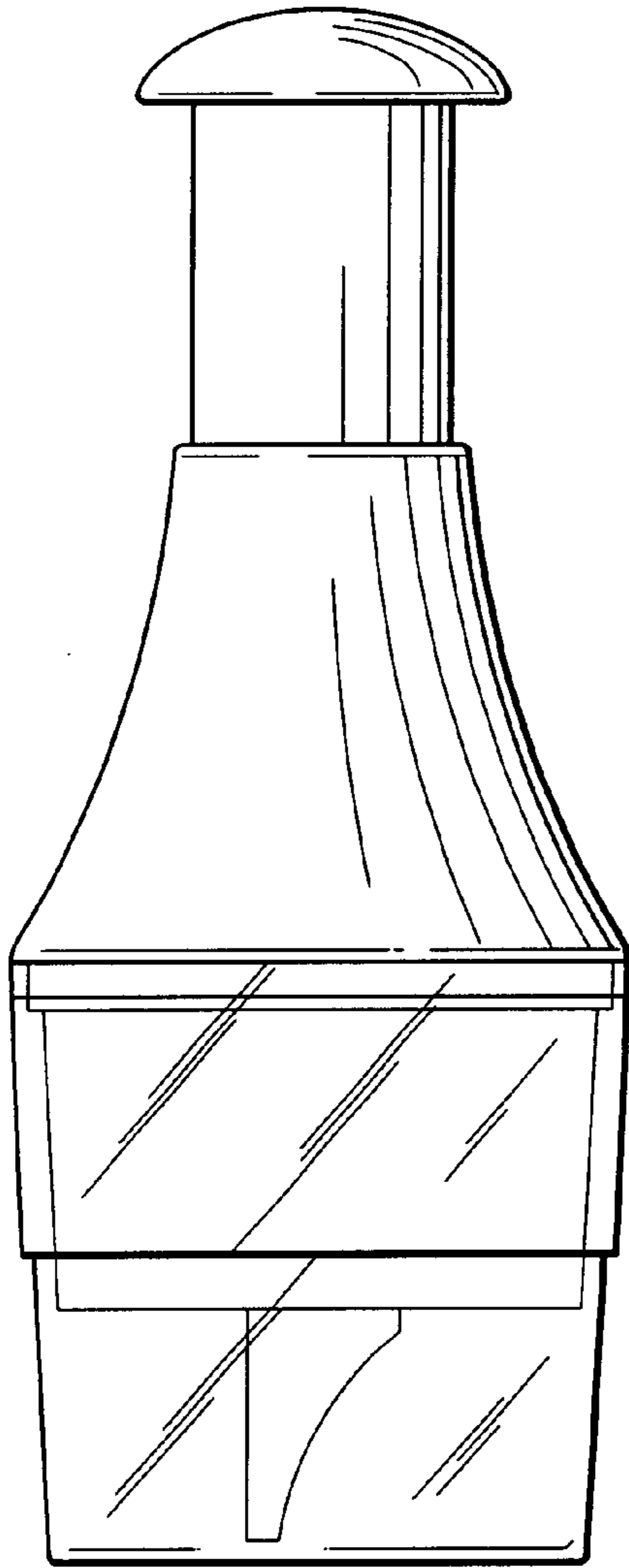

FIG. 12

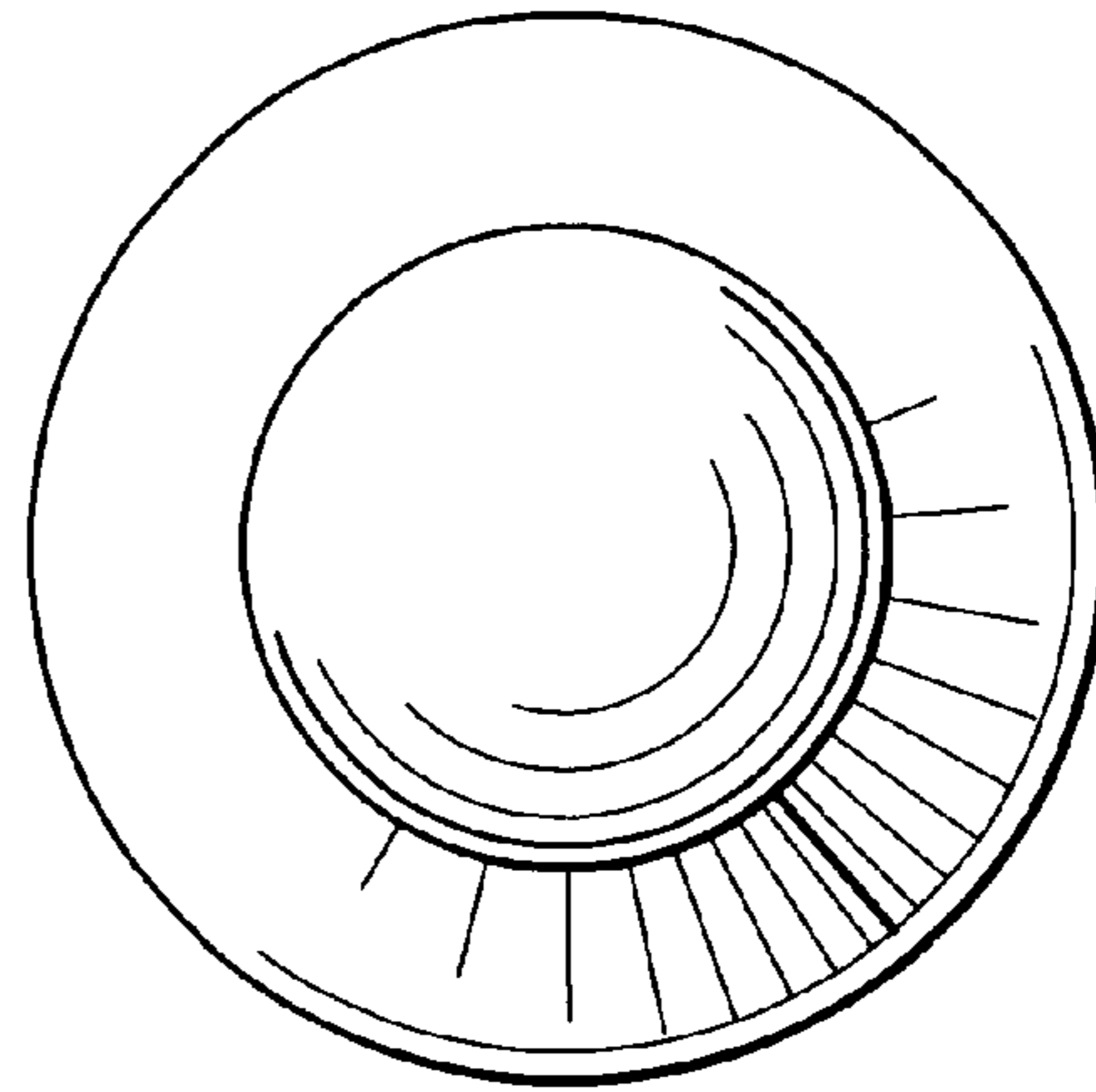

FIG. 13

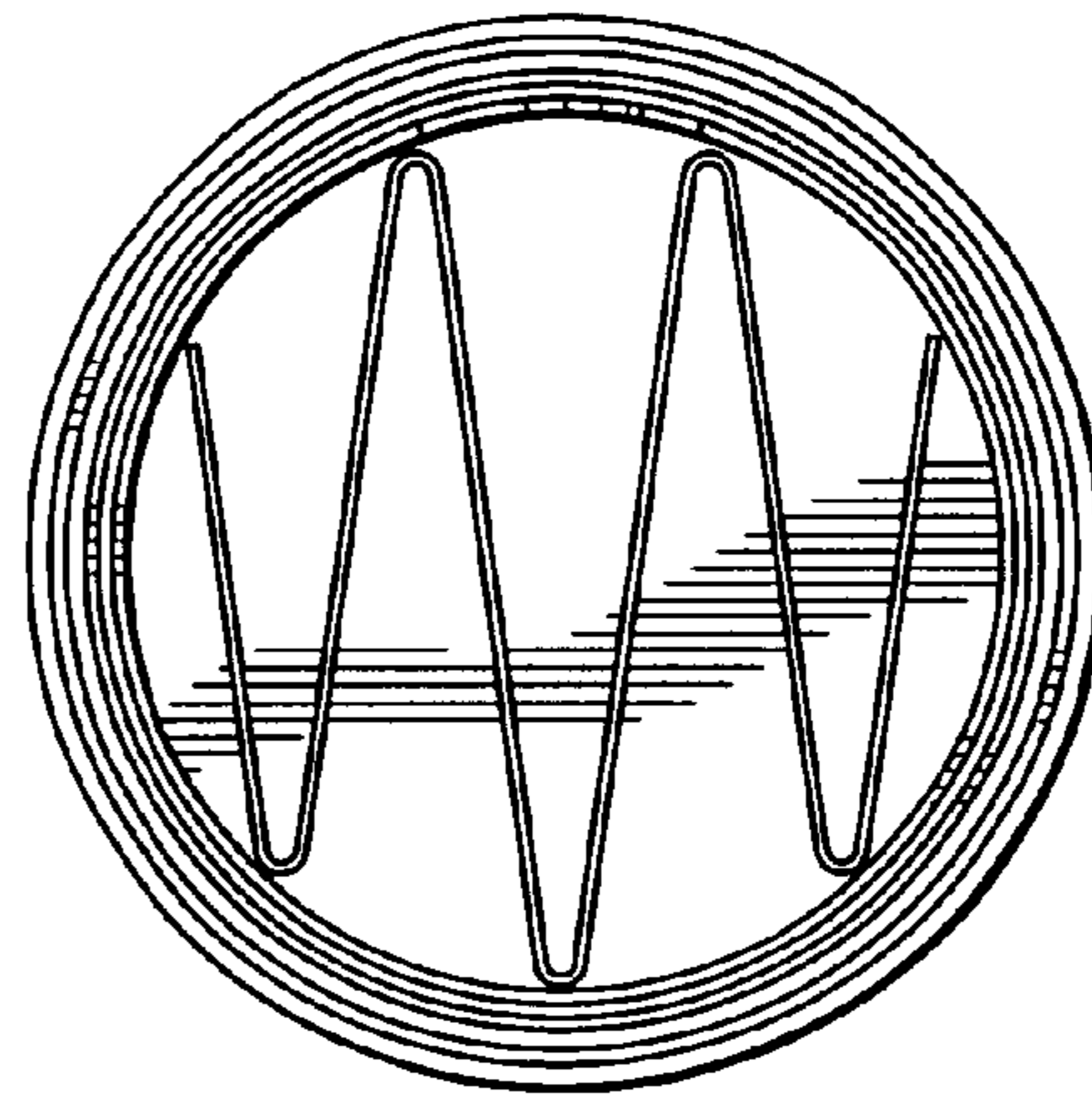

FIG. 14