



US00D515859S

(12) **United States Design Patent**  
**Gilbert**

(10) **Patent No.:** **US D515,859 S**

(45) **Date of Patent:** **\*\* Feb. 28, 2006**

- (54) **ACCESSORY POST**
- (75) Inventor: **Christopher Jon Gilbert**, Moreland Hills, OH (US)
- (73) Assignee: **Moen Incorporated**, North Olmsted, OH (US)
- (\*\*) Term: **14 Years**
- (21) Appl. No.: **29/209,661**
- (22) Filed: **Jul. 20, 2004**
- (51) **LOC (8) Cl.** ..... **06-04**
- (52) **U.S. Cl.** ..... **D6/550**
- (58) **Field of Classification Search** ..... D6/546-550, D6/518-523; D8/300, 303, 315-321, 349, D8/354, 363, 373, 380; 108/28-29; 248/175, 248/176.1, 251, 302, 309.1; 16/110.1, 412, 16/415; 242/570, 590, 595-598; 211/13.1, 211/16, 60.1, 100, 86.01, 87.01, 88.01, 88.04, 211/105.1-105.2, 123, 182, 181.1  
See application file for complete search history.

- D439,139 S 3/2001 Kuo
- D451,325 S \* 12/2001 Lai ..... D6/524
- D452,402 S 12/2001 Chen
- D452,791 S \* 1/2002 Chen ..... D6/524
- D461,535 S 8/2002 Antonello et al.
- D463,936 S 10/2002 Chen
- D465,557 S 11/2002 Antonello et al.
- D465,558 S 11/2002 Ouyoung
- D466,743 S 12/2002 Ouyoung
- D466,745 S \* 12/2002 Chou ..... D6/550
- D466,746 S 12/2002 Chen
- D466,982 S 12/2002 Gerlach
- D472,307 S 3/2003 Blomstrom
- D472,416 S 4/2003 Yen
- D472,417 S 4/2003 Hunt
- D476,721 S 7/2003 Ouyoung
- D476,836 S 7/2003 Lai
- D477,738 S 7/2003 Gilbert
- D481,235 S 10/2003 Gilbert

\* cited by examiner

*Primary Examiner*—Brian N Vinson  
(74) *Attorney, Agent, or Firm*—Calfee, Halter & Griswold LLP

(56) **References Cited**

**U.S. PATENT DOCUMENTS**

- D289,676 S 5/1987 Evans et al.
- D354,549 S 1/1995 Jans
- D362,899 S 10/1995 Jans
- D364,216 S 11/1995 Hill et al.
- D372,300 S 7/1996 Fabian
- D405,160 S 2/1999 Lord
- D406,318 S 3/1999 Lord
- D407,931 S 4/1999 Sweetman
- D409,030 S 5/1999 Sweetman
- D417,995 S \* 12/1999 Chen ..... D6/550
- D422,824 S 4/2000 Moore et al.
- D423,085 S 4/2000 Meda
- D429,798 S 8/2000 Milrud et al.
- D434,116 S 11/2000 Meda
- D434,121 S 11/2000 Donath, Jr. et al.
- D436,275 S 1/2001 Lai

(57) **CLAIM**

The ornamental design for an accessory post, as shown and described.

**DESCRIPTION**

FIG. 1 is a perspective view of an accessory post of the new design;  
FIG. 2 is a side view of the accessory post of FIG. 1;  
FIG. 3 is a back view of the accessory post of FIG. 1;  
FIG. 4 is a top view of the accessory post of FIG. 1;  
FIG. 5 is a side view of the accessory post of FIG. 1;  
FIG. 6 is a front view of the accessory post of FIG. 1; and,  
FIG. 7 is a bottom view of the accessory post of FIG. 1.  
The portions of the Figures shown in phantom lines are not part of the claimed design but are for illustration only.

**1 Claim, 2 Drawing Sheets**

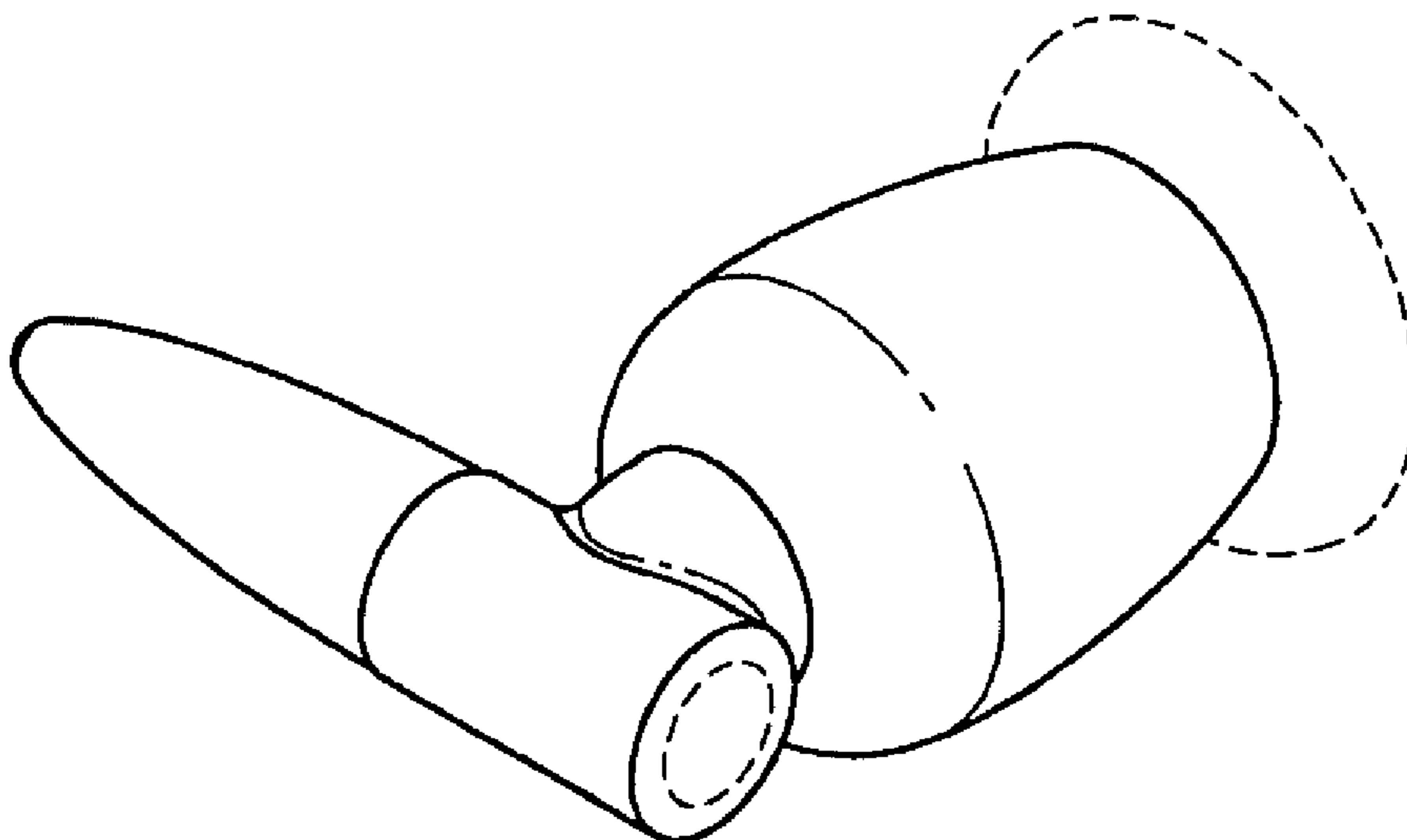

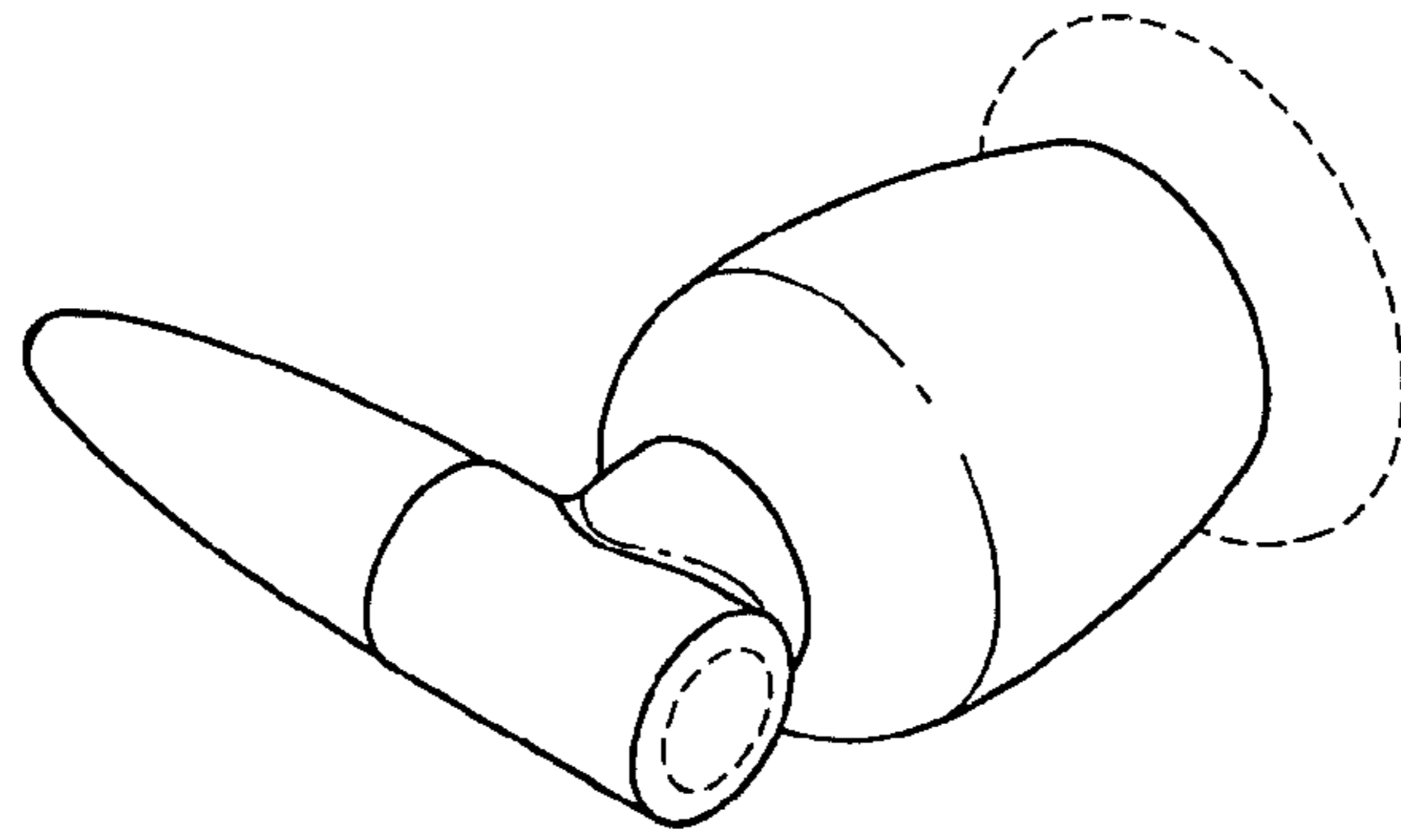

FIG. 1

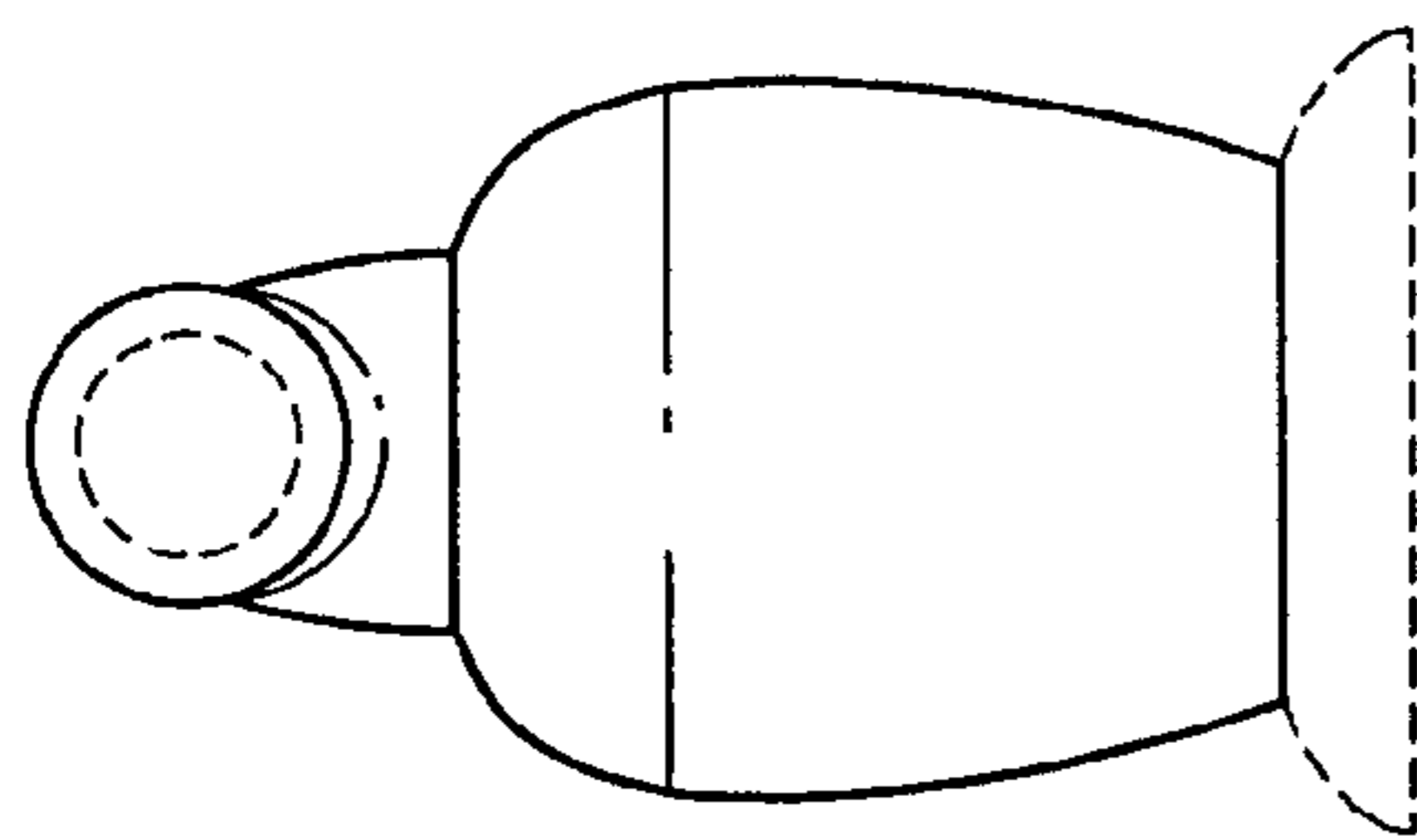

FIG. 2

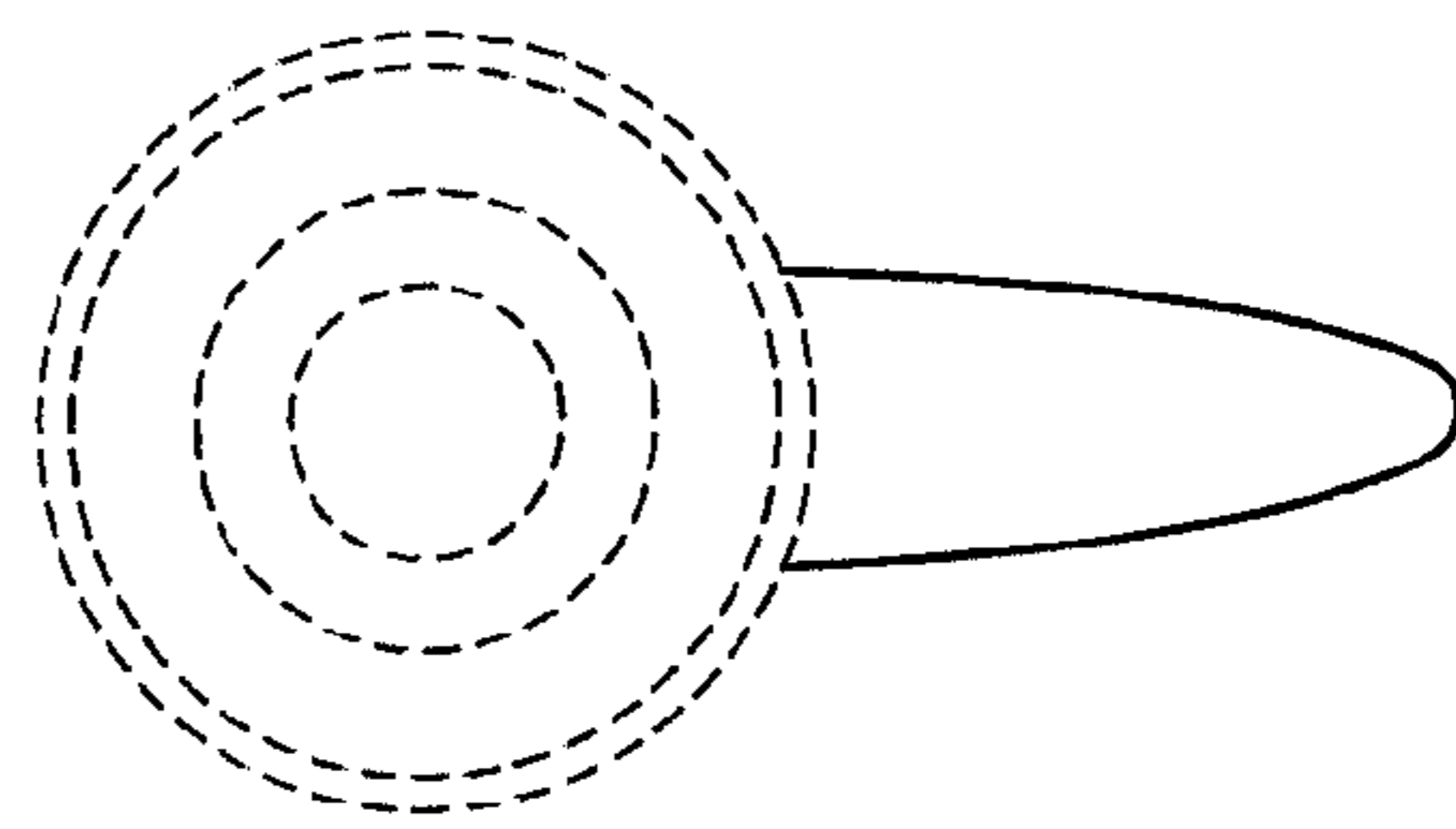

FIG. 3

FIG. 4

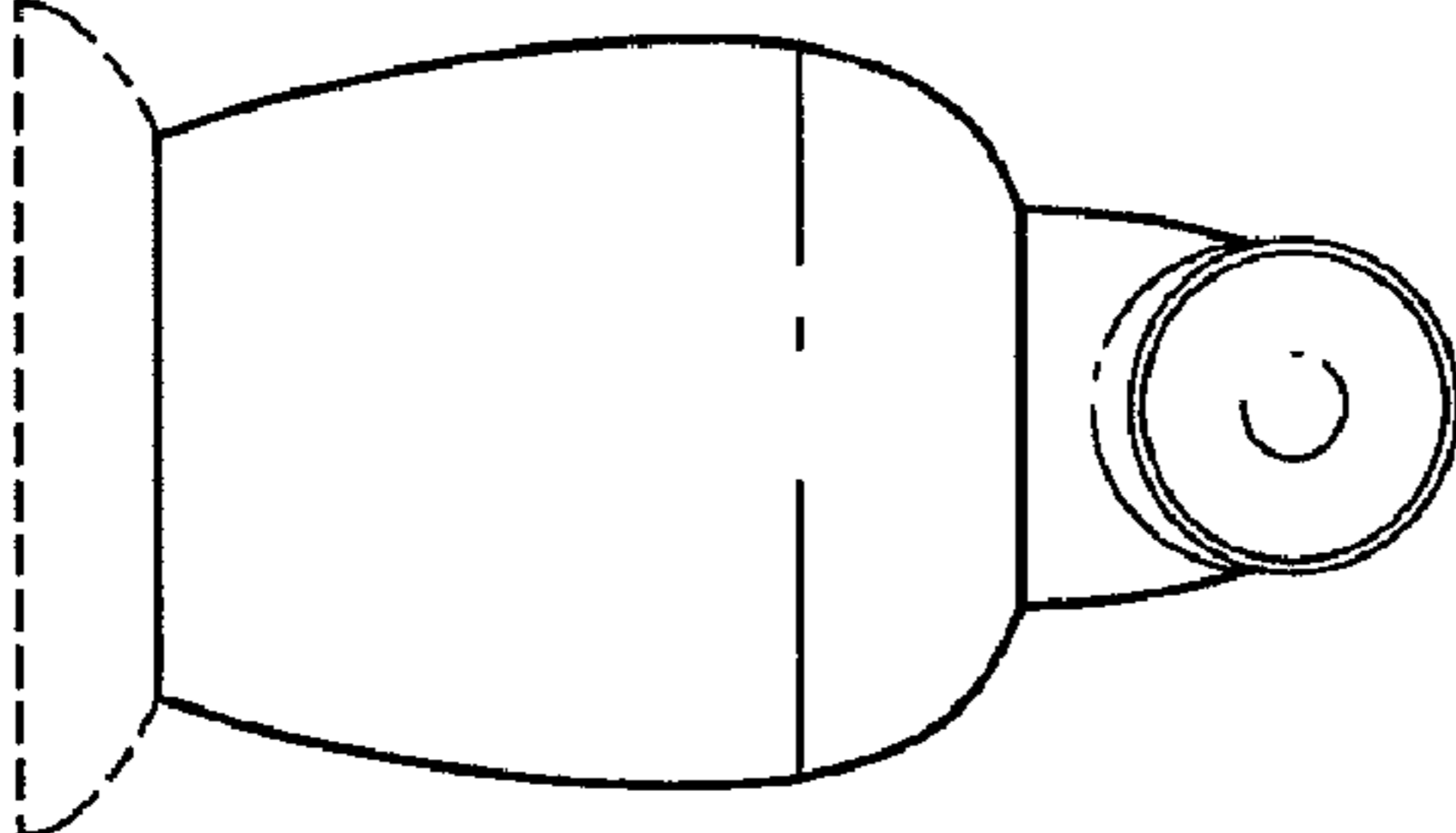
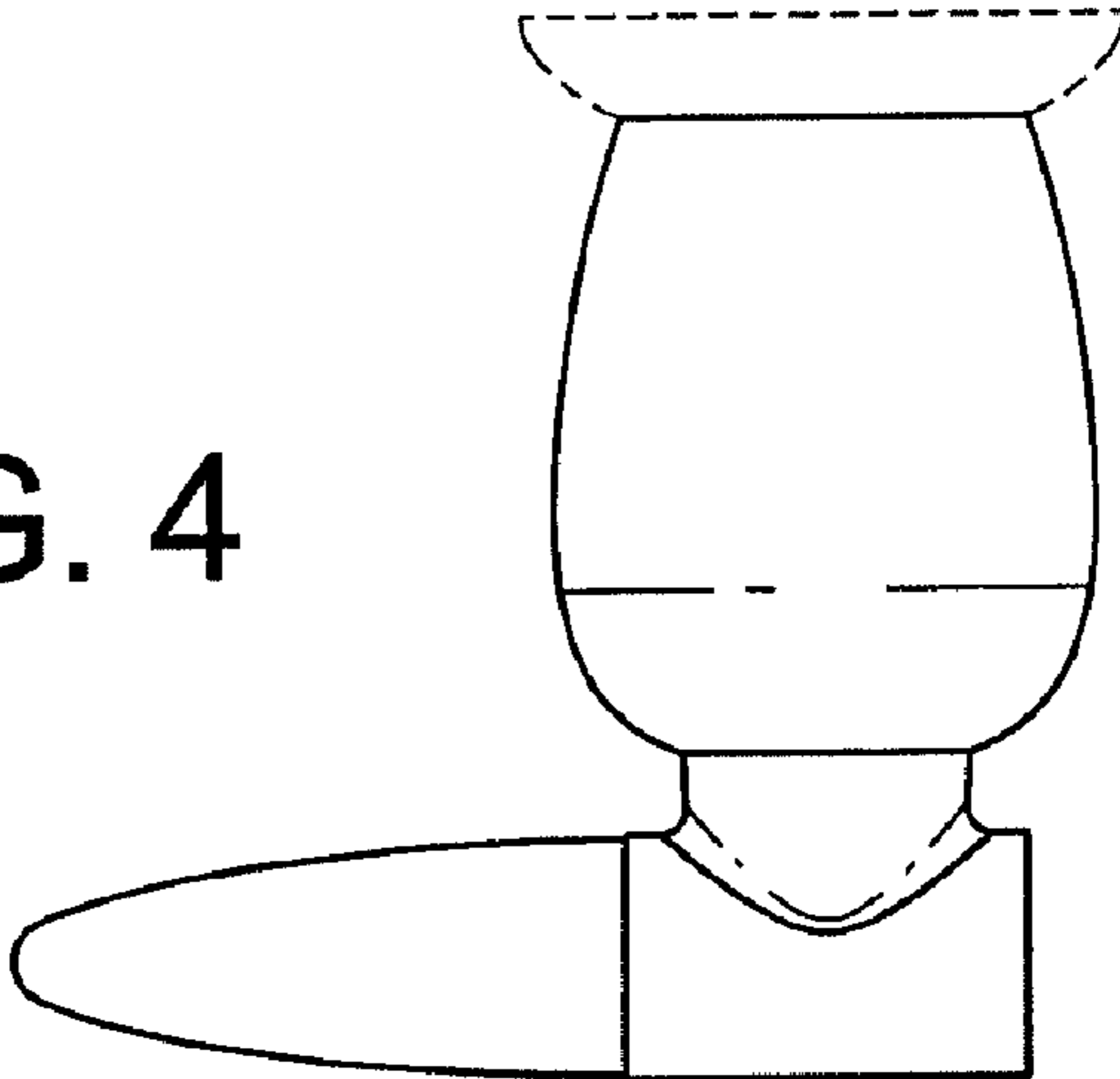

FIG. 5

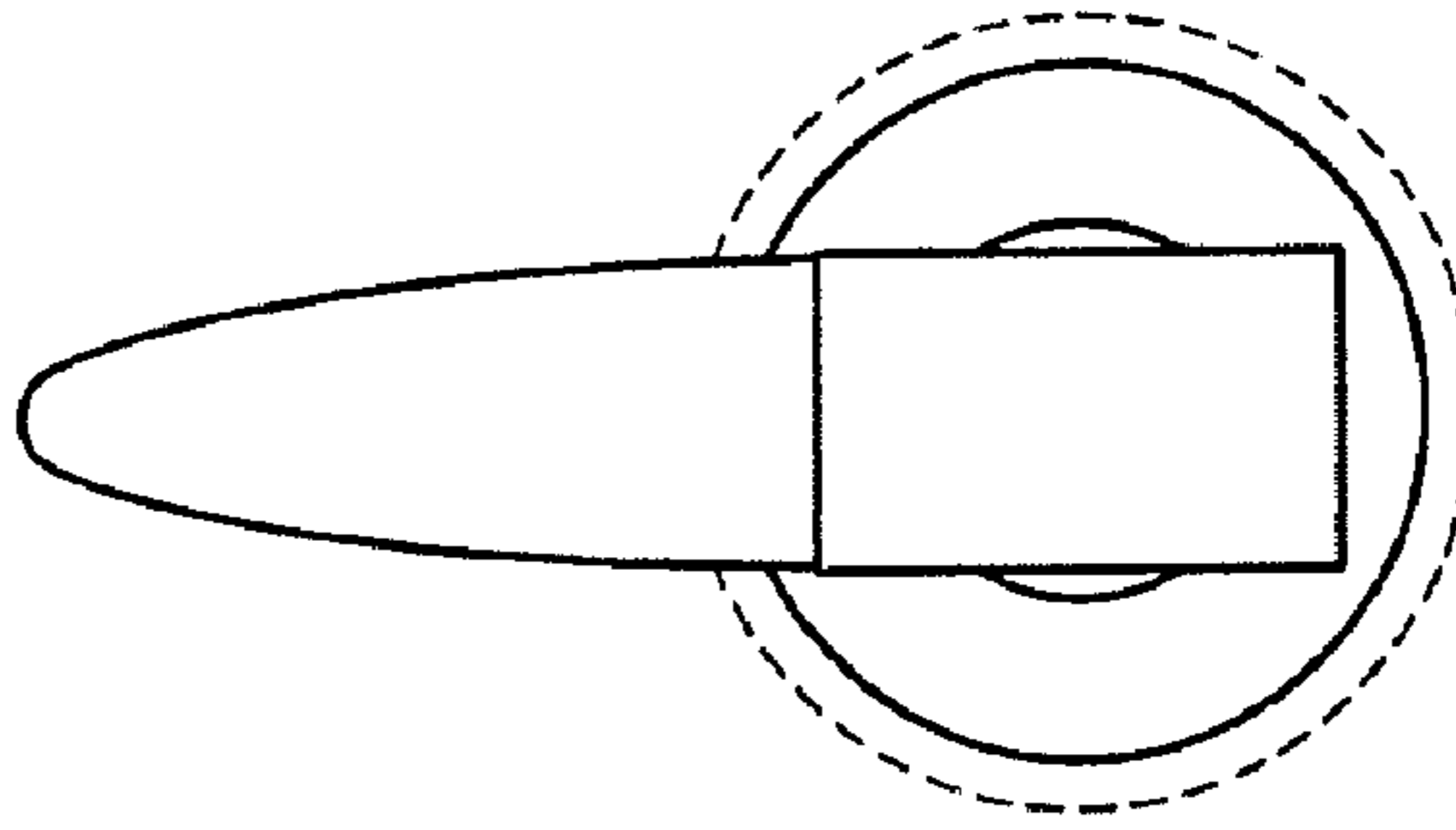

FIG. 6

FIG. 7

