



US00D515843S

(12) **United States Design Patent**
Tobas

(10) **Patent No.: US D515,843 S**
(45) **Date of Patent: ** Feb. 28, 2006**

(54) **CONTAINER HOLDER**

(76) **Inventor: Jerome J. Tobas**, 4228 Athens, Apt.
20G, Oklahoma City, OK (US) 73107

(**) **Term: 14 Years**

(21) **Appl. No.: 29/213,489**

(22) **Filed: Sep. 17, 2004**

(51) **LOC (8) Cl. 06-04**

(52) **U.S. Cl. D6/462**

(58) **Field of Classification Search** 211/13.1,
211/71.01, 74, 85.31, 85.18, 85.23, 181.1;
D6/450, 462; D11/148; 47/39, 40, 68, 45,
47/904; 248/107, 153, 175

See application file for complete search history.

(56) **References Cited**

U.S. PATENT DOCUMENTS

2,304,810 A	*	12/1942	Fetterman	248/153
2,506,321 A	*	5/1950	Vosburgh	248/153
D179,234 S	*	11/1956	Aden	D24/199
6,854,210 B2	*	2/2005	Gunderman	47/39

* cited by examiner

Primary Examiner—Holly Baynham

Assistant Examiner—Sydney R. Buffalow

(74) *Attorney, Agent, or Firm*—Dunlap, Coddling & Rogers,
P.C.

(57) **CLAIM**

The ornamental design for a container holder, as shown and described.

DESCRIPTION

FIG. 1 is a perspective view of a container holder showing my new design supporting a flower pot shown in broken lines.

FIG. 2 is a front elevational view thereof.

FIG. 3 is a rear elevational view thereof.

FIG. 4 is a side elevational view thereof.

FIG. 5 is a side elevational view a side opposite that shown in FIG. 4.

FIG. 6 is a top plan view thereof.

FIG. 7 is a bottom plan view thereof.

FIG. 8 is a perspective view of another embodiment of a container holder showing my new design supporting a flower pot shown in broken lines.

FIG. 9 is a front elevational view thereof.

FIG. 10 is a rear elevational view thereof.

FIG. 11 is a side elevational view thereof.

FIG. 12 is a side elevational view of a side opposite that shown in FIG. 11.

FIG. 13 is a top plan view thereof; and,

FIG. 14 is a bottom plan view thereof.

The broken lines shown in FIGS. 1 and 8 are for purposes of illustrating environment only and form no part of the claimed design.

1 Claim, 6 Drawing Sheets

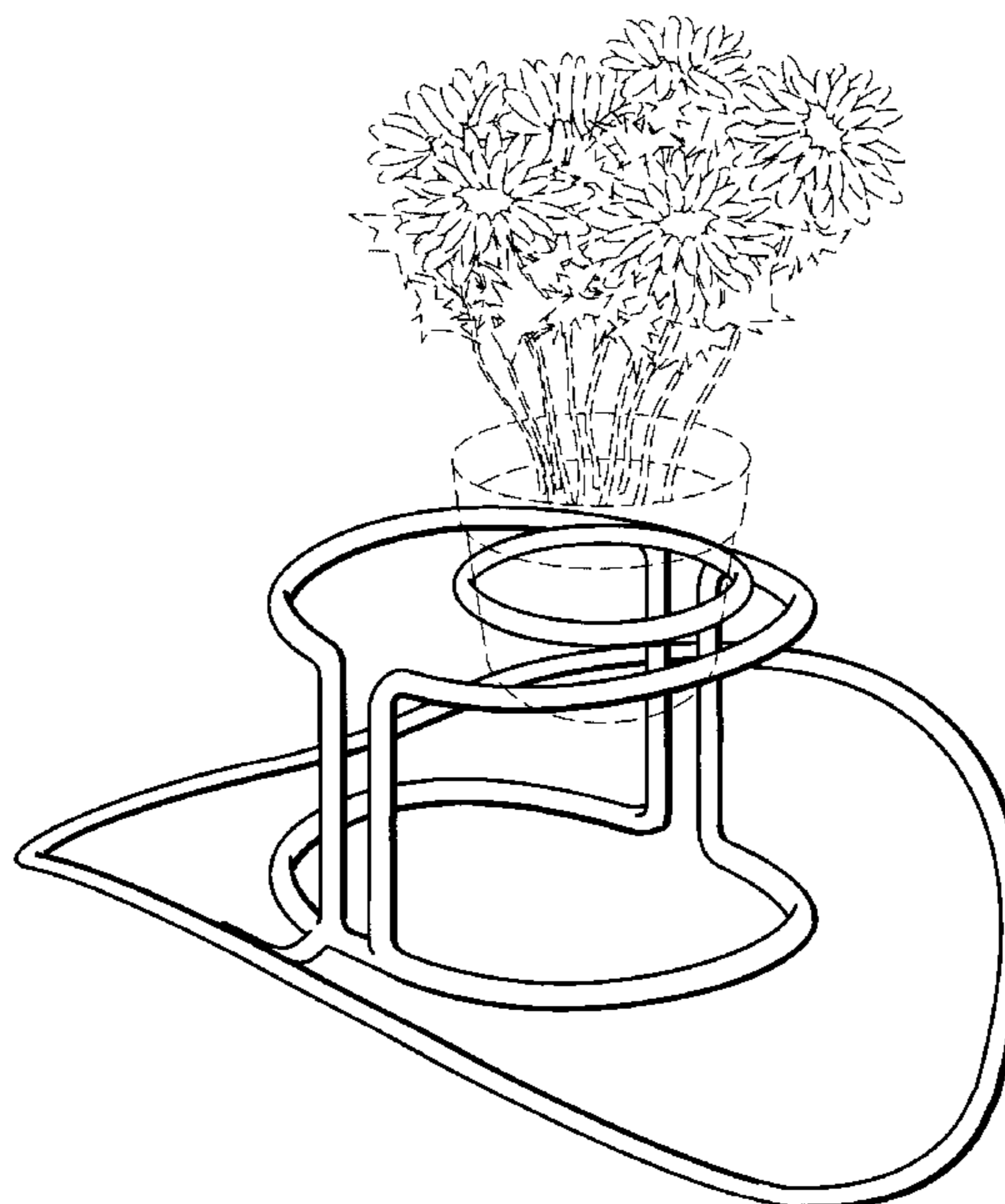
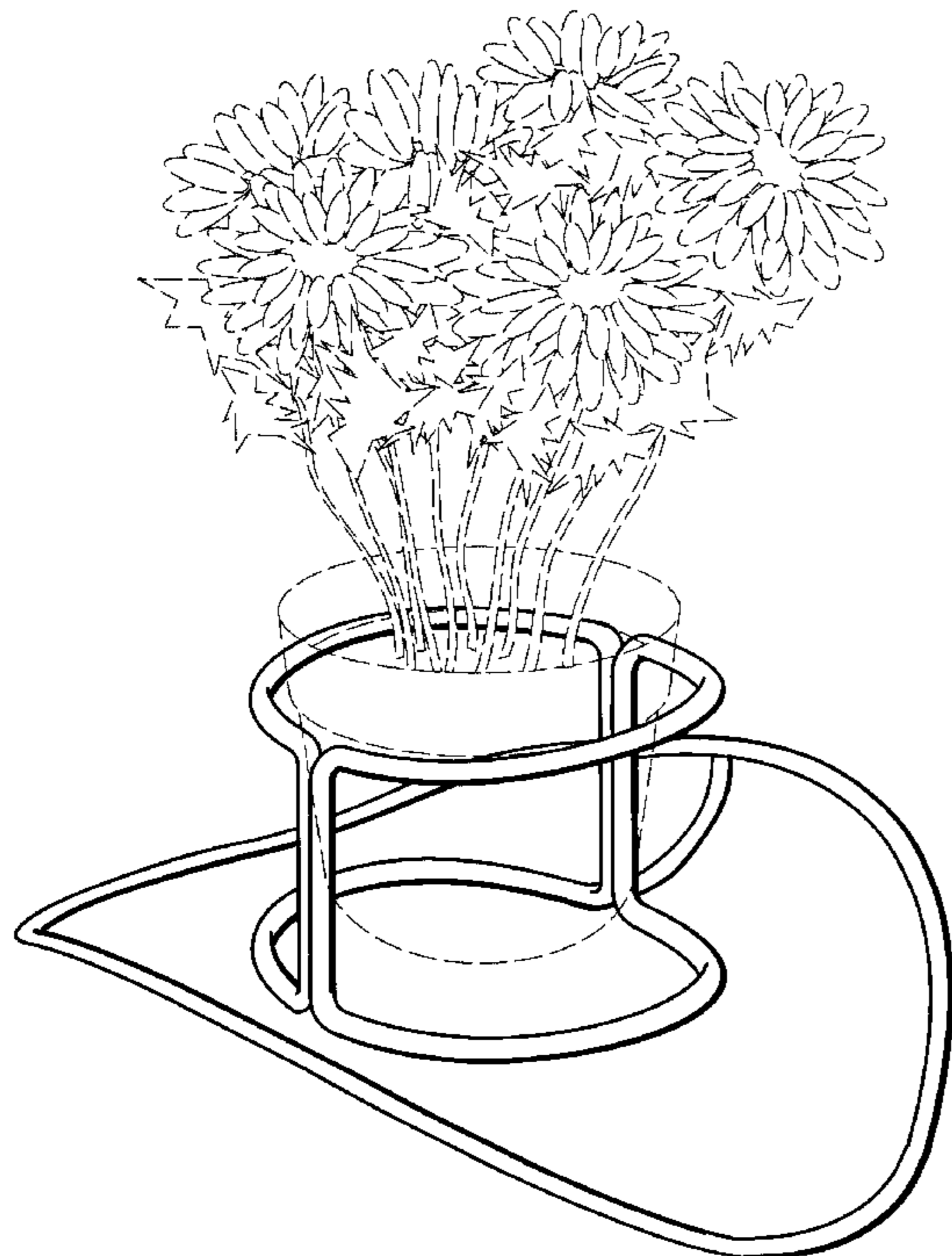

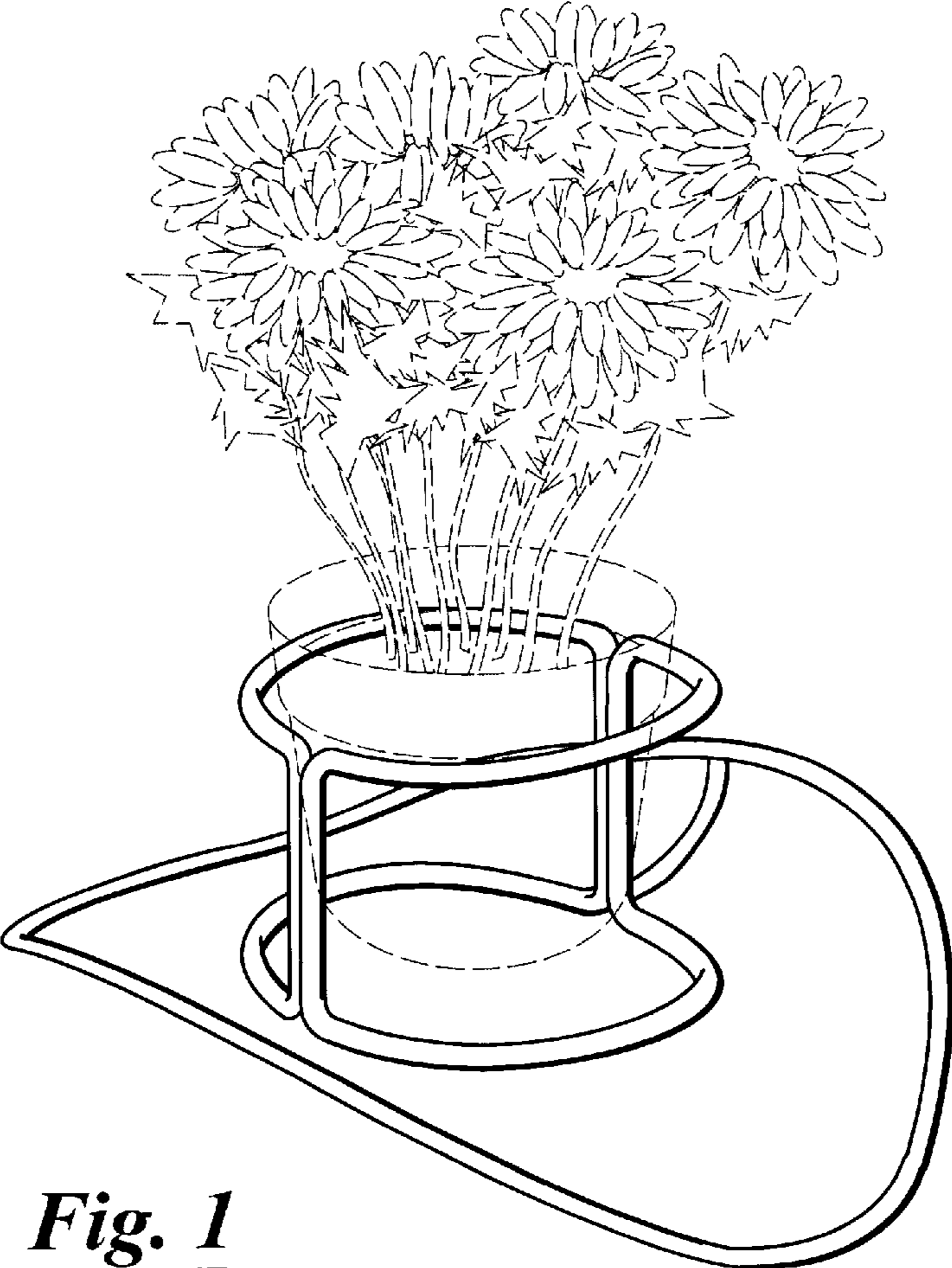

Fig. 1

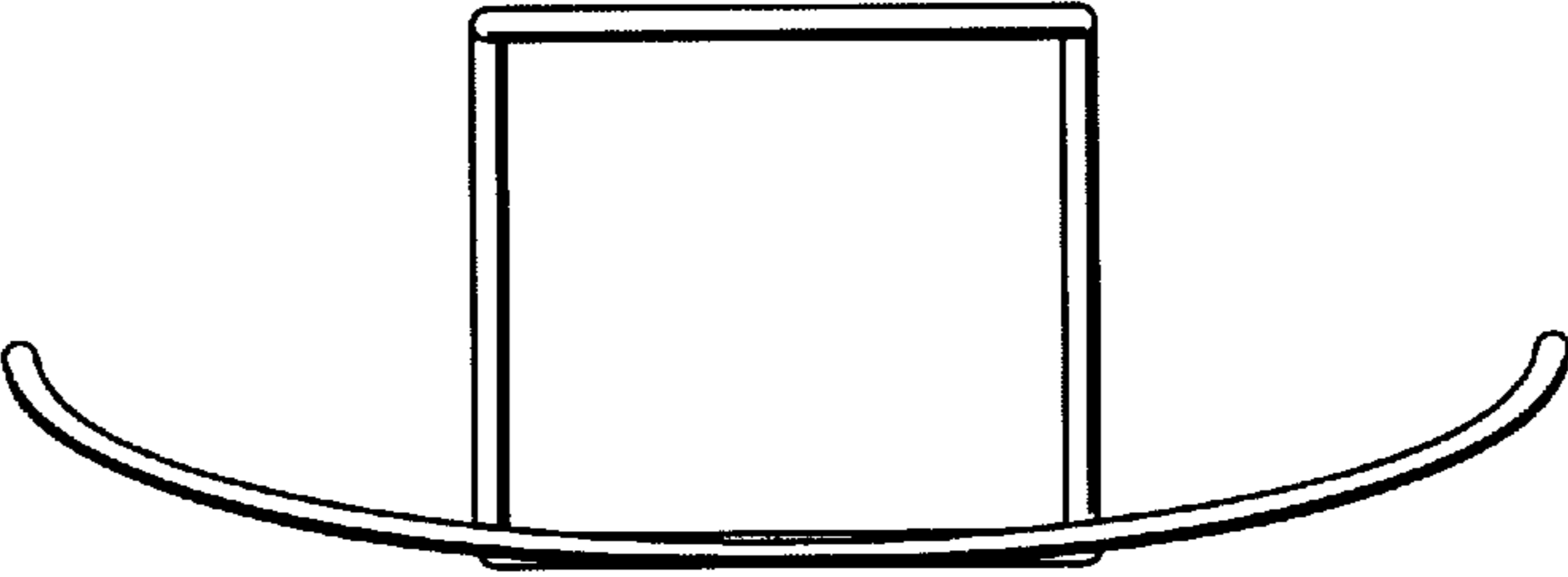

Fig. 2

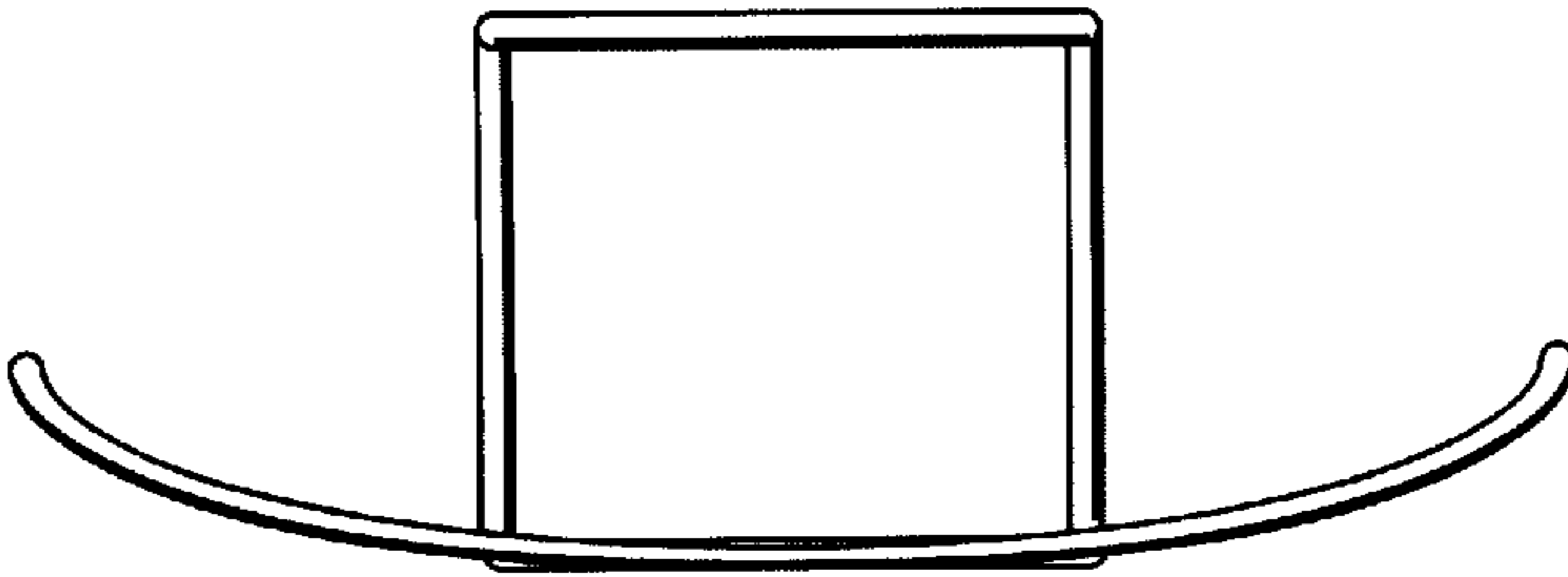

Fig. 3

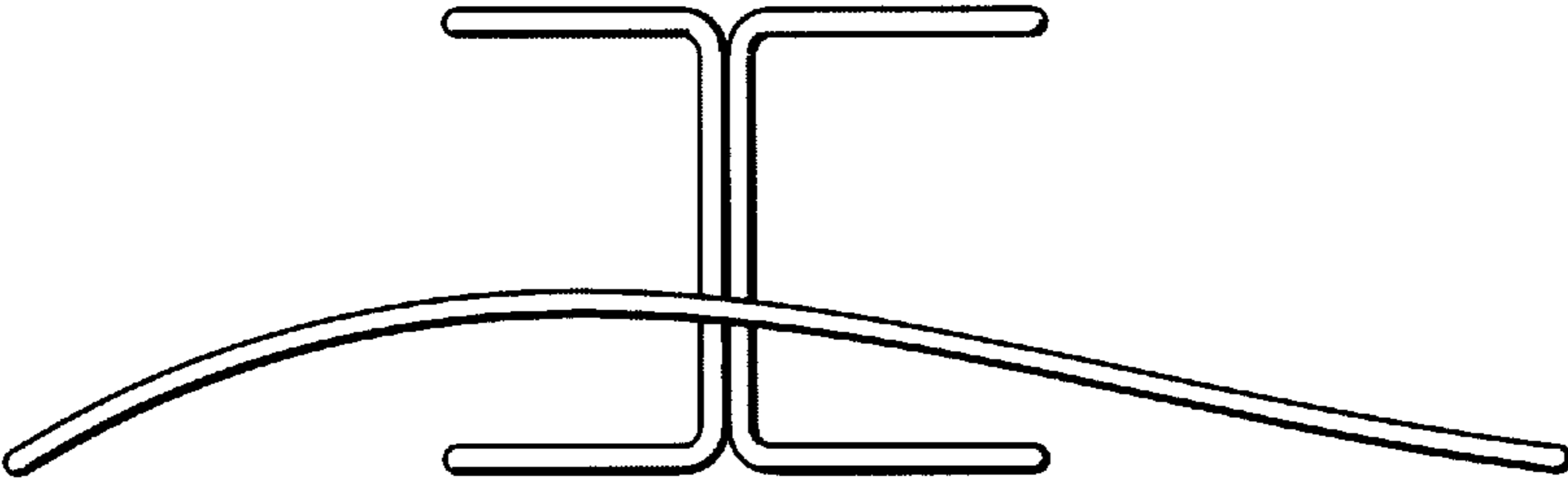

Fig. 4

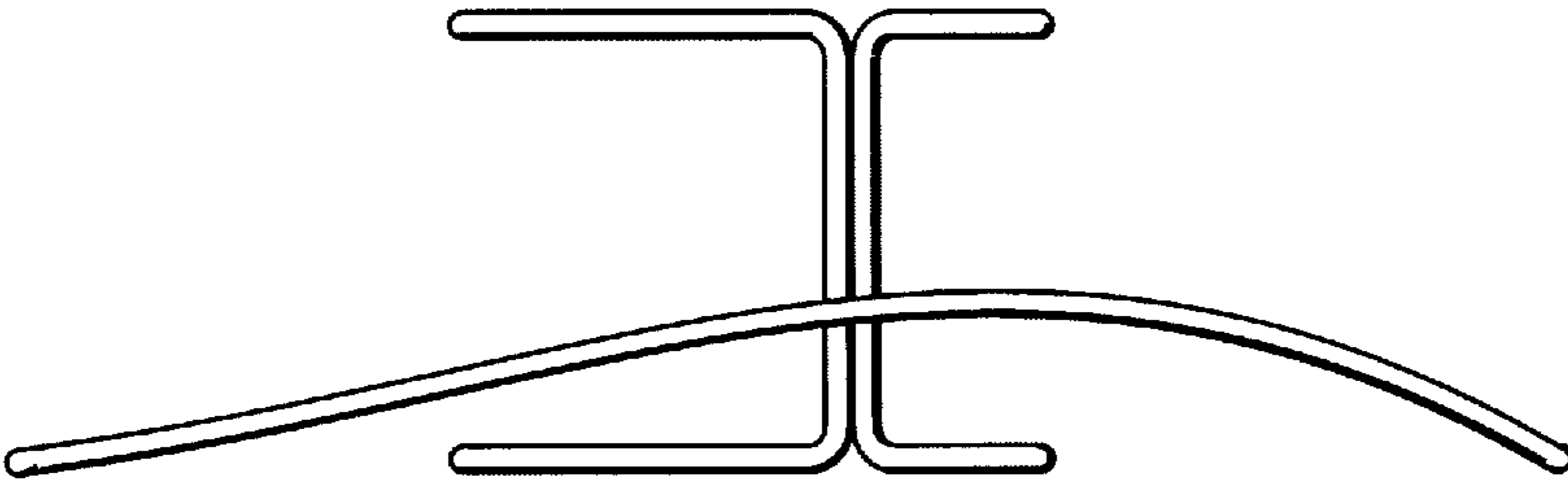

Fig. 5

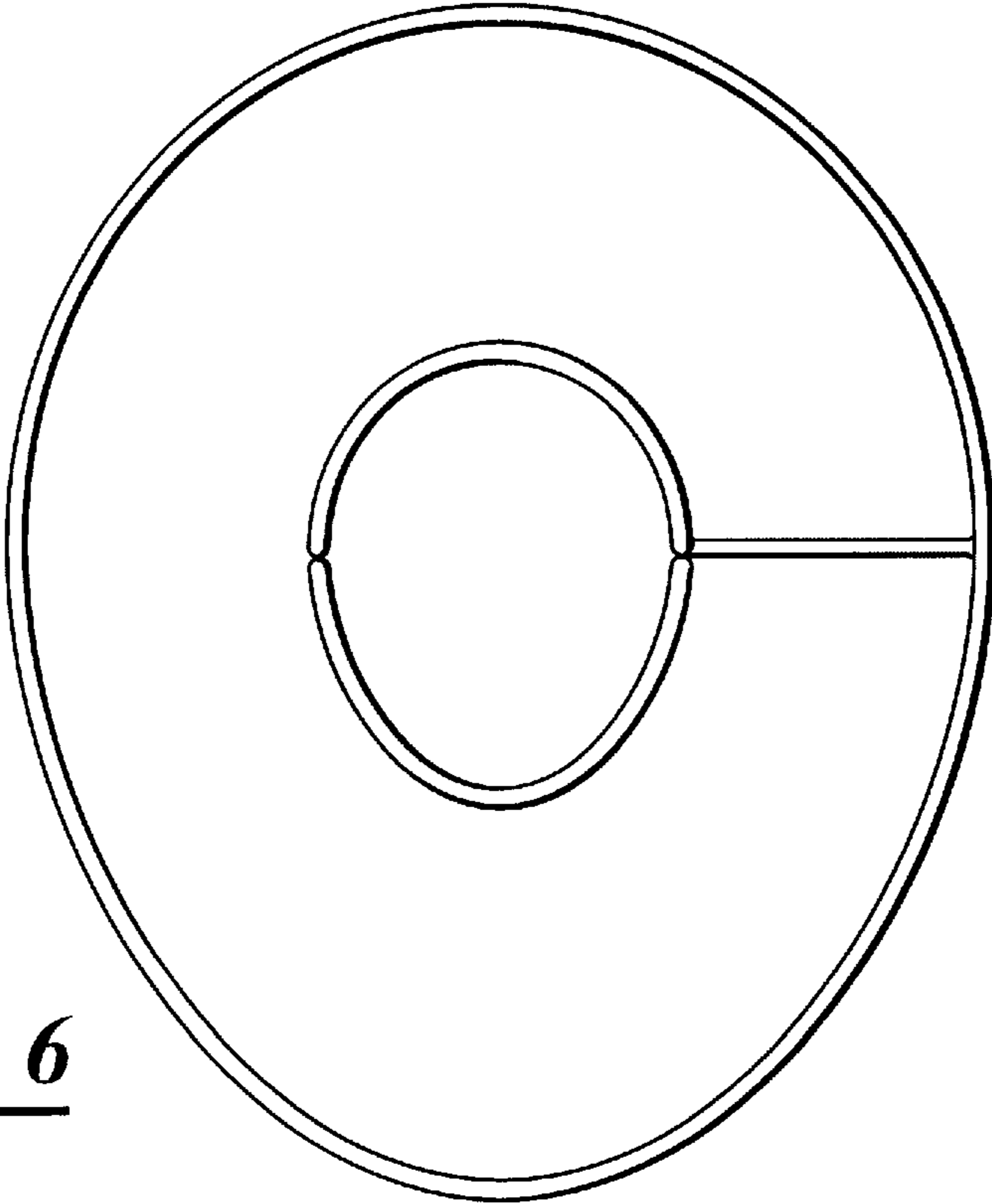

Fig. 6

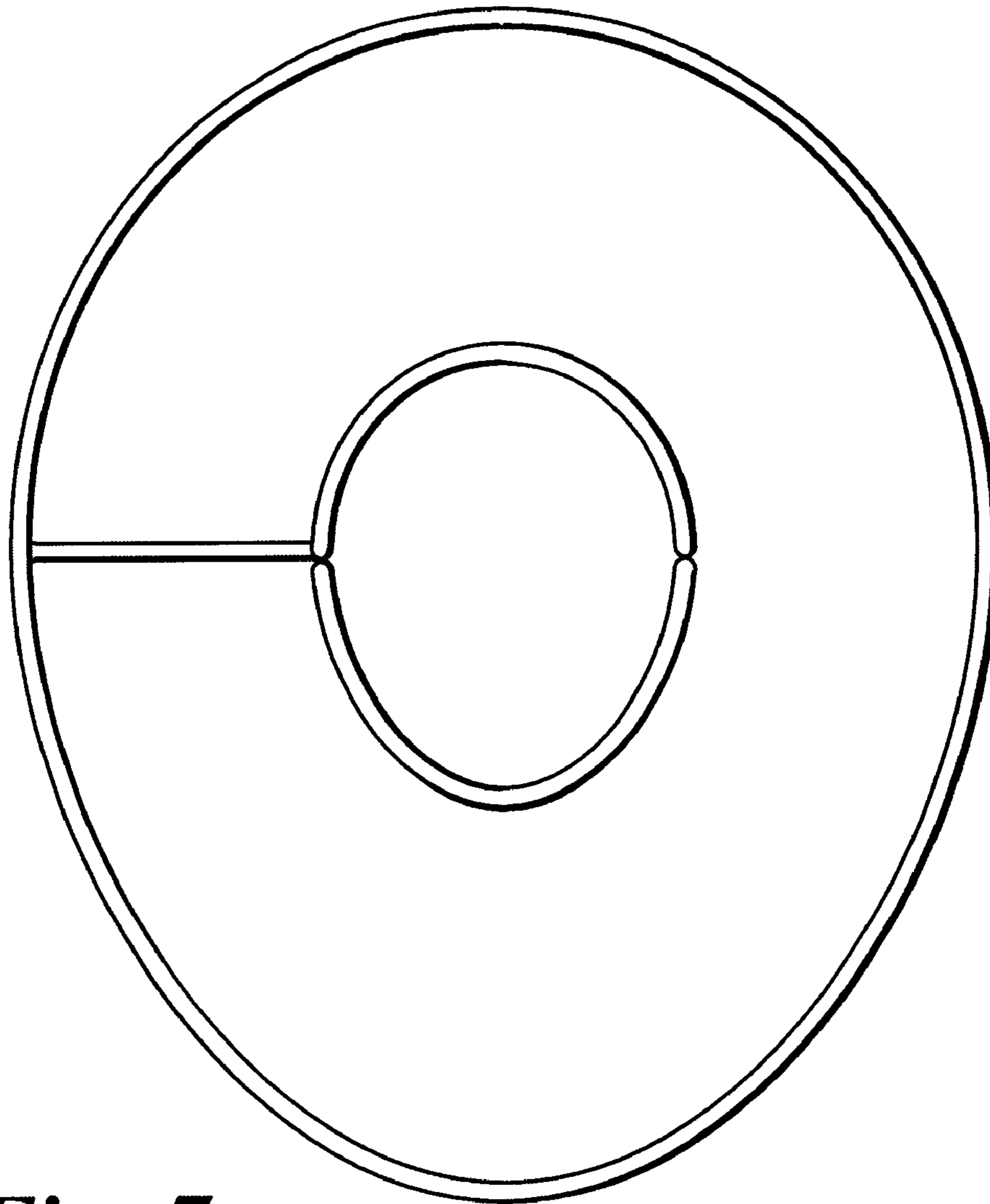

Fig. 7

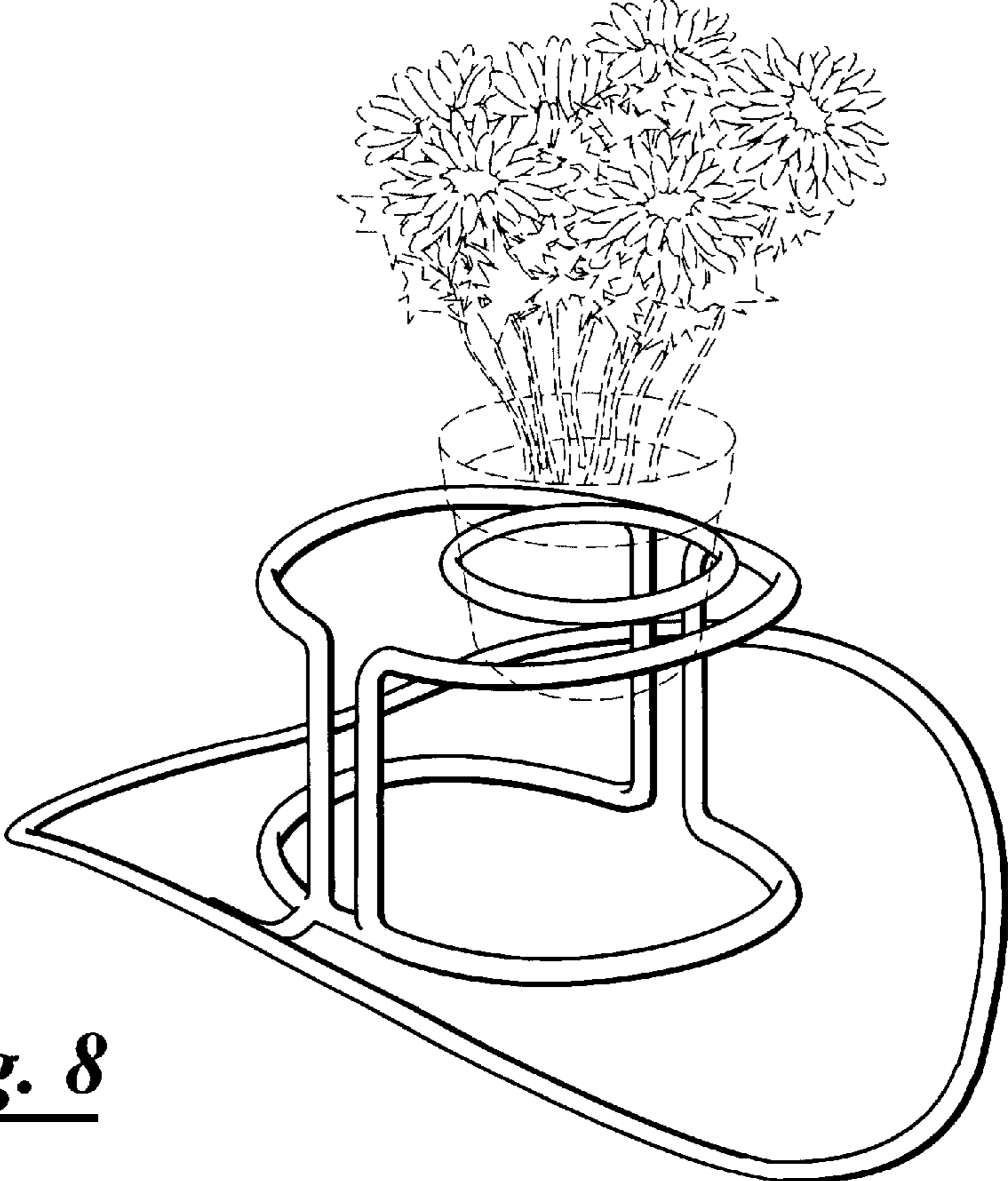

Fig. 8

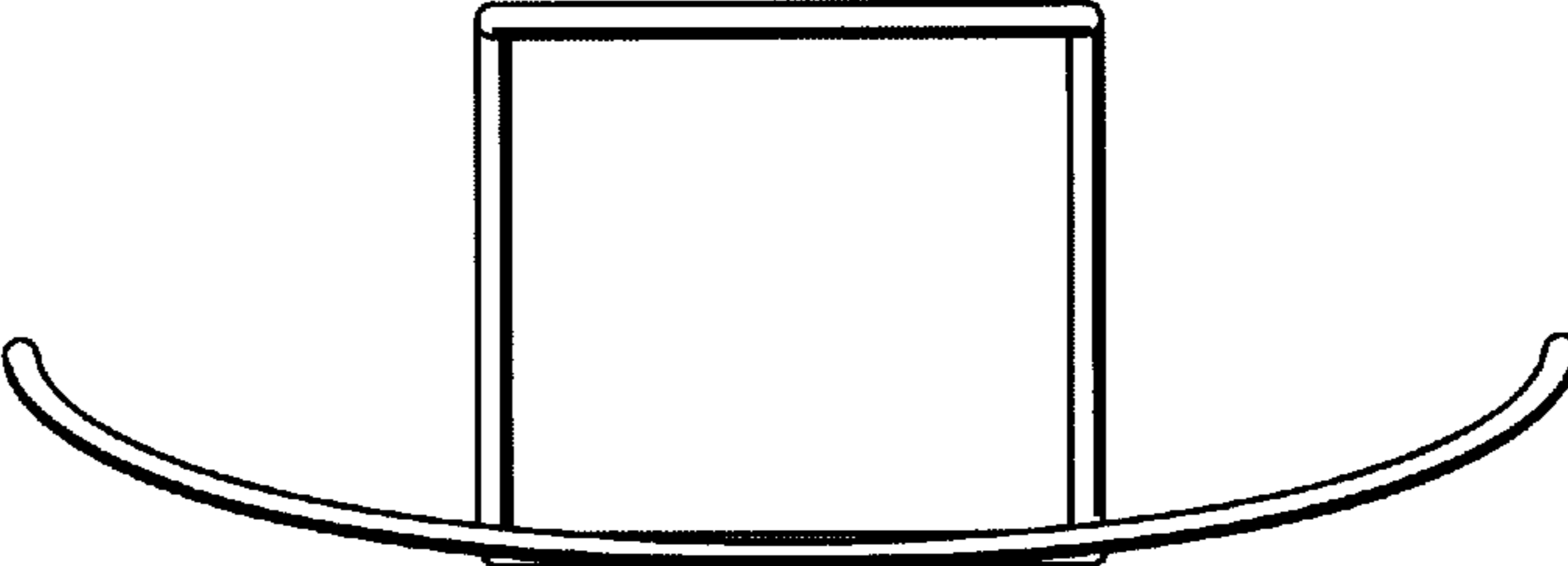

Fig. 9

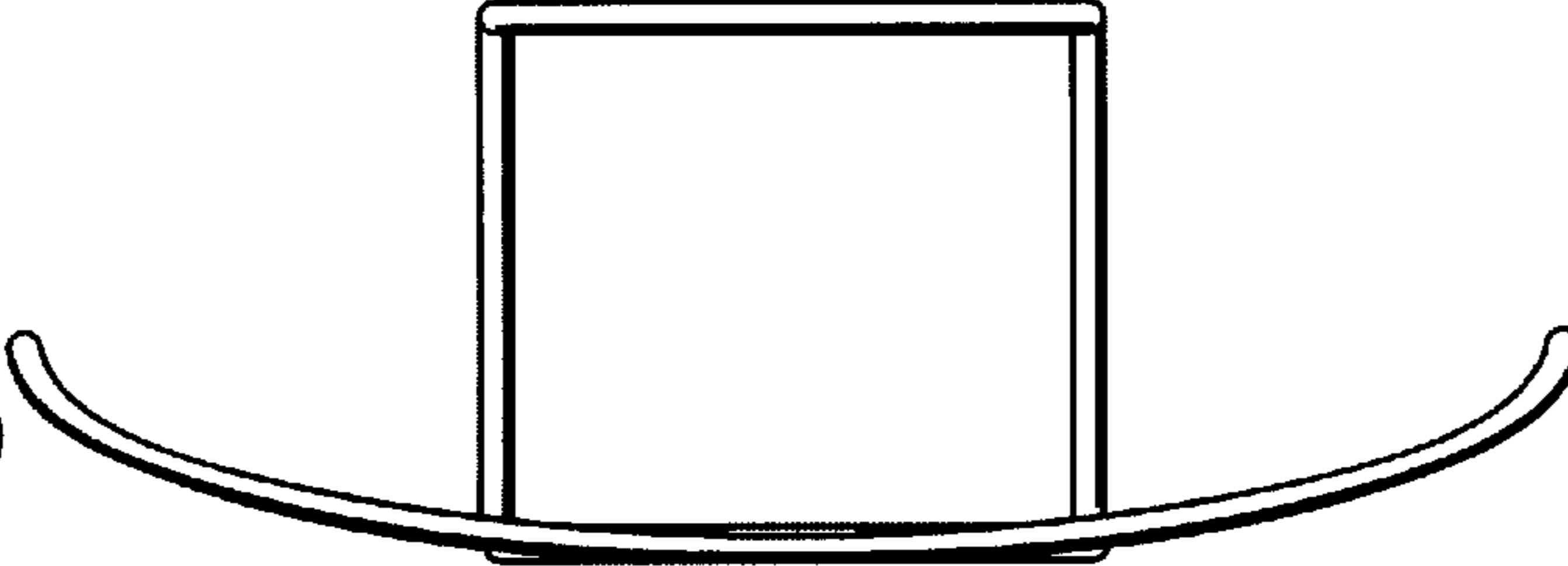

Fig. 10

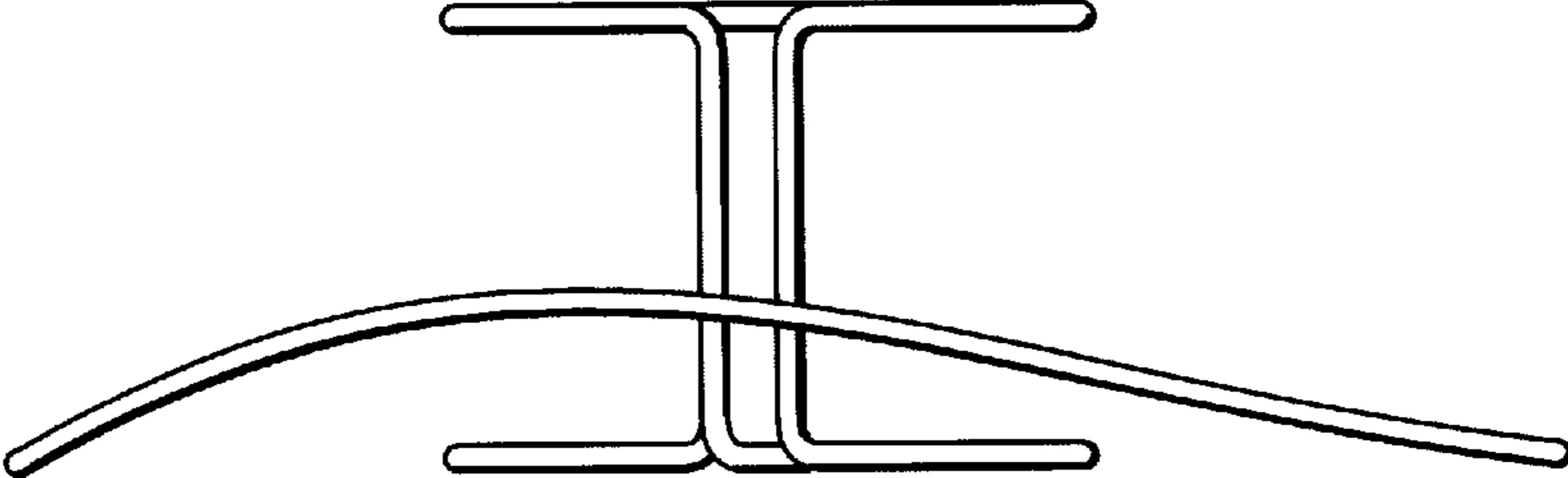

Fig. 11

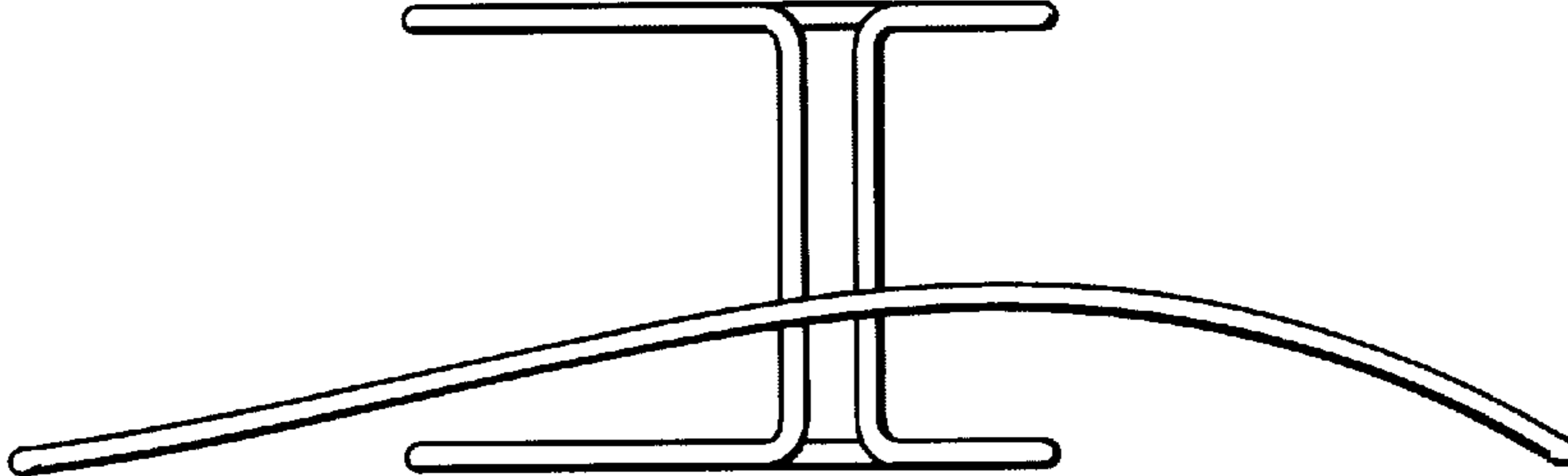

Fig. 12

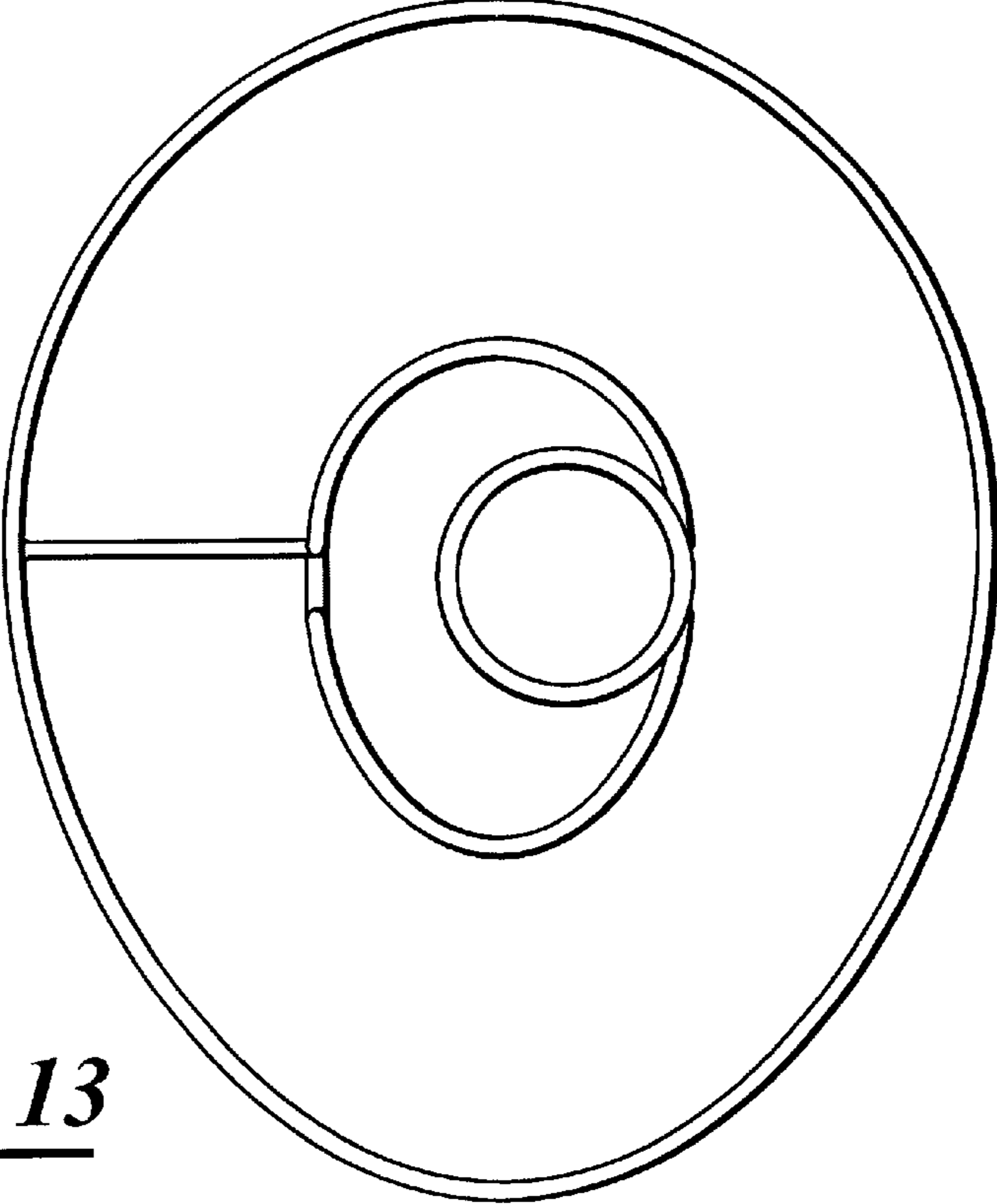

Fig. 13

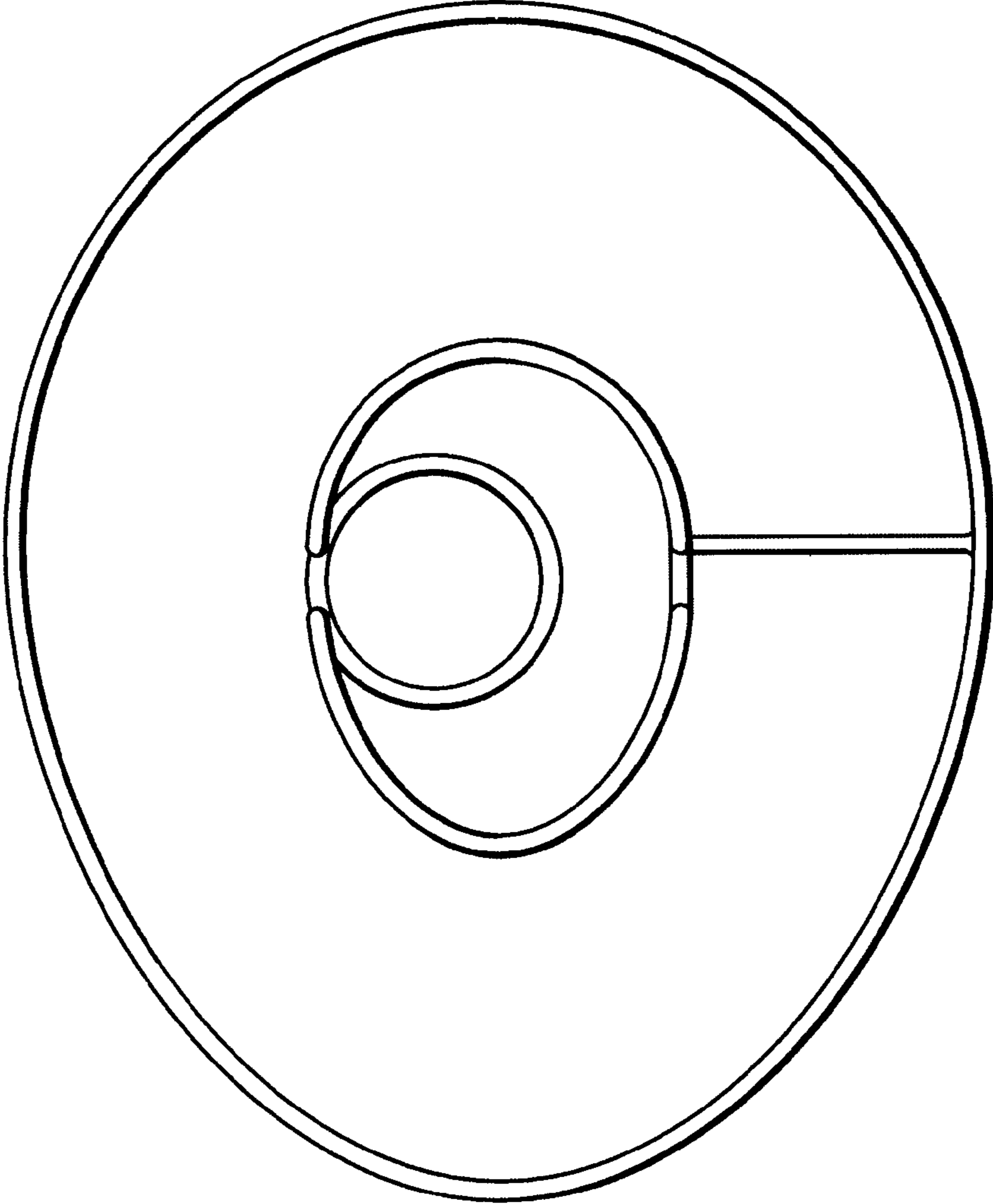

Fig. 14