



US00D515752S

(12) **United States Design Patent**
Rosenzweig

(10) **Patent No.: US D515,752 S**

(45) **Date of Patent: ** Feb. 21, 2006**

(54) **VACUUM CLEANER**

(75) Inventor: **Mark Rosenzweig**, Chestnut Hill, MA (US)

(73) Assignee: **Euro-Pro Operating LLC**, West Newton, MA (US)

(**) Term: **14 Years**

(21) Appl. No.: **29/201,342**

(22) Filed: **Mar. 15, 2004**

(51) **LOC (8) Cl. 15-05**

(52) **U.S. Cl. D32/18**

(58) **Field of Classification Search** 32/17-18, 32/21, 31; 15/344, 329, 347, 320-321, 412
See application file for complete search history.

(56) **References Cited**

U.S. PATENT DOCUMENTS

D468,068 S	*	12/2002	Mok	D32/18
D471,331 S	*	3/2003	Pan	D32/18
D474,867 S	*	5/2003	Robinson	D32/18
D475,819 S	*	6/2003	Milanese	D32/17
D495,454 S	*	8/2004	Lee	D32/18

2003/0037403 A1 * 2/2003 Lang 15/330

* cited by examiner

Primary Examiner—Ruth McInroy

(74) *Attorney, Agent, or Firm*—Shook, Hardy & Bacon

(57) **CLAIM**

The ornamental design for a vacuum cleaner, as shown and described.

DESCRIPTION

FIG. 1 is a front, perspective view of a vacuum cleaner according to my novel design;

FIG. 2 is a rear, perspective view thereof;

FIG. 3 is a left side view thereof;

FIG. 4 is a front view thereof;

FIG. 5 is a right side view thereof;

FIG. 6 is a rear view thereof;

FIG. 7 is a top view thereof;

FIG. 8 is a bottom view thereof; and,

FIG. 9 is a front perspective view thereof, including a hose in broken lines for illustrative purposes only.

The broken lines are for illustrative purposes only and form no part of the claimed design.

1 Claim, 5 Drawing Sheets

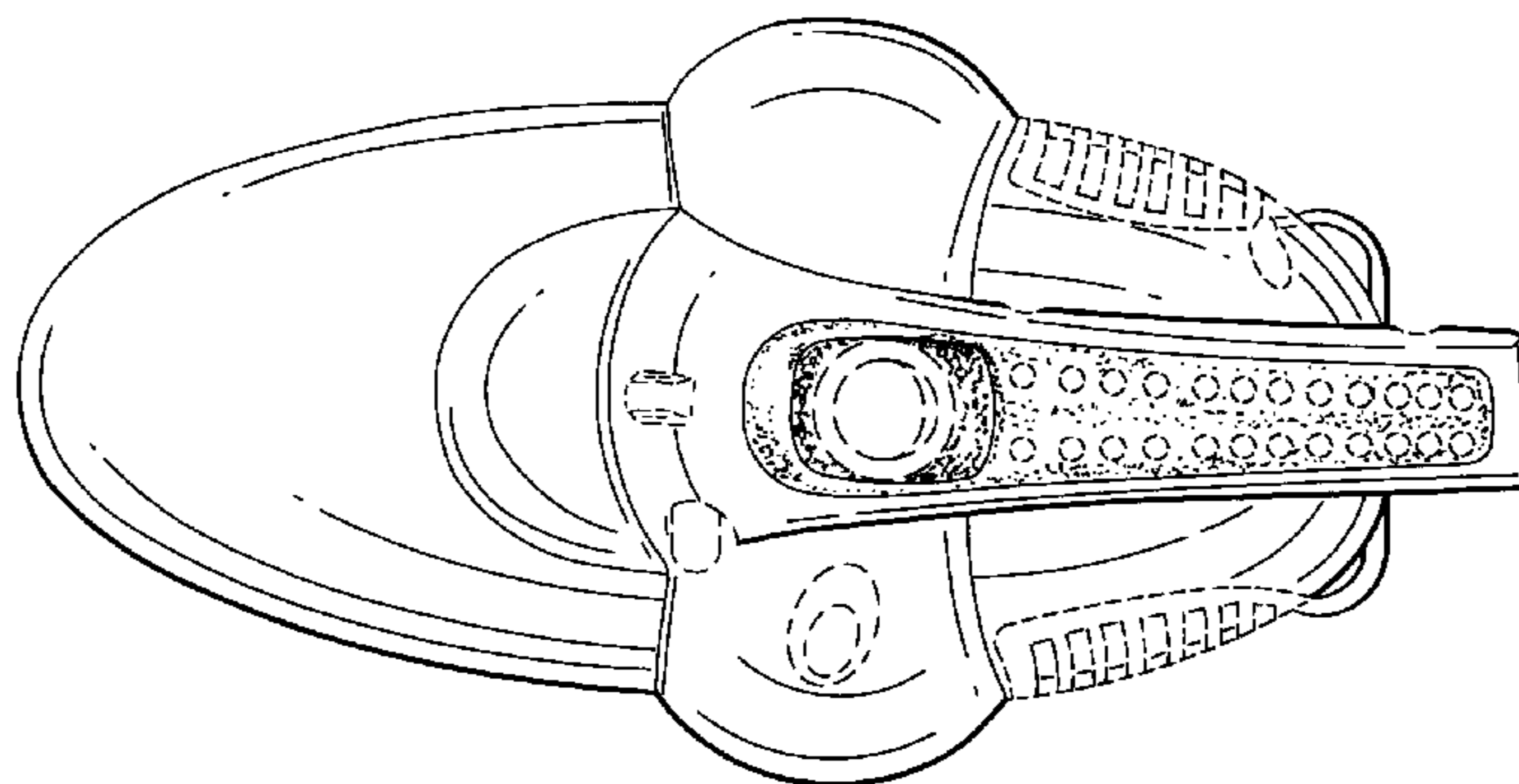
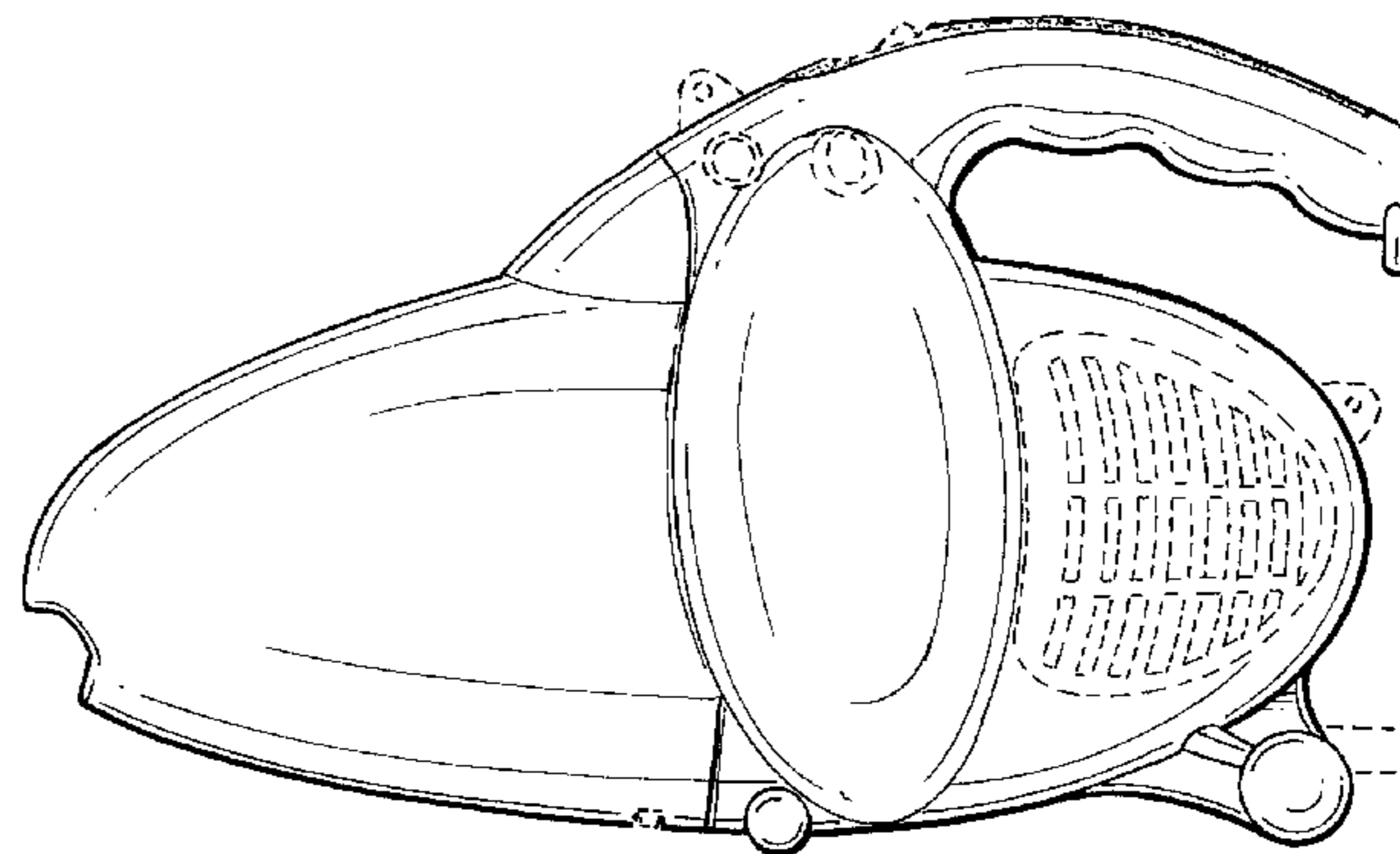
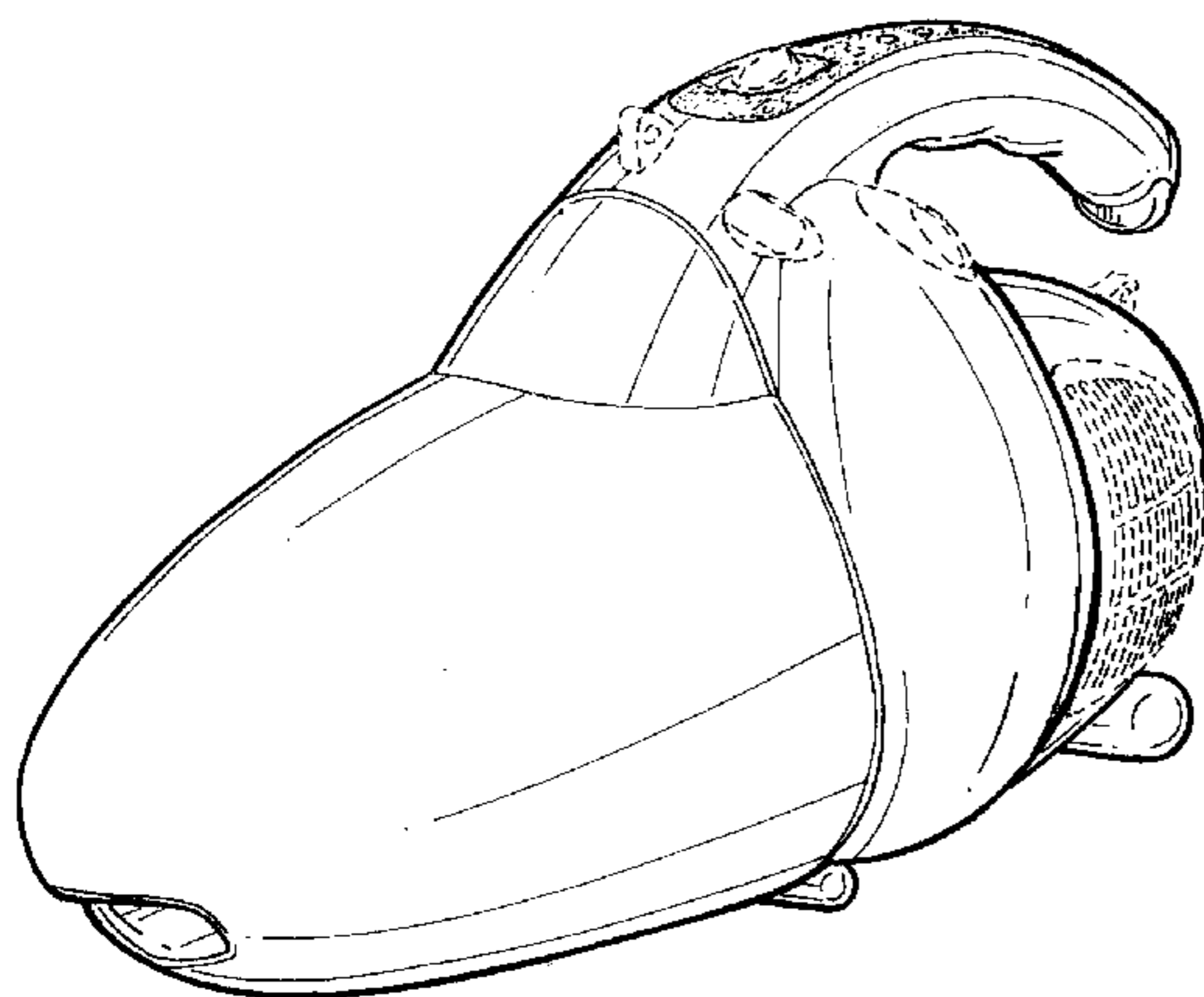

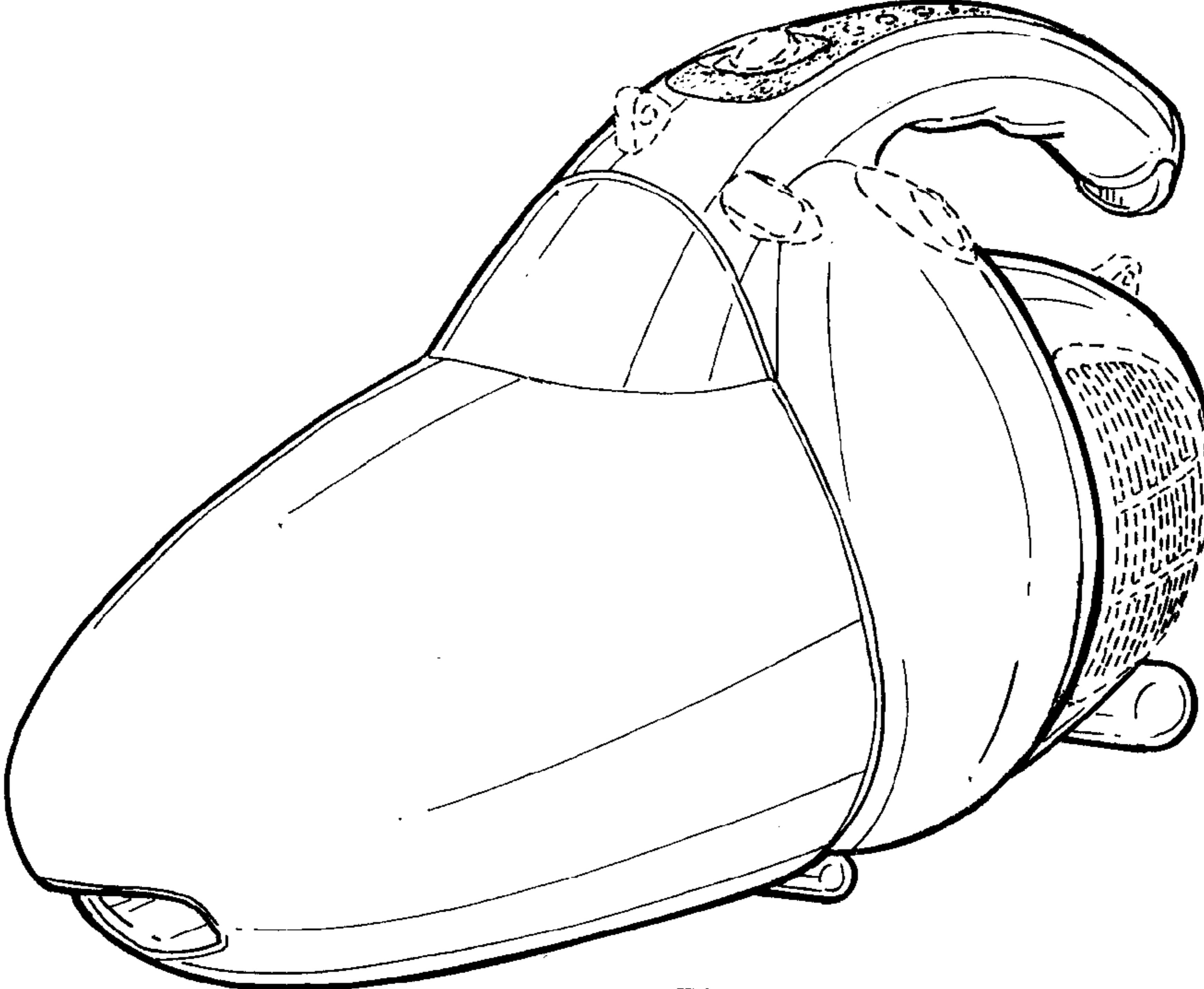

FIG. 1

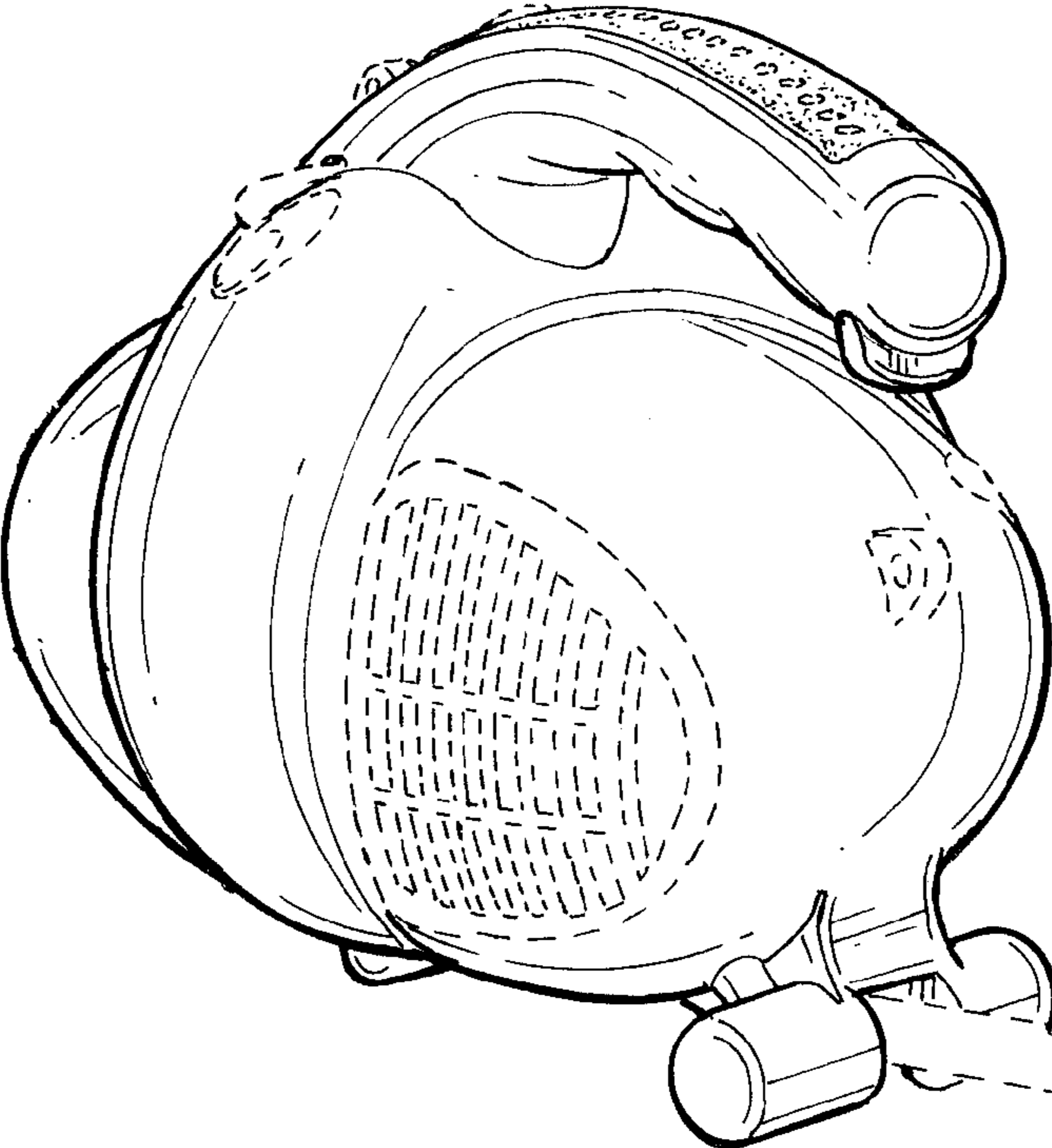

FIG. 2

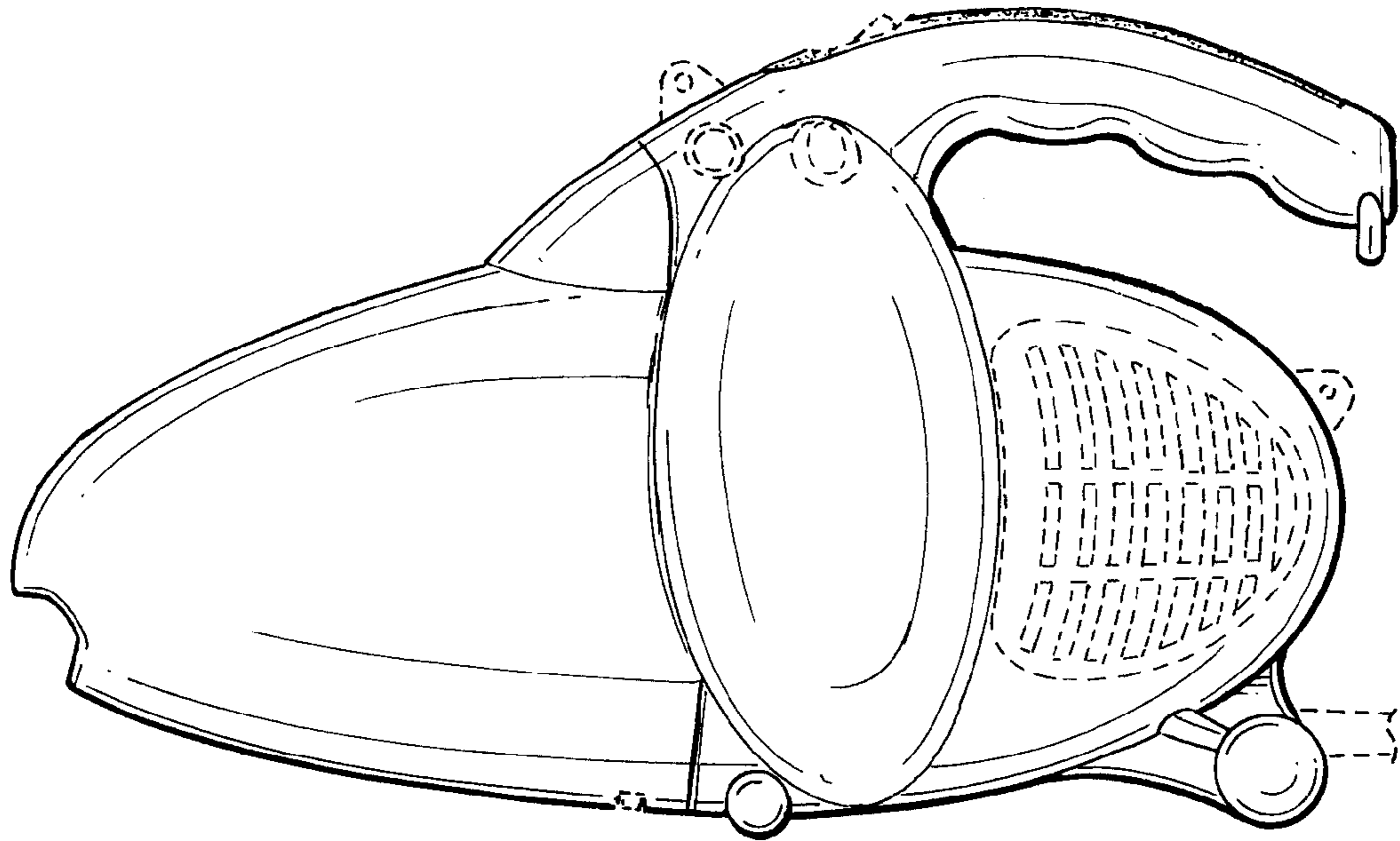

FIG. 3

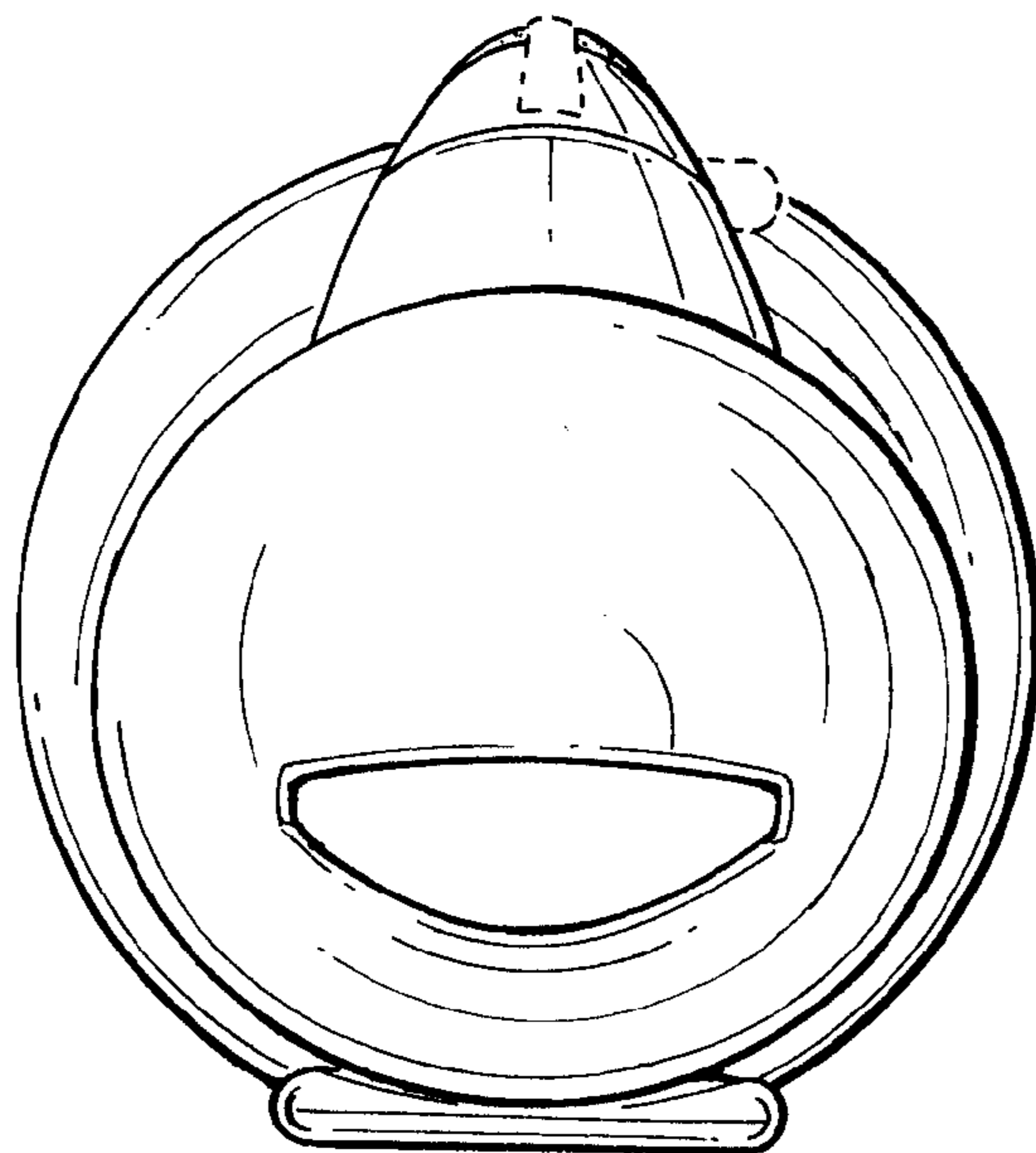

FIG. 4

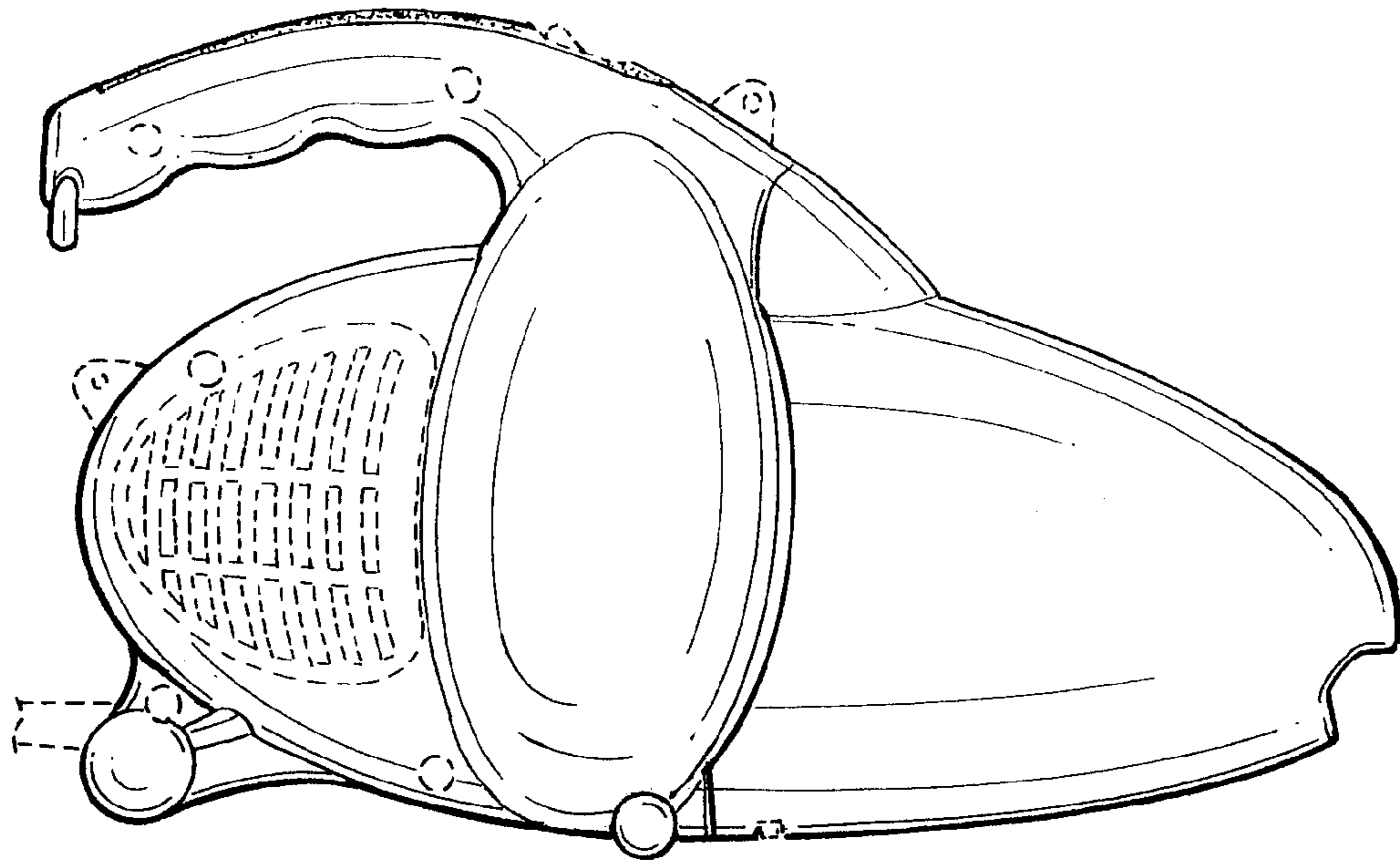

FIG. 5

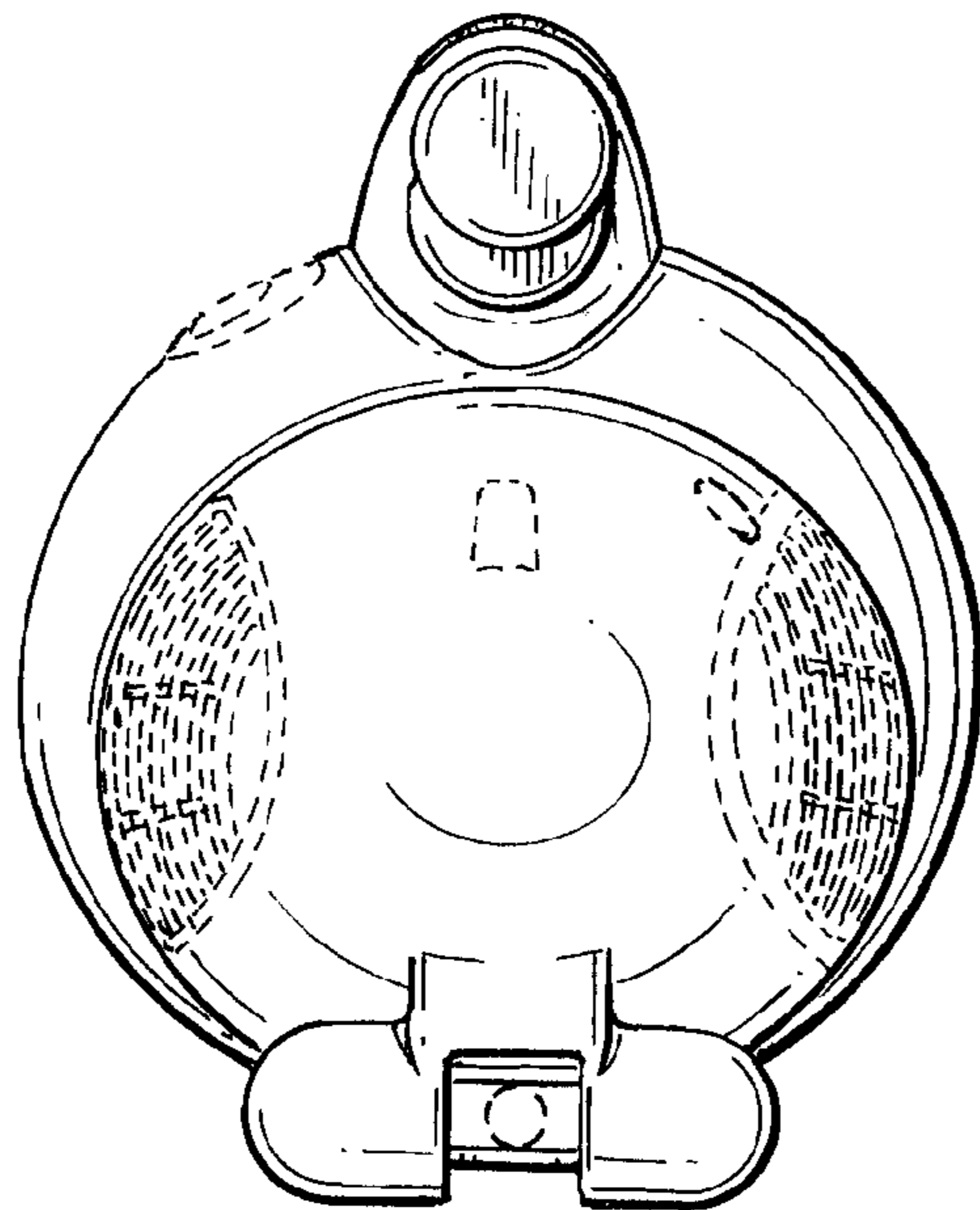

FIG. 6

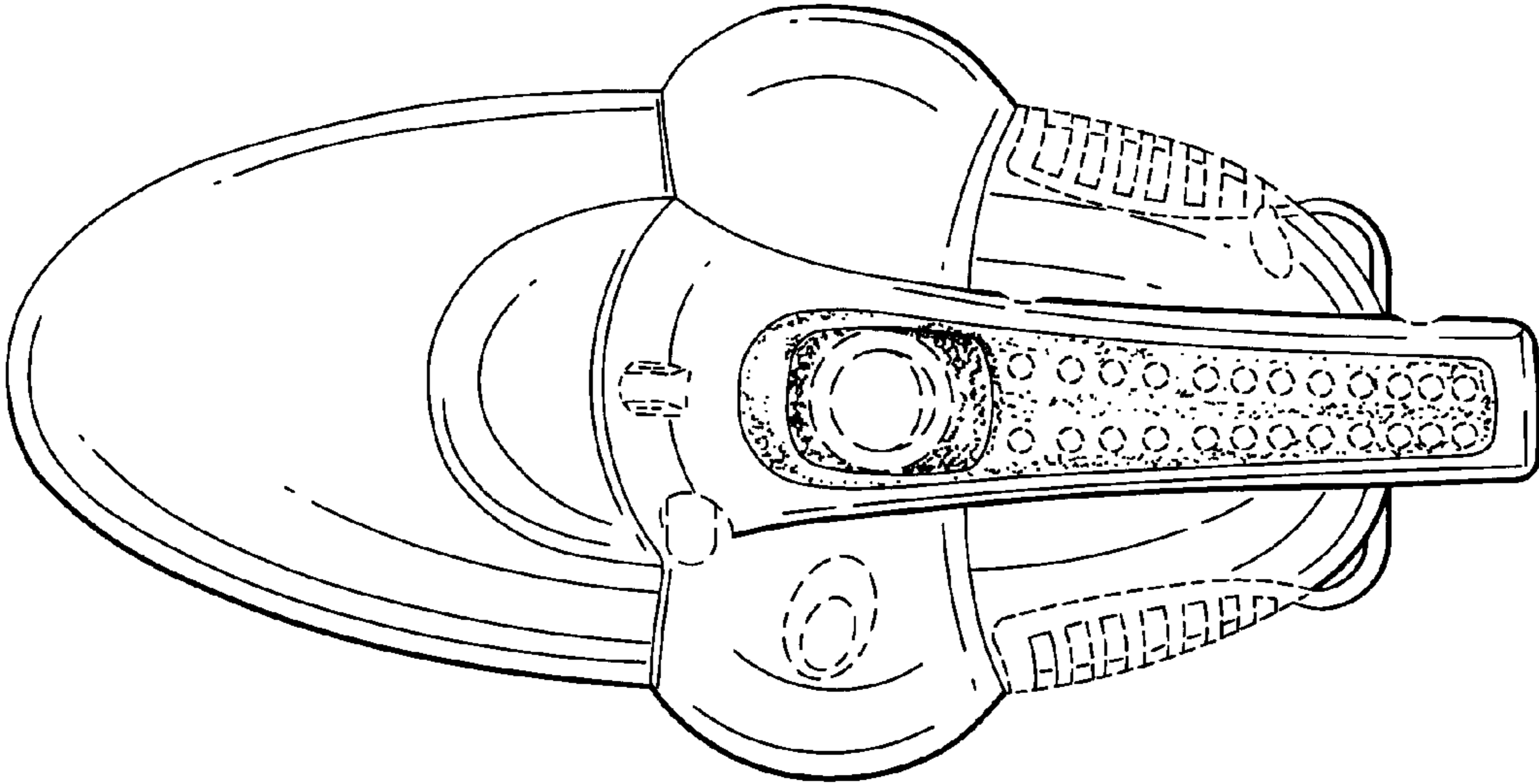

FIG. 7

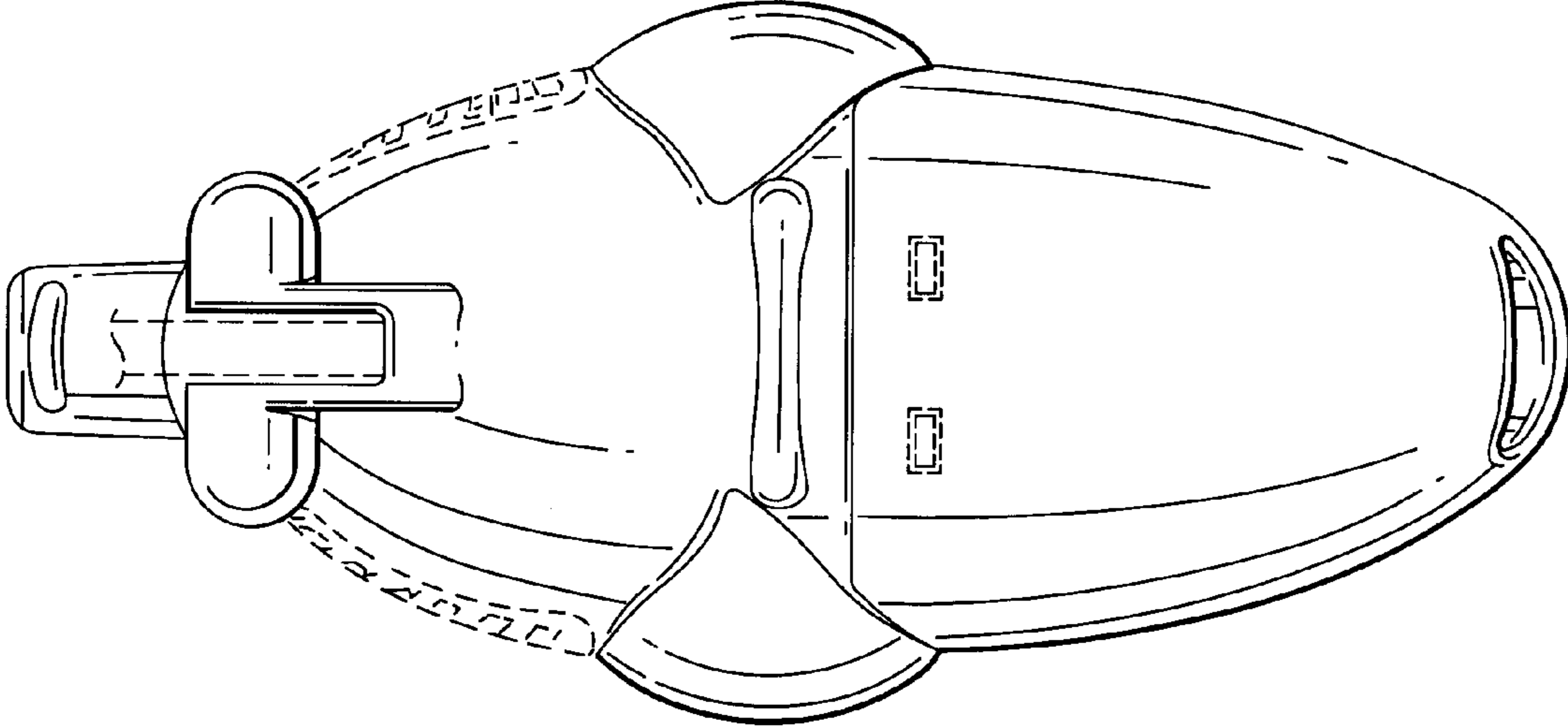

FIG. 8

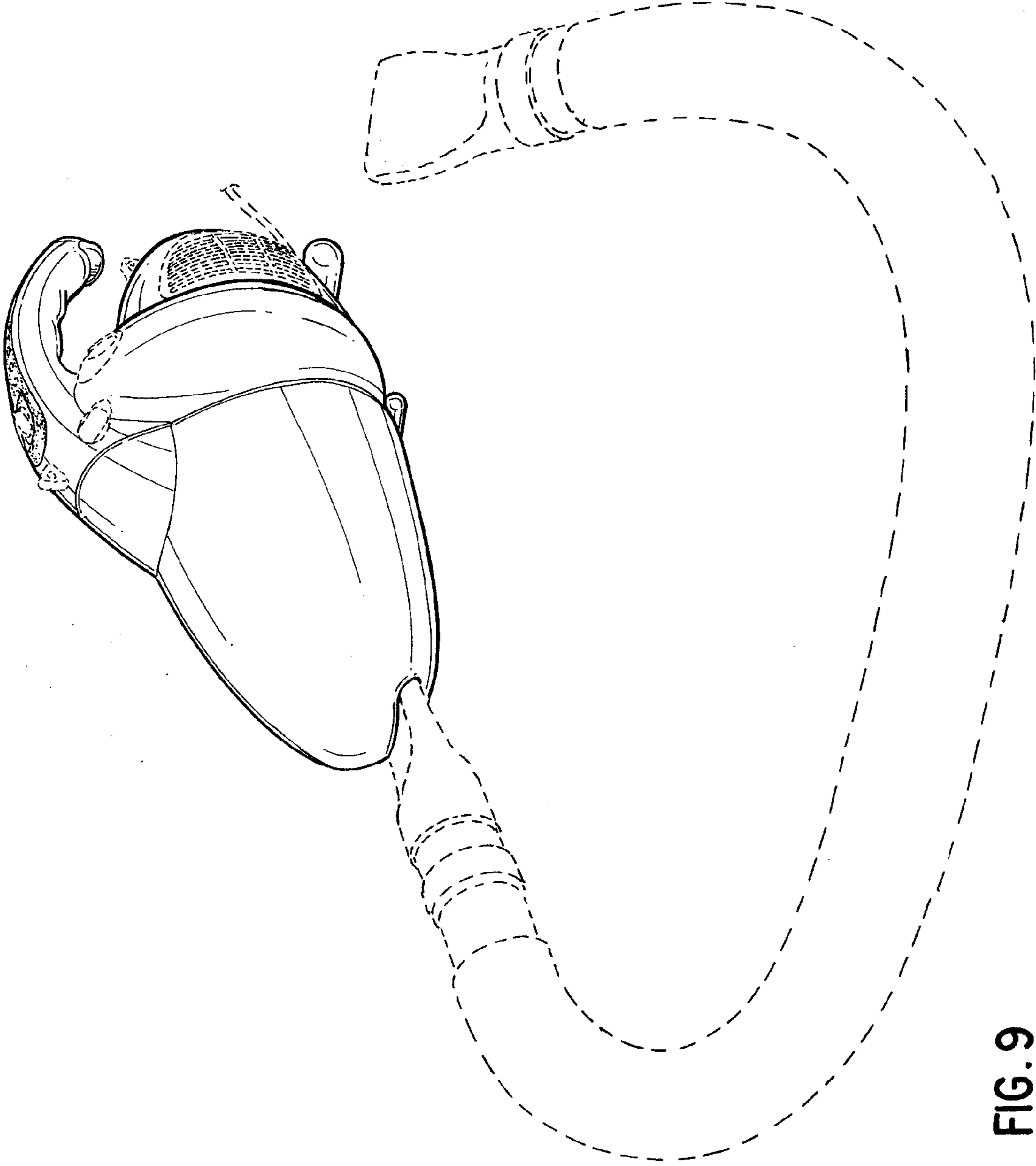

FIG. 9