



US00D515731S

(12) **United States Design Patent**  
**Smith**

(10) **Patent No.:** **US D515,731 S**

(45) **Date of Patent:** **\*\* Feb. 21, 2006**

(54) **LIGHTER**

(75) Inventor: **Andrew D. Smith**, Pascoag, RI (US)

(73) Assignee: **Colibri Corporation**, Providence, RI (US)

(\*\*) Term: **14 Years**

(21) Appl. No.: **29/221,285**

(22) Filed: **Jan. 13, 2005**

(51) **LOC (8) Cl.** ..... **27-05**

(52) **U.S. Cl.** ..... **D27/142; D27/157**

(58) **Field of Classification Search** ..... D27/141,  
D27/142, 143, 148, 152-160; 431/253-256,  
431/273-277, 129, 143, 151-153  
See application file for complete search history.

(56) **References Cited**

**U.S. PATENT DOCUMENTS**

|            |   |         |          |       |         |
|------------|---|---------|----------|-------|---------|
| D291,371 S | * | 8/1987  | Stutzer  | ..... | D27/141 |
| D312,707 S | * | 12/1990 | Demory   | ..... | D27/141 |
| D462,804 S | * | 9/2002  | Maruyama | ..... | D27/155 |
| D504,975 S | * | 5/2005  | Xu       | ..... | D27/142 |

\* cited by examiner

*Primary Examiner*—Jennifer Rivard  
(74) *Attorney, Agent, or Firm*—Salter & Michaelson

(57) **CLAIM**

The ornamental design for a lighter, as shown and described.

**DESCRIPTION**

FIG. 1 is a perspective view of a lighter showing my new design;

FIG. 2 is a right side elevational view thereof;

FIG. 3 is a left side elevational view thereof;

FIG. 4 is a top plan view thereof;

FIG. 5 is a bottom plan view thereof;

FIG. 6 is a front elevational view thereof;

FIG. 7 is a rear elevational view thereof; and,

FIG. 8 is a right side elevational view showing the cover and the clip member in their opened positions.

The portions shown in broken lines in FIG. 8 are included for illustrative purposes only and form no part of the claimed design.

**1 Claim, 4 Drawing Sheets**

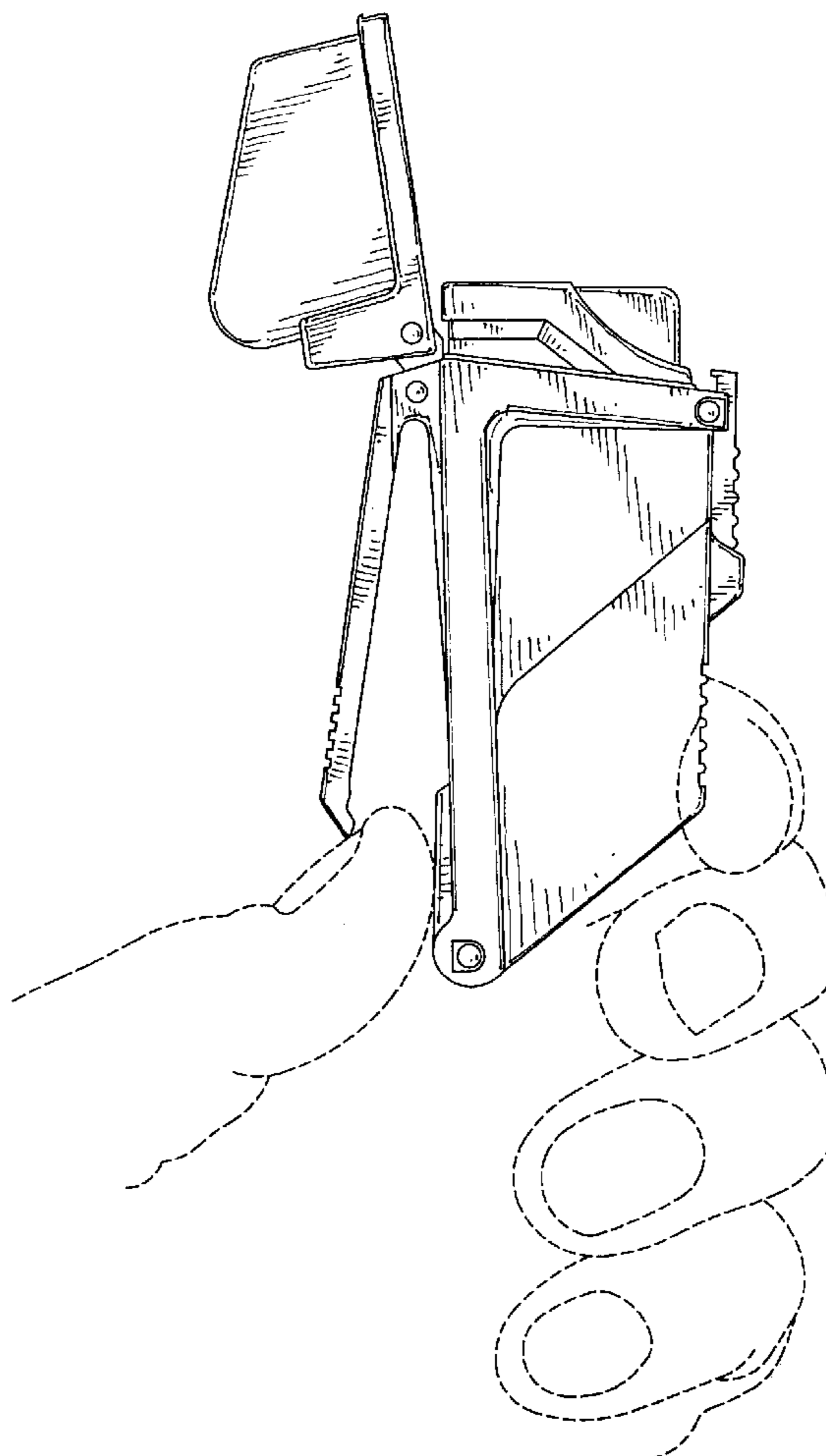
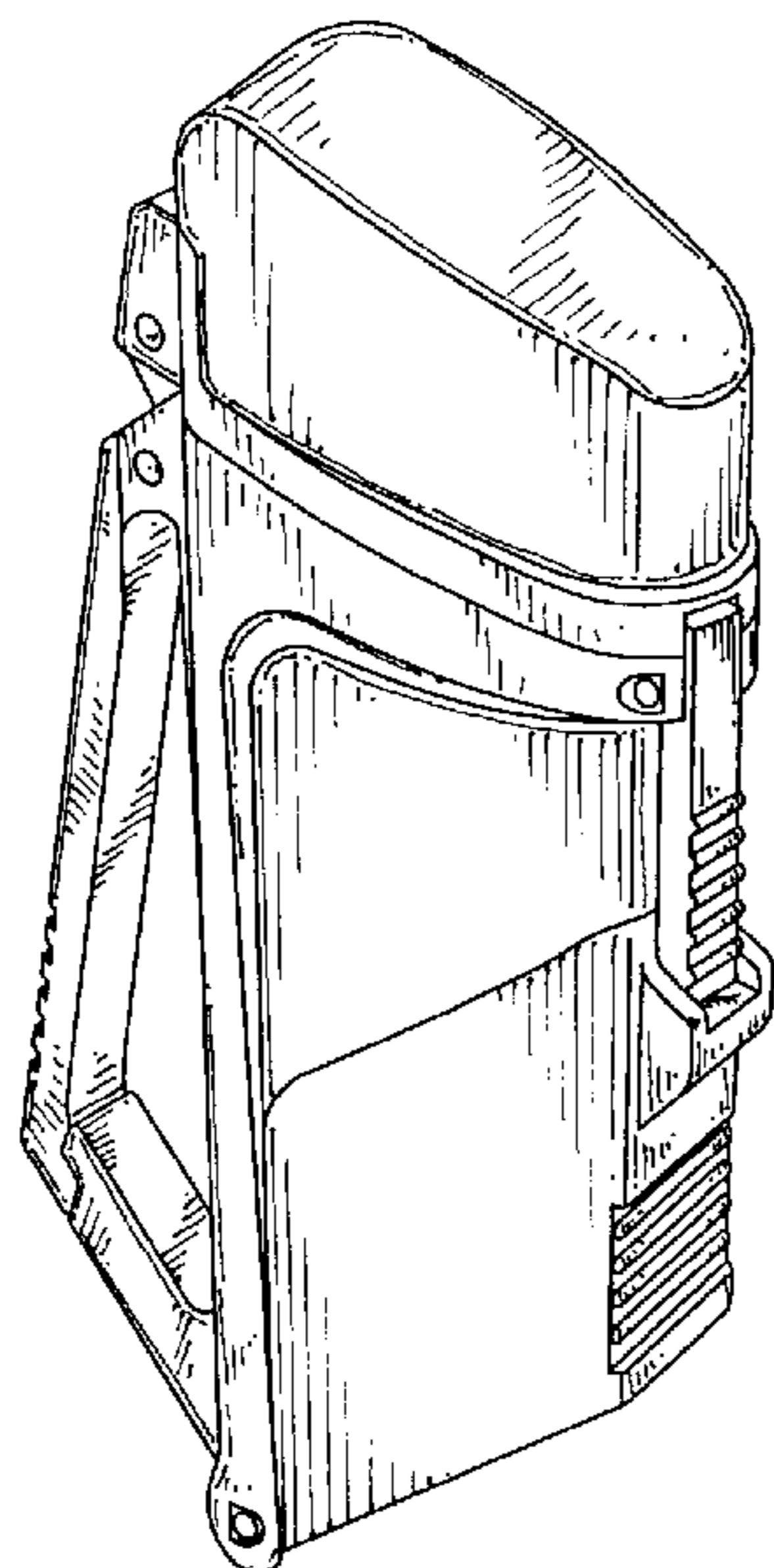

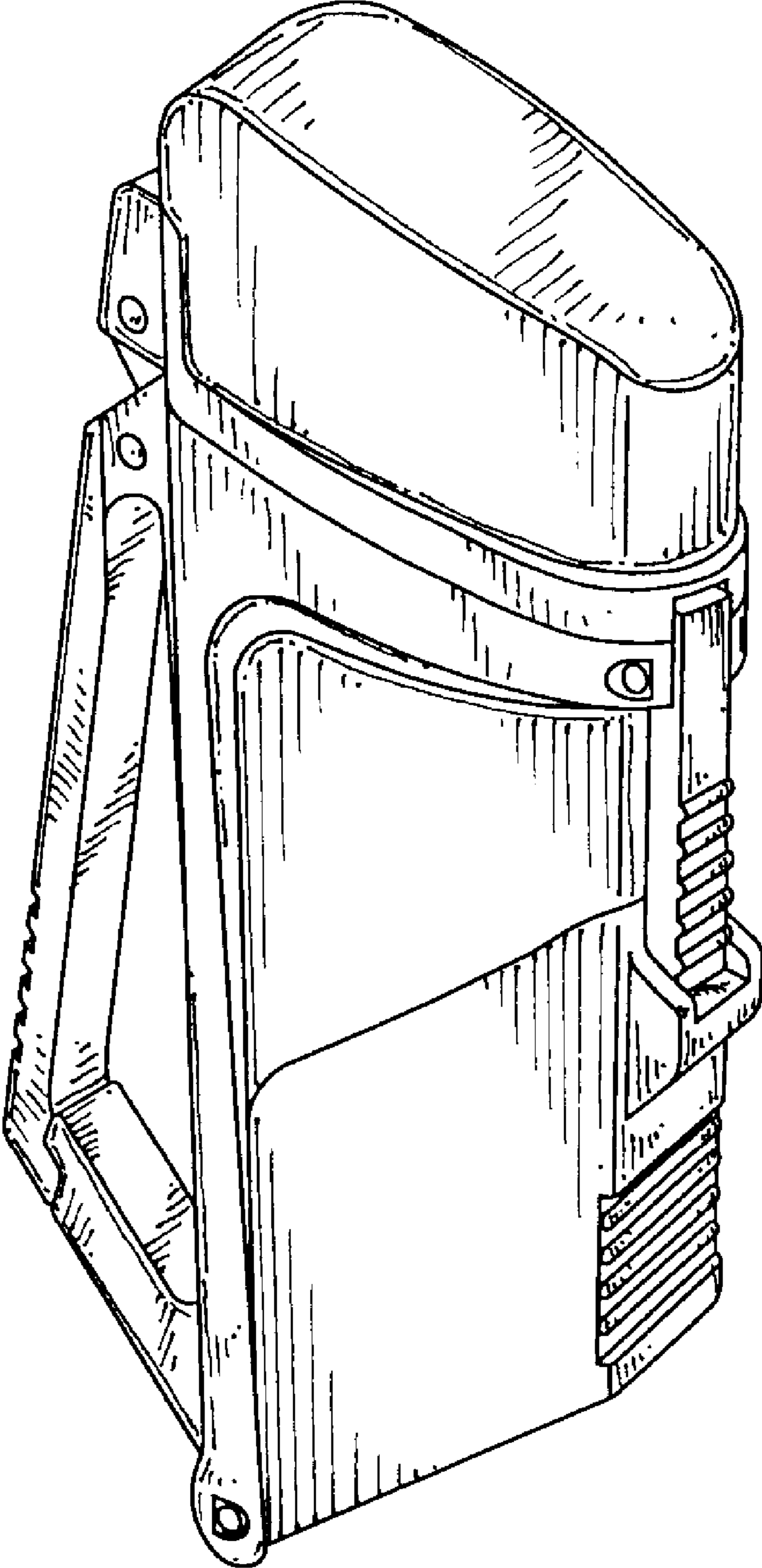

FIG. 1

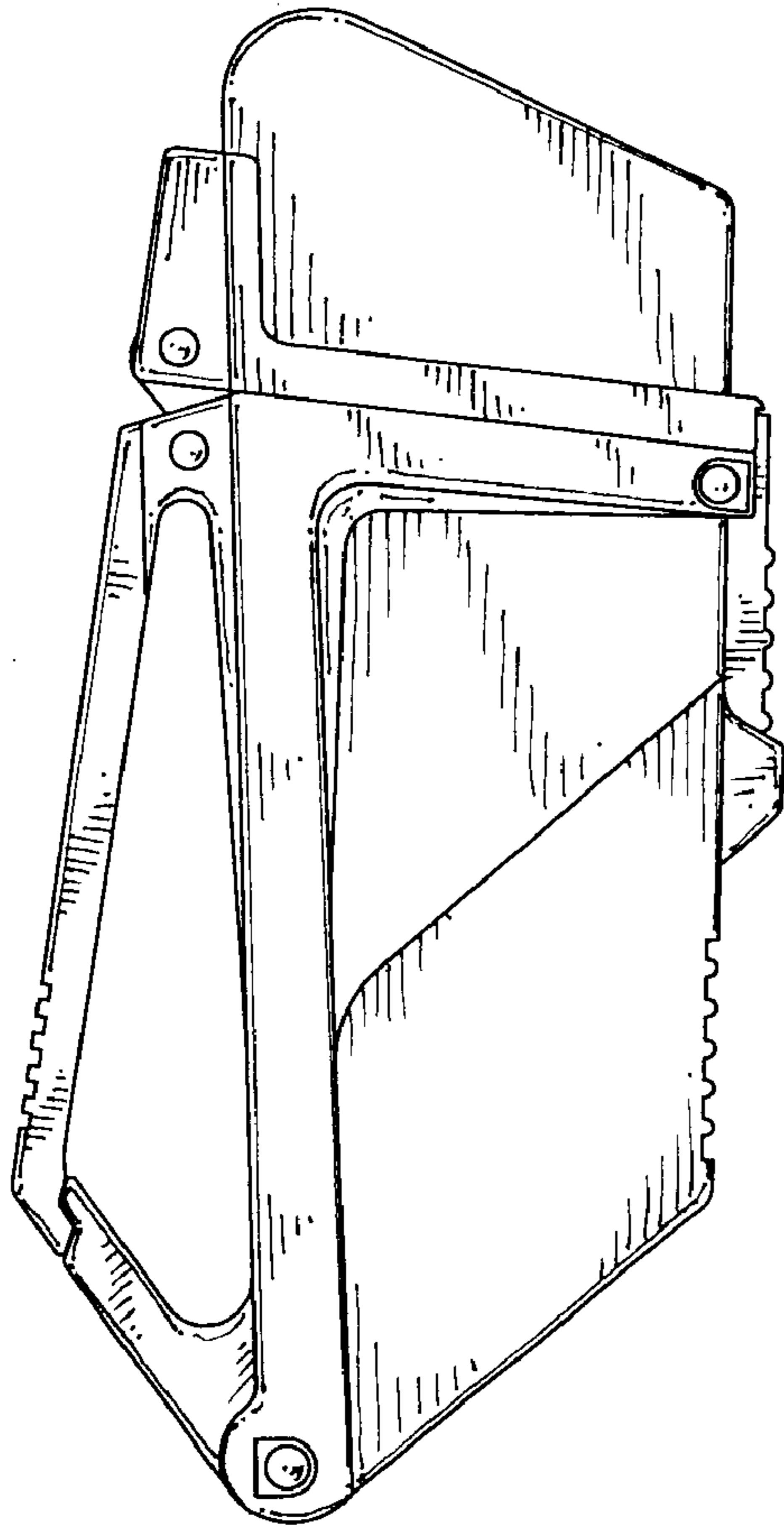

FIG. 2

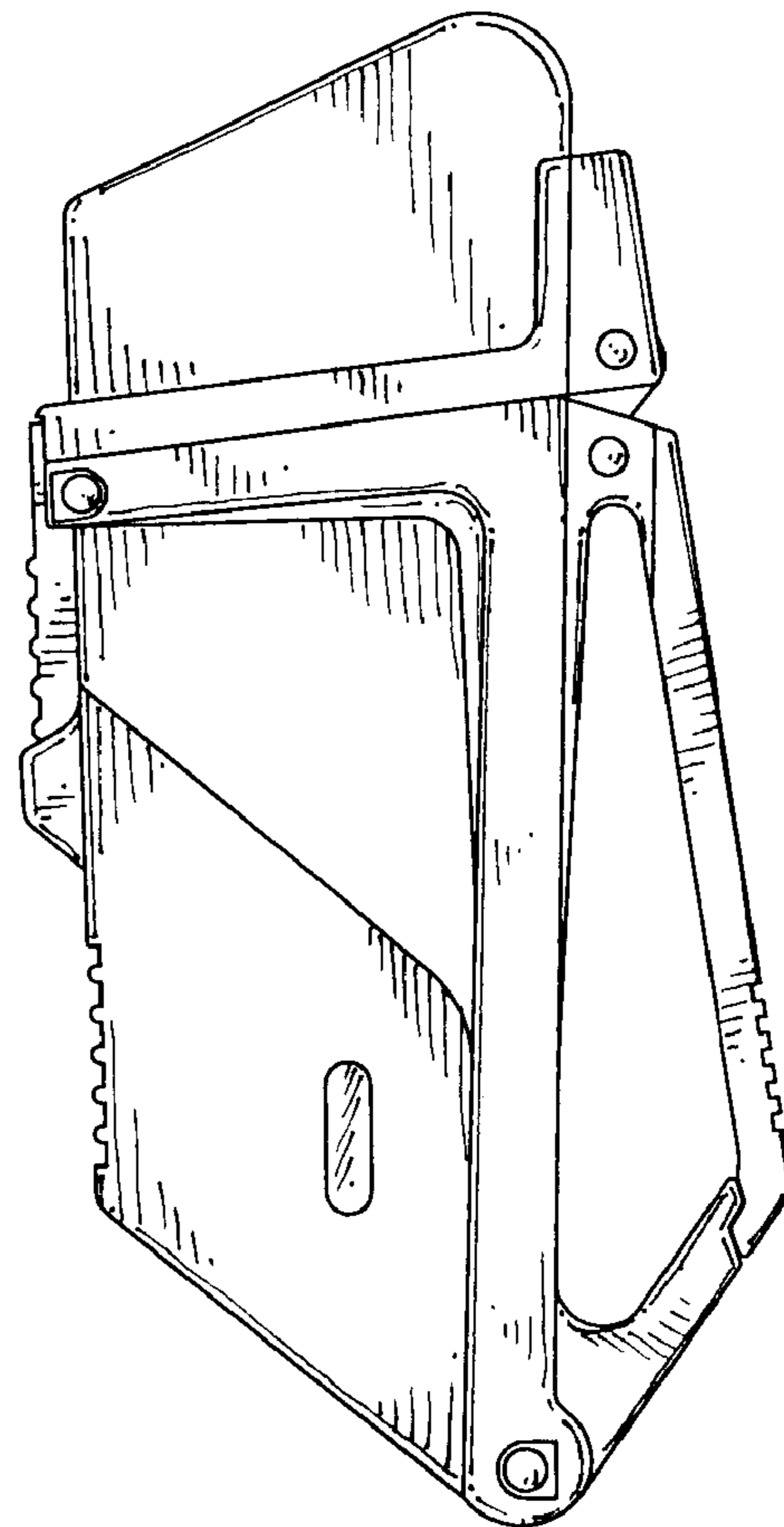

FIG. 3

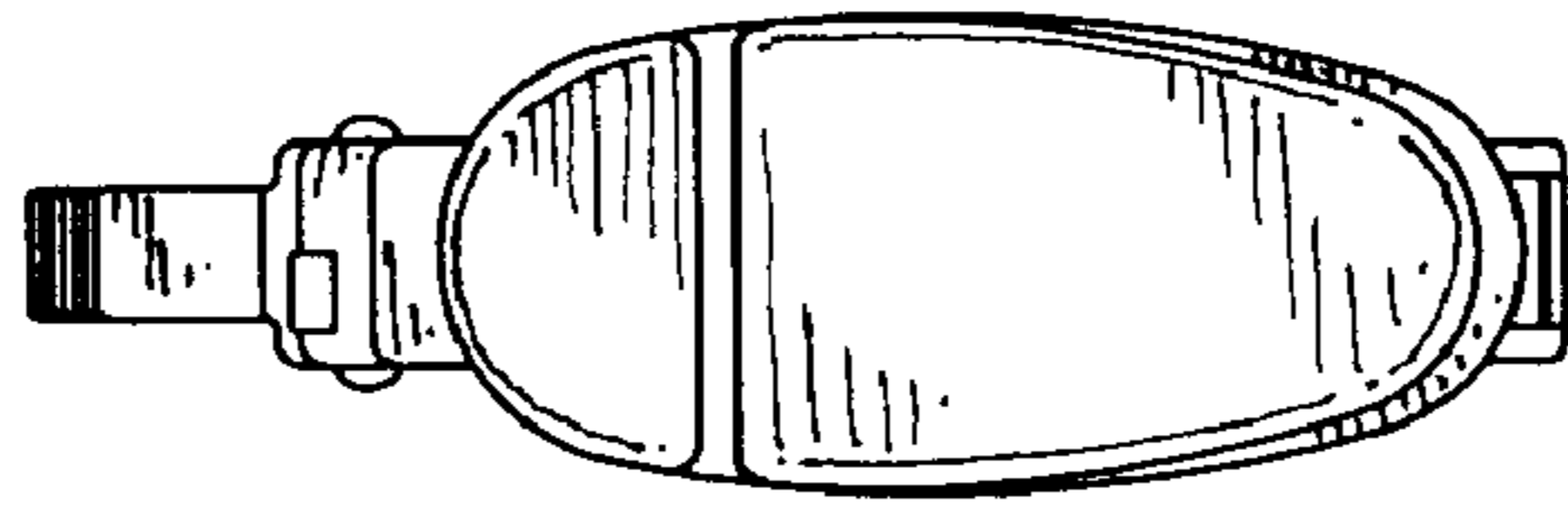

FIG. 4

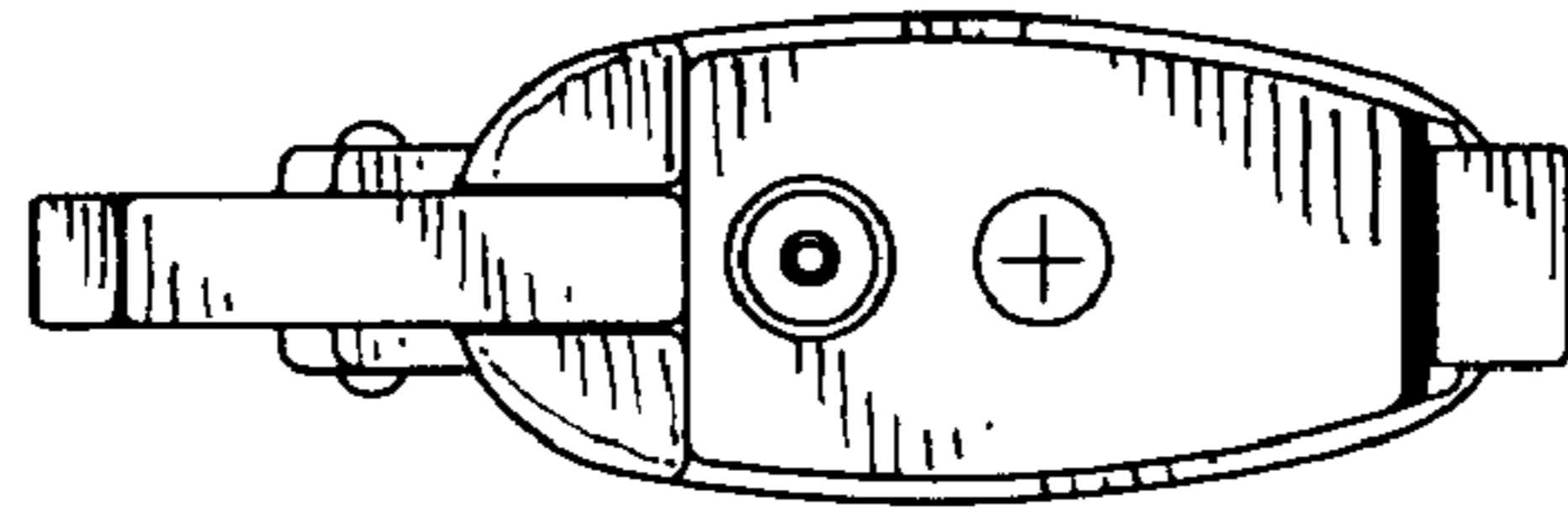

FIG. 5

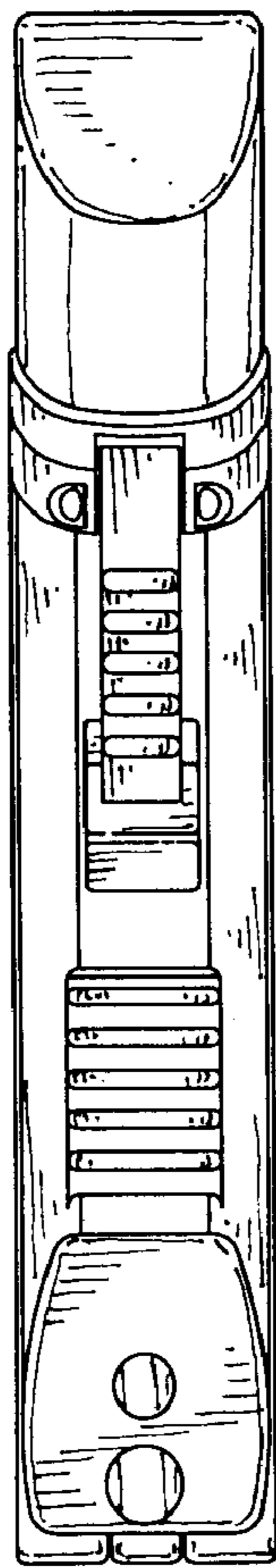

FIG. 6

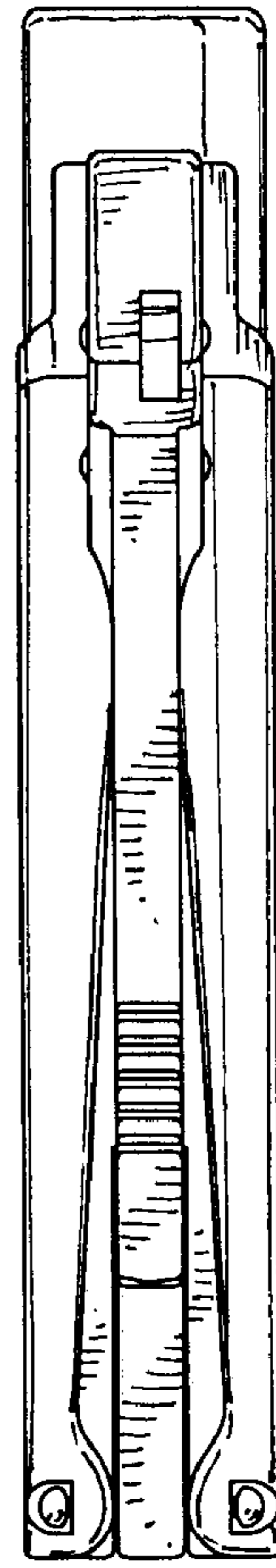

FIG. 7

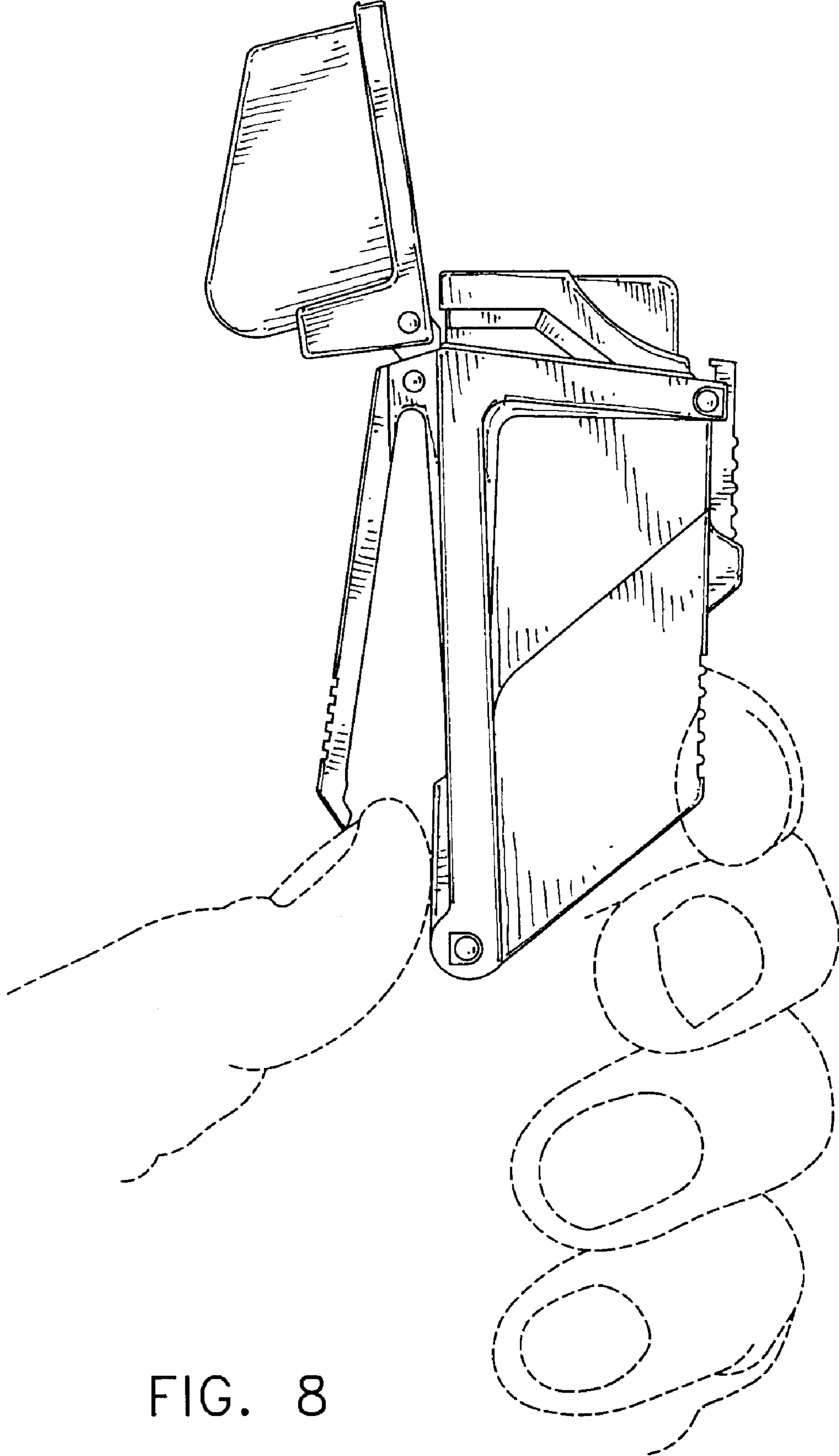

FIG. 8