



US00D515719S

(12) **United States Design Patent**
Shiu

(10) **Patent No.:** **US D515,719 S**
(45) **Date of Patent:** **** Feb. 21, 2006**

(54) **TORCH**

(75) Inventor: **Wai Lin Shiu**, Hong Kong (CN)

(73) Assignee: **Ascent Fair (Hong Kong) Limited**,
Hong Kong (CN)

(**) Term: **14 Years**

(21) Appl. No.: **29/211,405**

(22) Filed: **Aug. 16, 2004**

(30) **Foreign Application Priority Data**

Mar. 30, 2004 (CN) 2004300069216

(51) **LOC (8) Cl.** **26-02**

(52) **U.S. Cl.** **D26/37**

(58) **Field of Classification Search** D26/37-50;
362/157, 158, 171-174, 183-208
See application file for complete search history.

(56) **References Cited**

U.S. PATENT DOCUMENTS

D429,830 S * 8/2000 Ting D26/37

D501,055 S * 1/2005 Packard D26/37

* cited by examiner

Primary Examiner—Marcus A. Jackson

(74) *Attorney, Agent, or Firm*—RatnerPrestia

(57) **CLAIM**

The ornamental design for a torch, as shown and described.

DESCRIPTION

FIG. 1 is a front view of a torch according to the present design;

FIG. 2 is a rear view of a torch according to the present design;

FIG. 3 is a left view of a torch according to the present design;

FIG. 4 is a right view of a torch according to the present design;

FIG. 5 is a top view of a torch according to the present design;

FIG. 6 is a bottom view of a torch according to the present design; and,

FIG. 7 is a perspective view of a torch according to the present design.

1 Claim, 4 Drawing Sheets

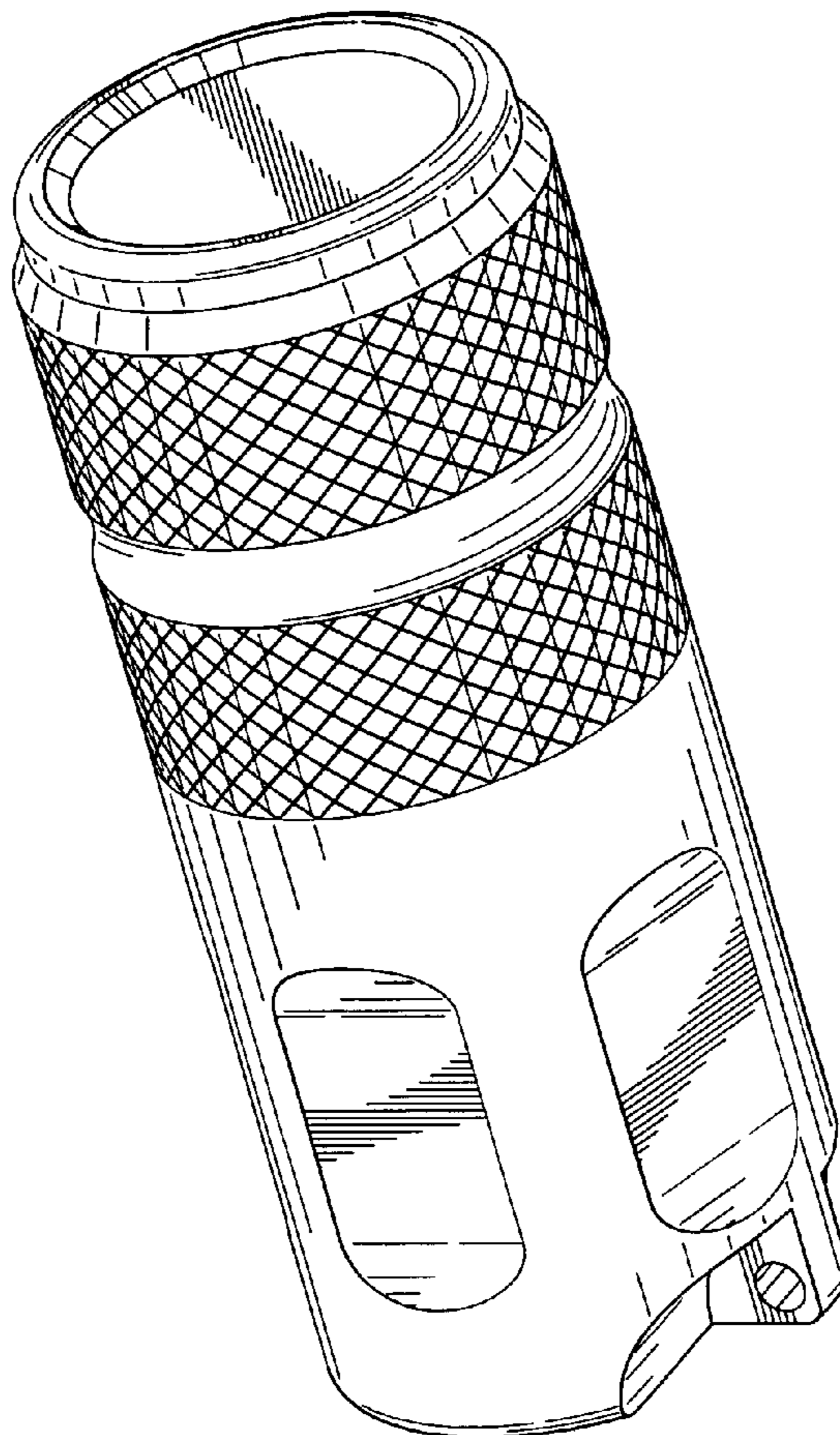

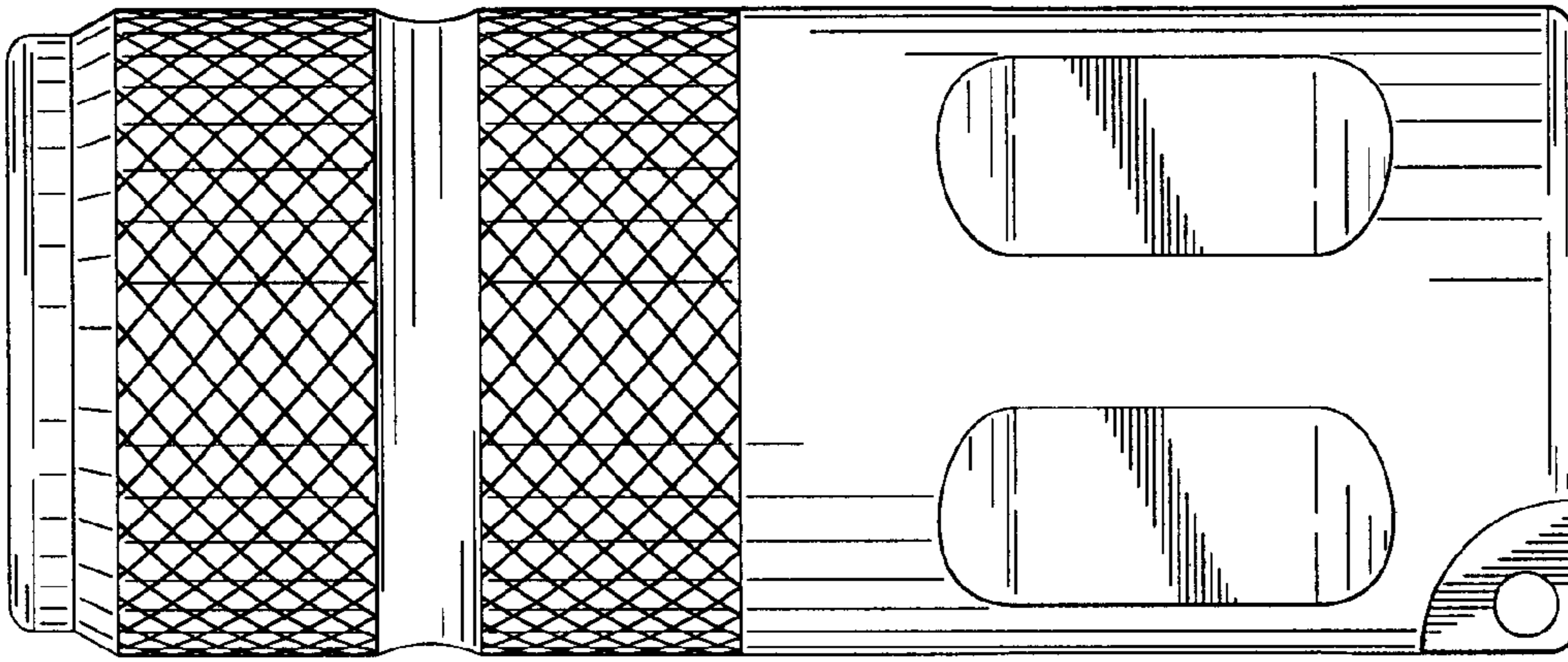

FIG. 1

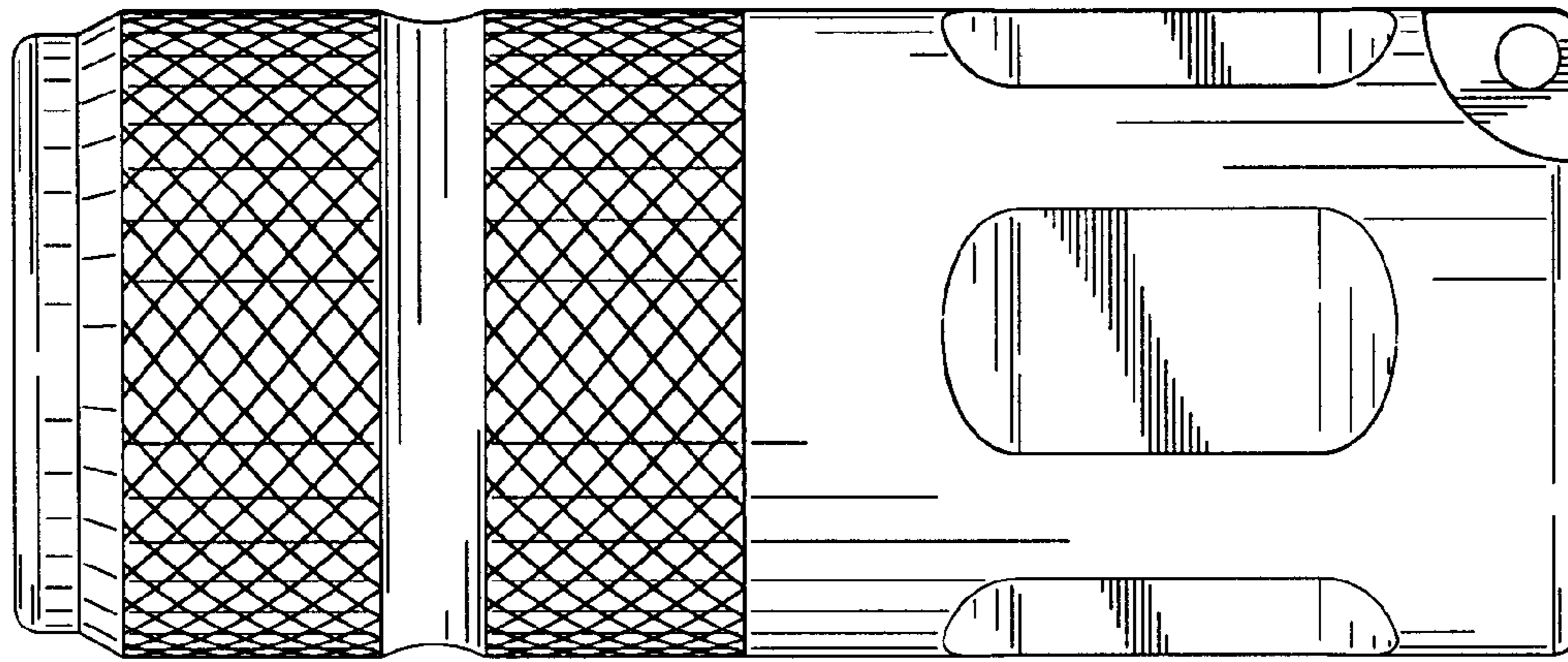

FIG. 2

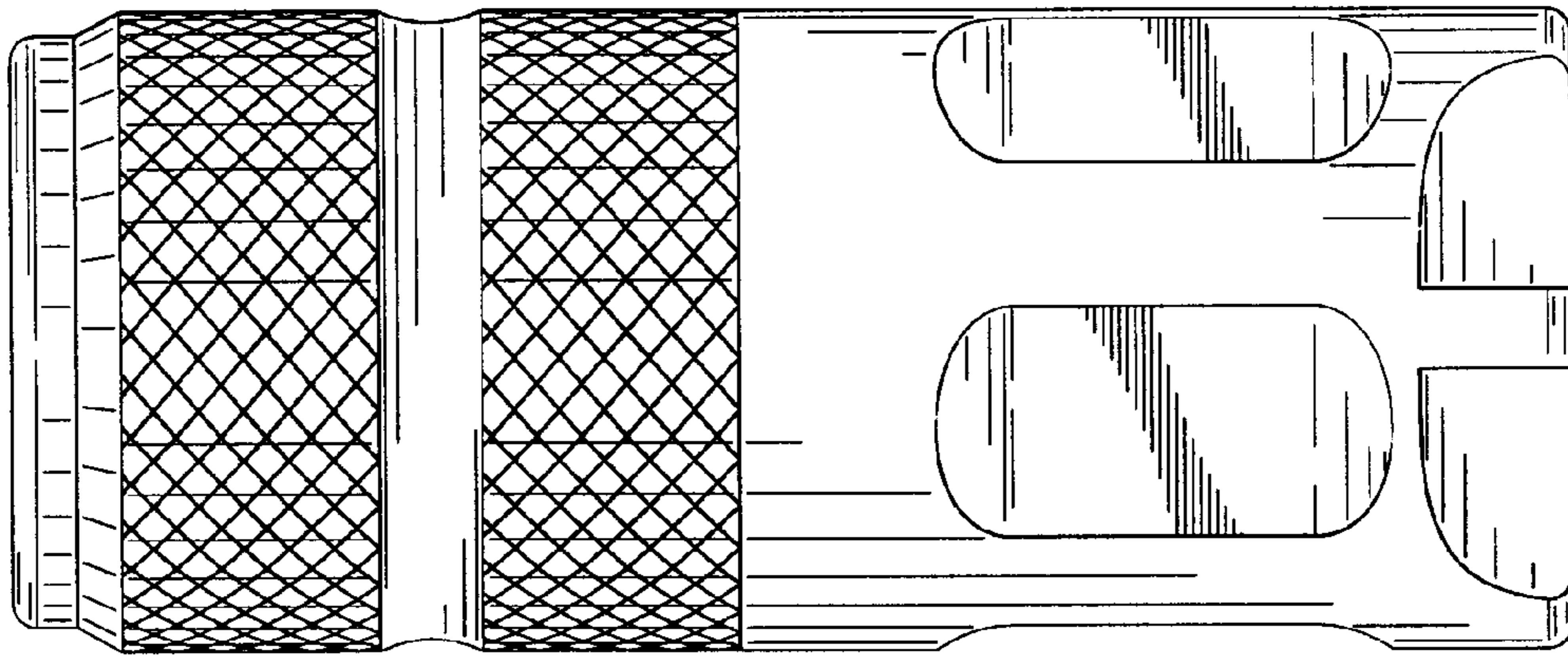

FIG. 3

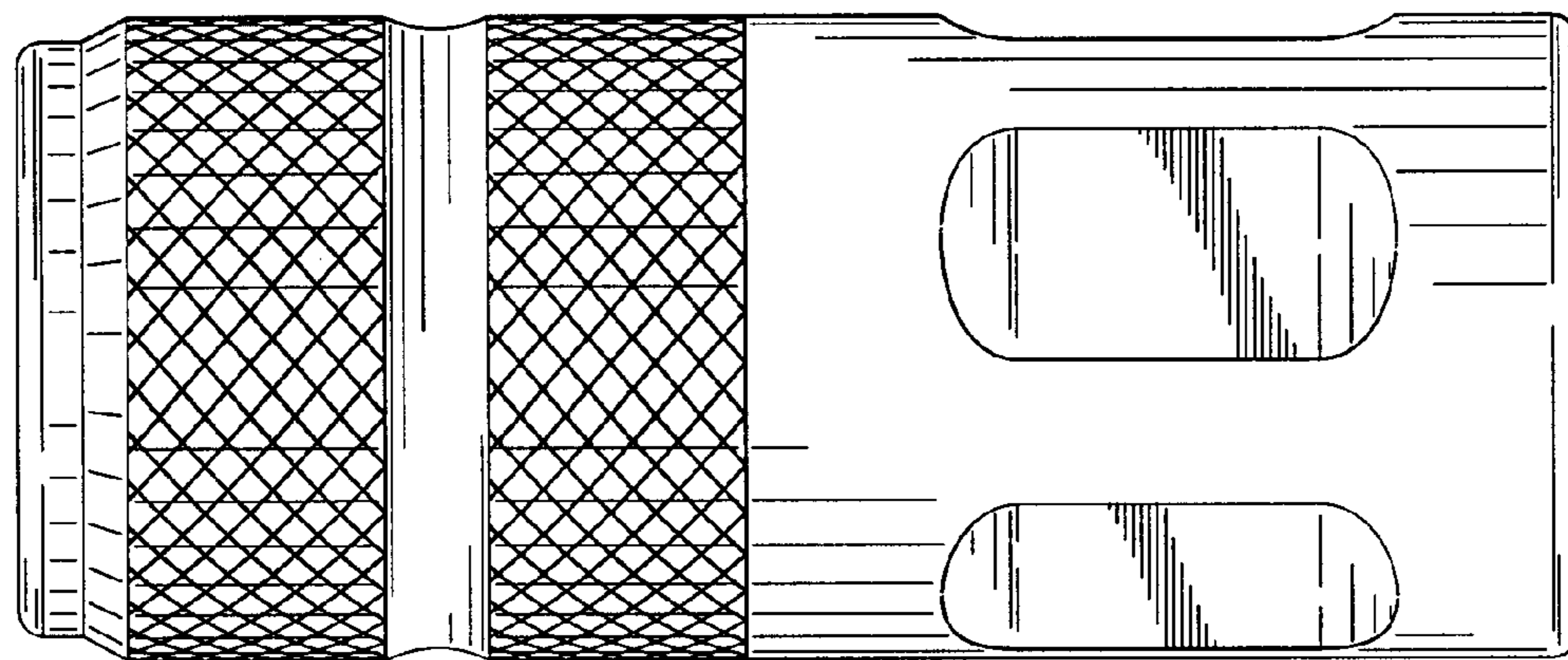

FIG. 4

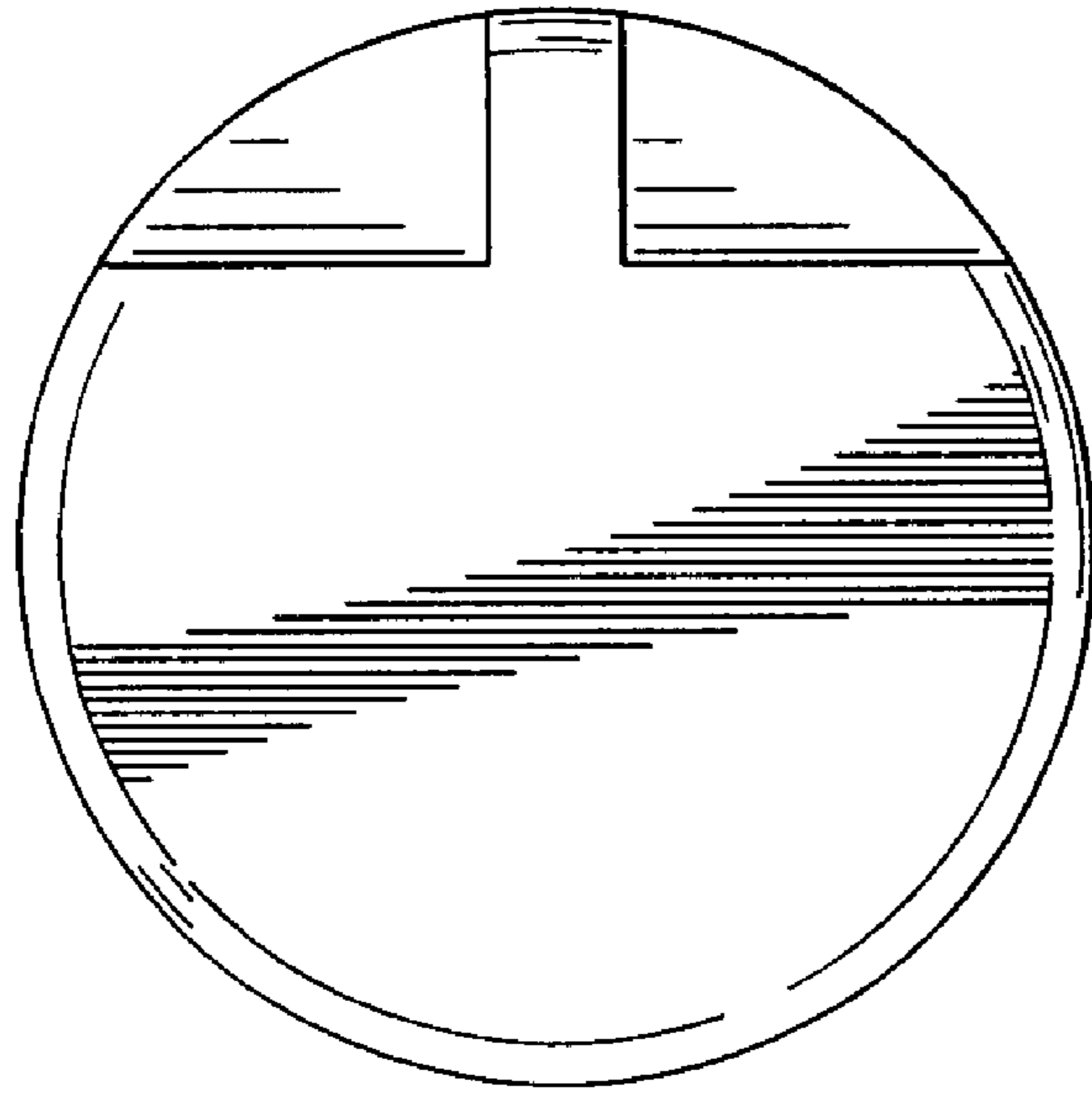

FIG. 6

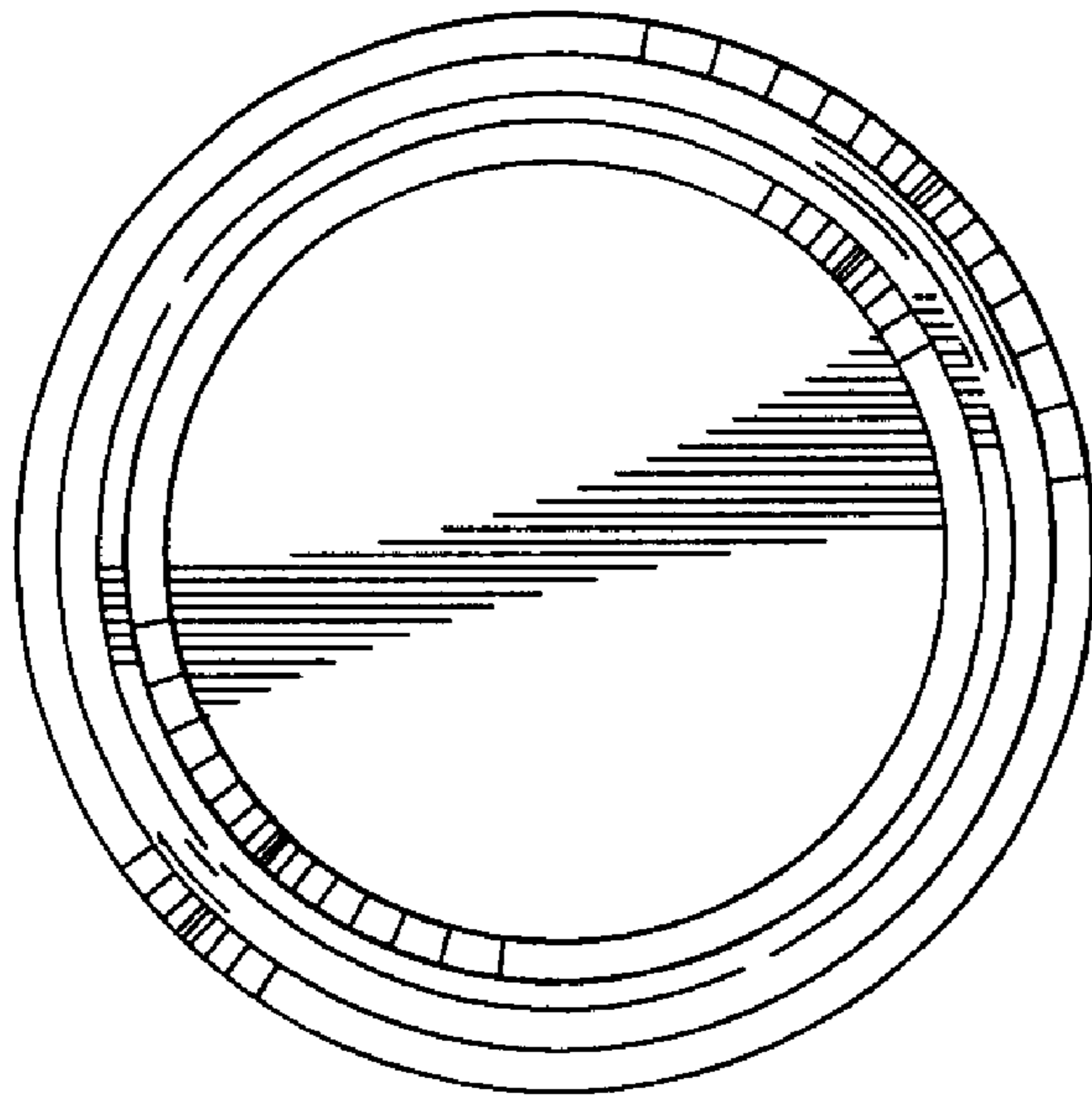

FIG. 5

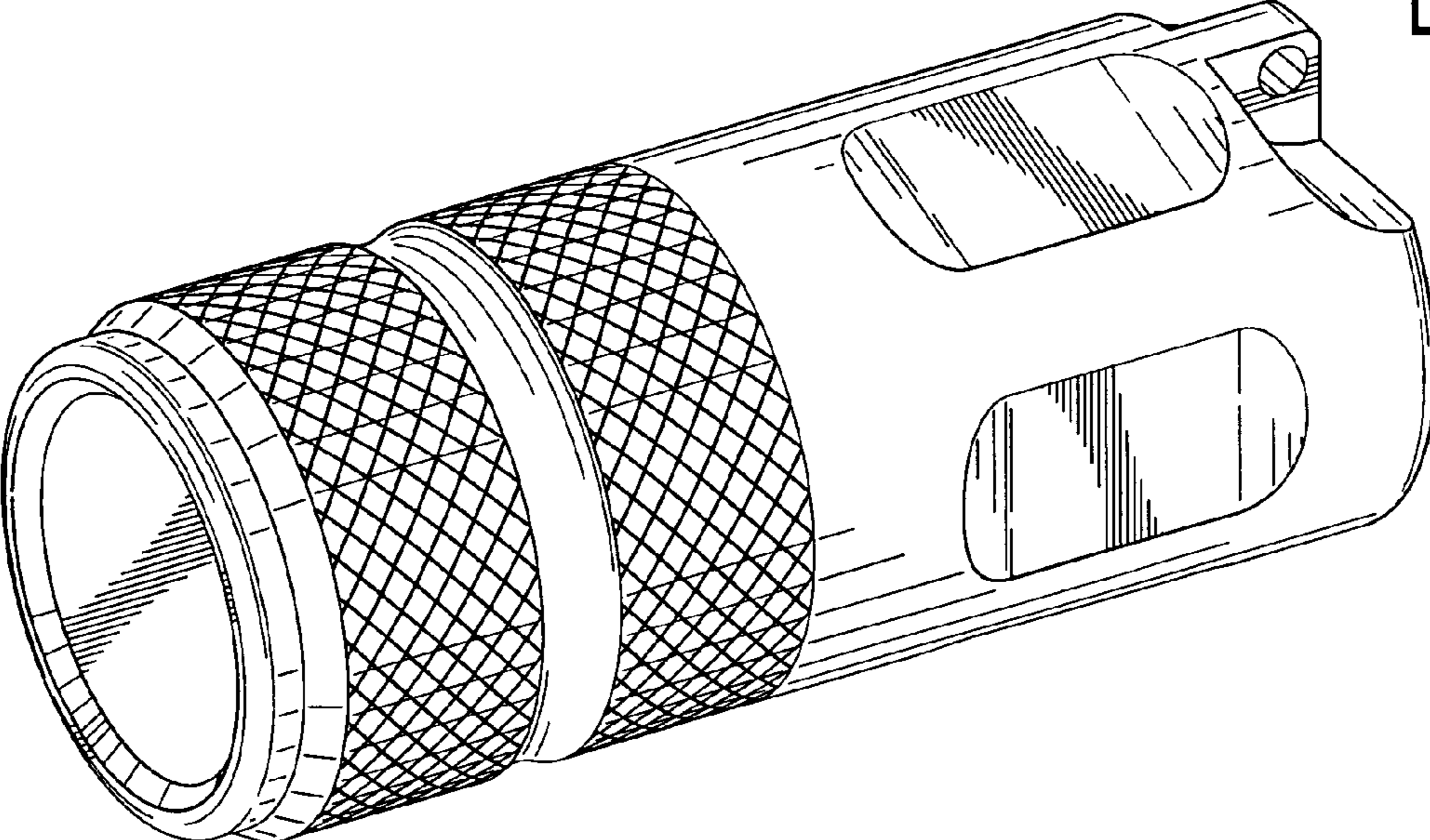

FIG. 7