



US00D515544S

(12) **United States Design Patent**
Kim et al.

(10) **Patent No.:** **US D515,544 S**
(45) **Date of Patent:** **** Feb. 21, 2006**

(54) **PORTABLE TELEPHONE**

(75) Inventors: **Young-Sae Kim**, Los Altos, CA (US);
Chang-Hwan Hwang, Kyungki-Do
(KR)

(73) Assignee: **Samsung Electronics Co., Ltd.**,
Suwon-Si (KR)

(**) **Term:** **14 Years**

(21) **Appl. No.:** **29/220,278**

(22) **Filed:** **Dec. 29, 2004**

(30) **Foreign Application Priority Data**

Jul. 30, 2004 (KR) 30-2004-0023397

(51) **LOC (8) Cl.** **14-03**

(52) **U.S. Cl.** **D14/138**

(58) **Field of Classification Search** D14/137,
D14/138, 147-148, 247-248, 144, 341-347;
379/433.01-433.13, 434; 455/575.1, 566,
455/556.1; D21/517

See application file for complete search history.

(56) **References Cited**

U.S. PATENT DOCUMENTS

D402,572 S	*	12/1998	Han	D10/65
D451,079 S	*	11/2001	Ali	D14/138
D454,849 S	*	3/2002	Eckholm	D14/138
D456,794 S	*	5/2002	Laverick et al.	D14/138
D464,645 S	*	10/2002	O'Neil	D14/248
D469,748 S	*	2/2003	Ribeiro et al.	D14/138
D478,882 S	*	8/2003	Peng et al.	D14/138
D479,216 S	*	9/2003	Ho-Cheun et al.	D14/138
D484,477 S	*	12/2003	Salmi	D14/138
D485,819 S	*	1/2004	Ahlgren	D14/138
D486,458 S	*	2/2004	Chen et al.	D14/138
D488,143 S	*	4/2004	Ting et al.	D14/138
D490,788 S	*	6/2004	Chang	D14/138
D492,276 S	*	6/2004	Walliser et al.	D14/138
D492,657 S	*	7/2004	Jensfelt	D14/138
D492,659 S	*	7/2004	Medeiros et al.	D14/138
D492,660 S	*	7/2004	Kim et al.	D14/138

D494,949 S	*	8/2004	Arnholt et al.	D14/138
D495,307 S	*	8/2004	Yau et al.	D14/138
D496,921 S	*	10/2004	Hwang	D14/138
D502,157 S	*	2/2005	Kim et al.	D14/138
D502,455 S	*	3/2005	Brandis et al.	D14/138
D502,933 S	*	3/2005	Munstermann	D14/138
D506,190 S	*	6/2005	Mehandjiysky	D14/138
2001/0040964 A1	*	11/2001	Deguchi	379/433.01
2003/0064751 A1	*	4/2003	Charlier et al.	455/557
2003/0114198 A1	*	6/2003	Han	455/566
2003/0203747 A1	*	10/2003	Nagamine	455/575.3
2003/0223576 A1	*	12/2003	Totani	379/433.04
2004/0192398 A1	*	9/2004	Zhu	455/566
2004/0204025 A1	*	10/2004	Siddiqui	455/550.1
2004/0224732 A1	*	11/2004	Lee et al.	455/575.3
2005/0014537 A1	*	1/2005	Gammon et al.	455/575.1

FOREIGN PATENT DOCUMENTS

WO DM/058233 * 12/2001

* cited by examiner

Primary Examiner—Jeffrey Asch

(74) *Attorney, Agent, or Firm*—Leydig, Voit & Mayer, Ltd.

(57) **CLAIM**

We claim the ornamental design for a portable telephone, as shown and described.

DESCRIPTION

FIG. 1 is a perspective view of a portable telephone, when the display is not rotated, according to our new design;
 FIG. 2 is a front view thereof, when the display is not rotated;
 FIG. 3 is a rear view thereof, when the display is not rotated;
 FIG. 4 is a left side view thereof, when the display is not rotated;
 FIG. 5 is a right side view thereof, when the display is not rotated;
 FIG. 6 is a top view thereof, when the display is not rotated;
 FIG. 7 is a bottom view thereof, when the display is not rotated; and,
 FIG. 8 is a front view thereof, when the display is rotated.

1 Claim, 5 Drawing Sheets

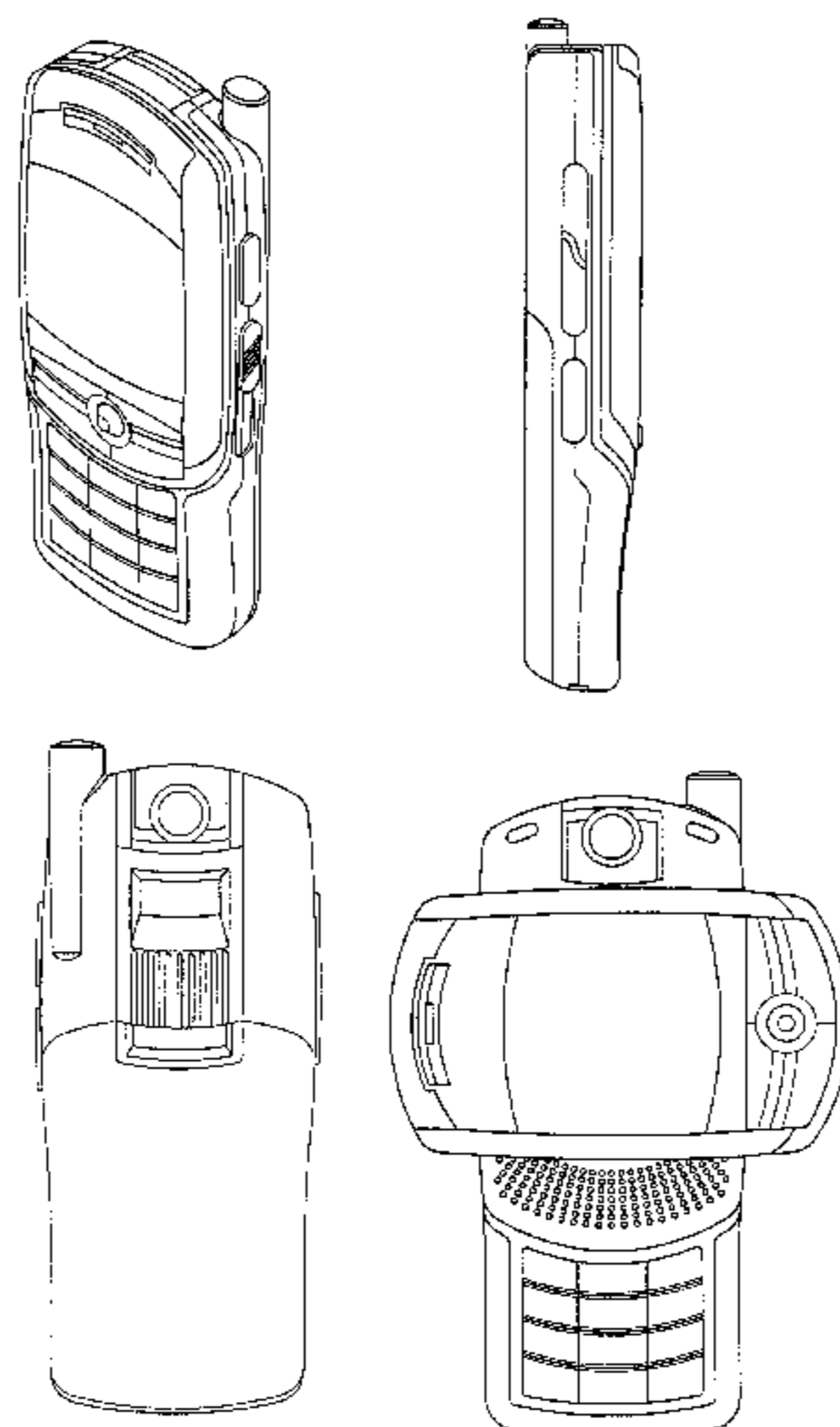

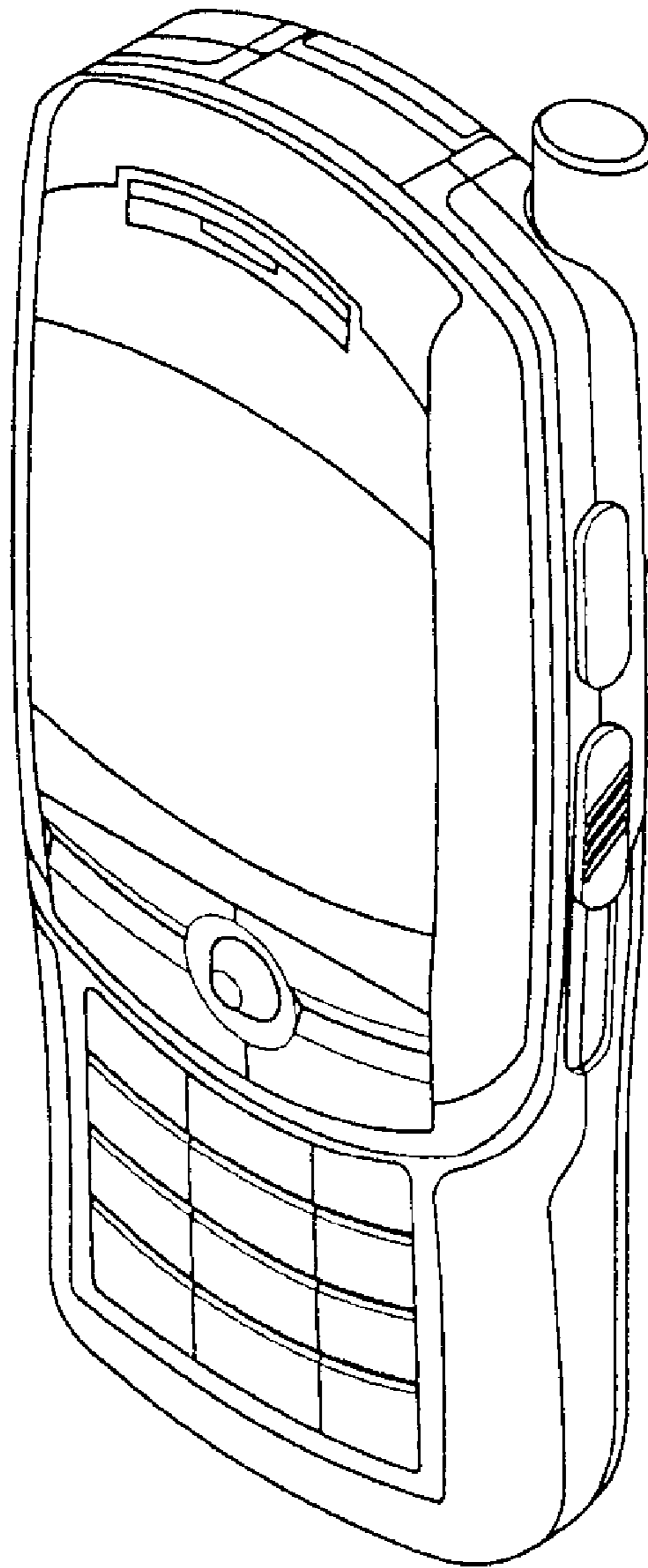

Fig. 1

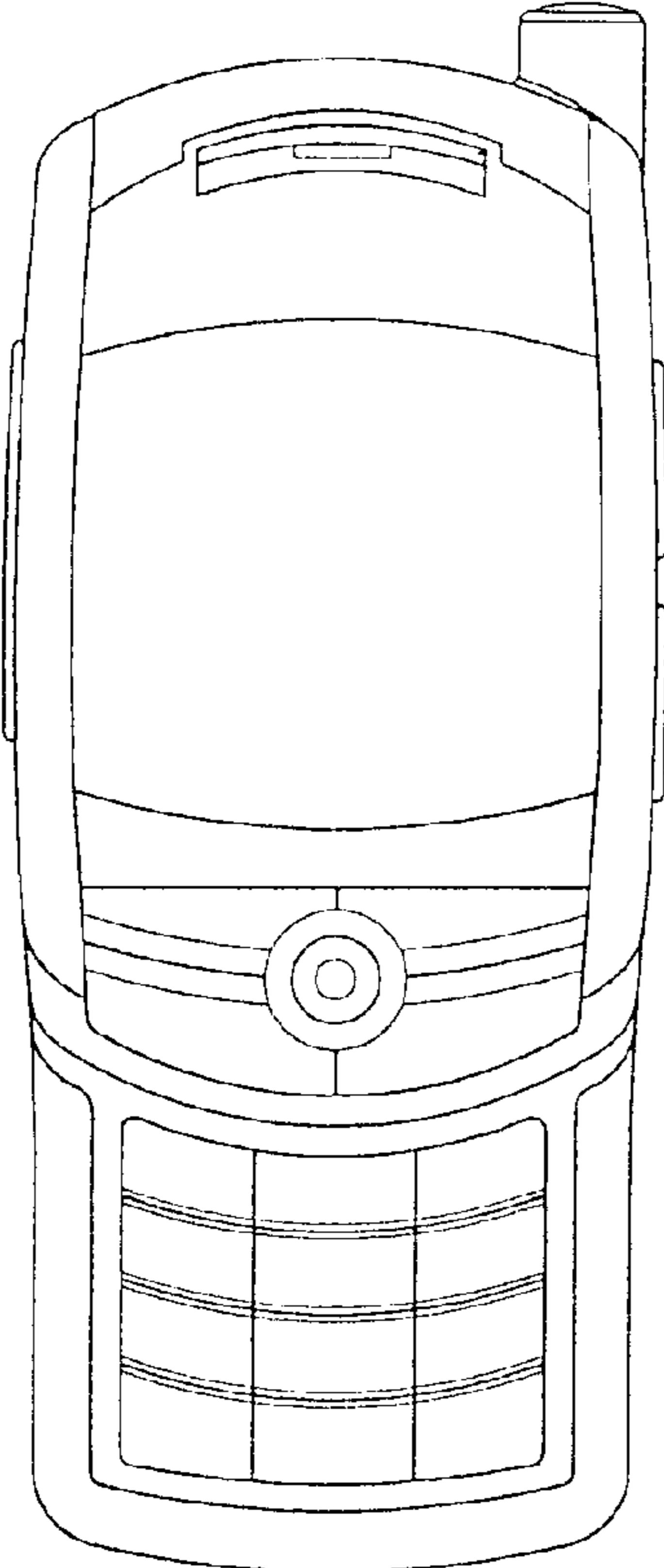

Fig. 2

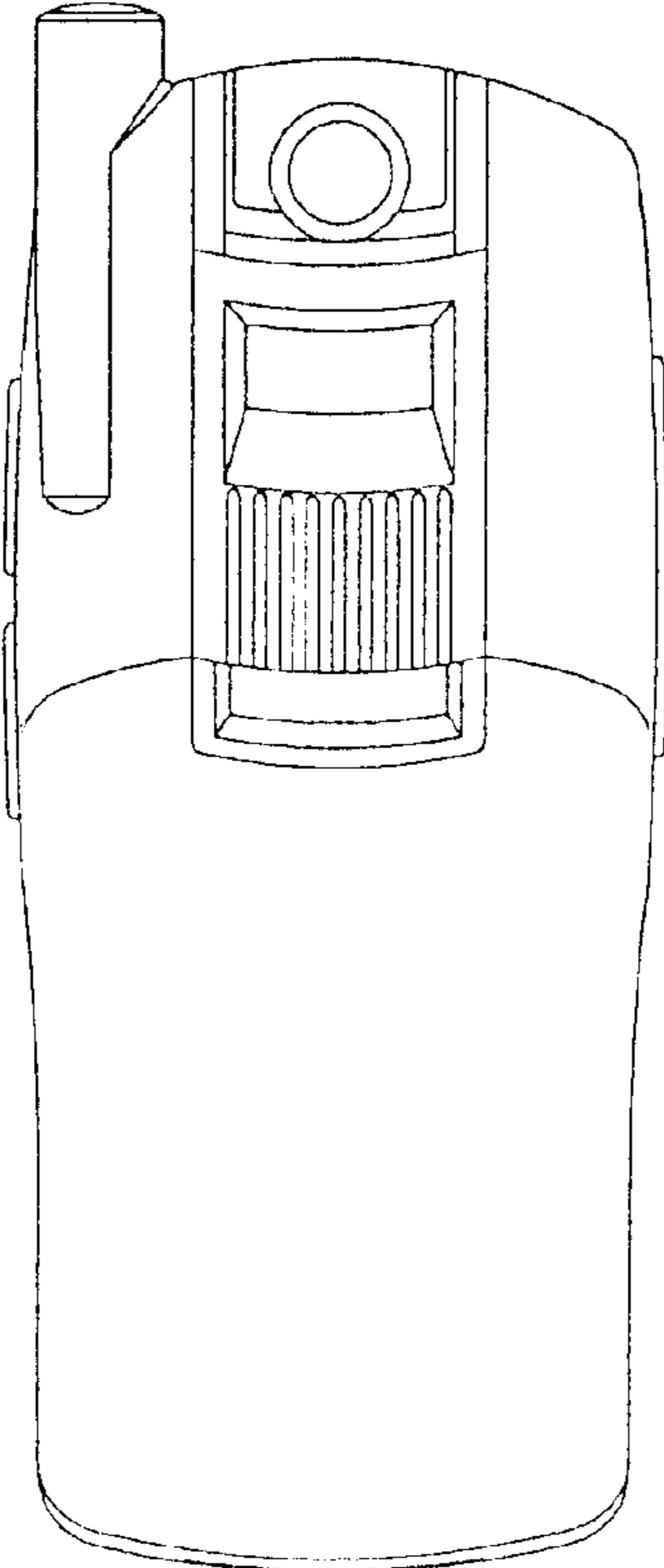

Fig. 3

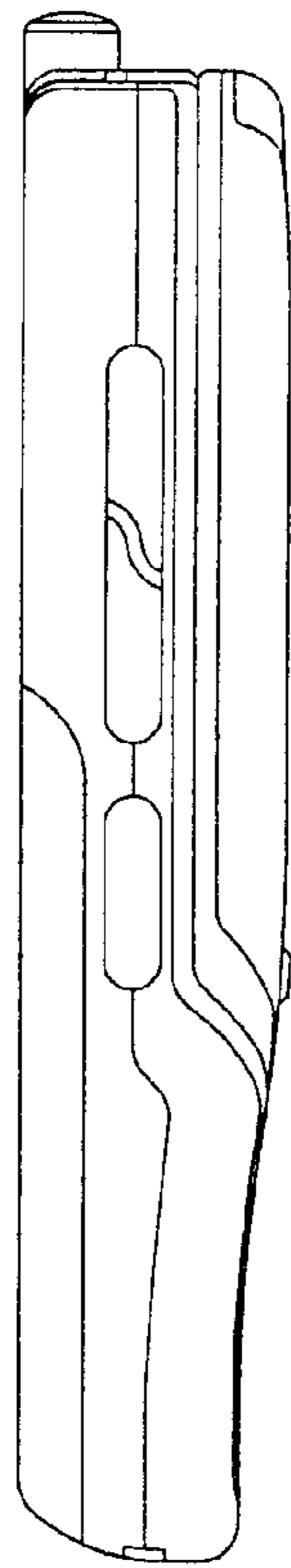

Fig. 4

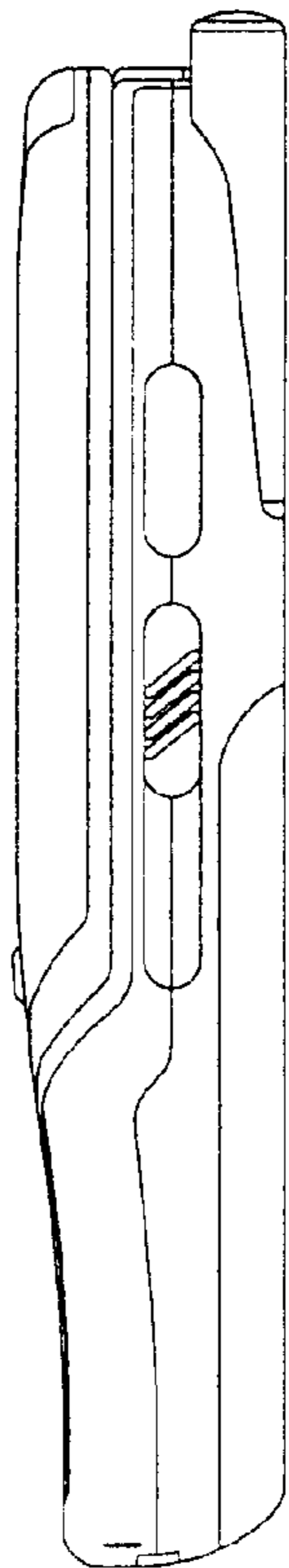

Fig. 5

Fig. 6

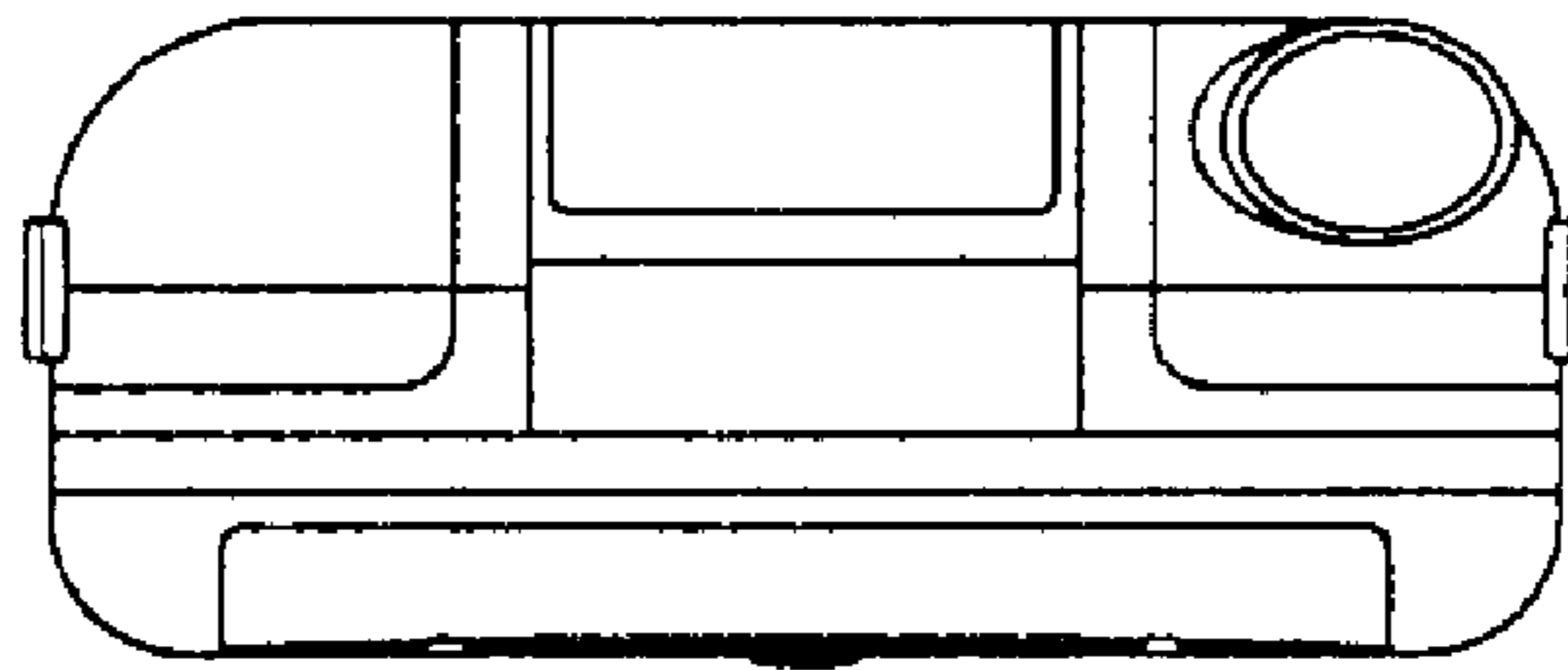

Fig. 7

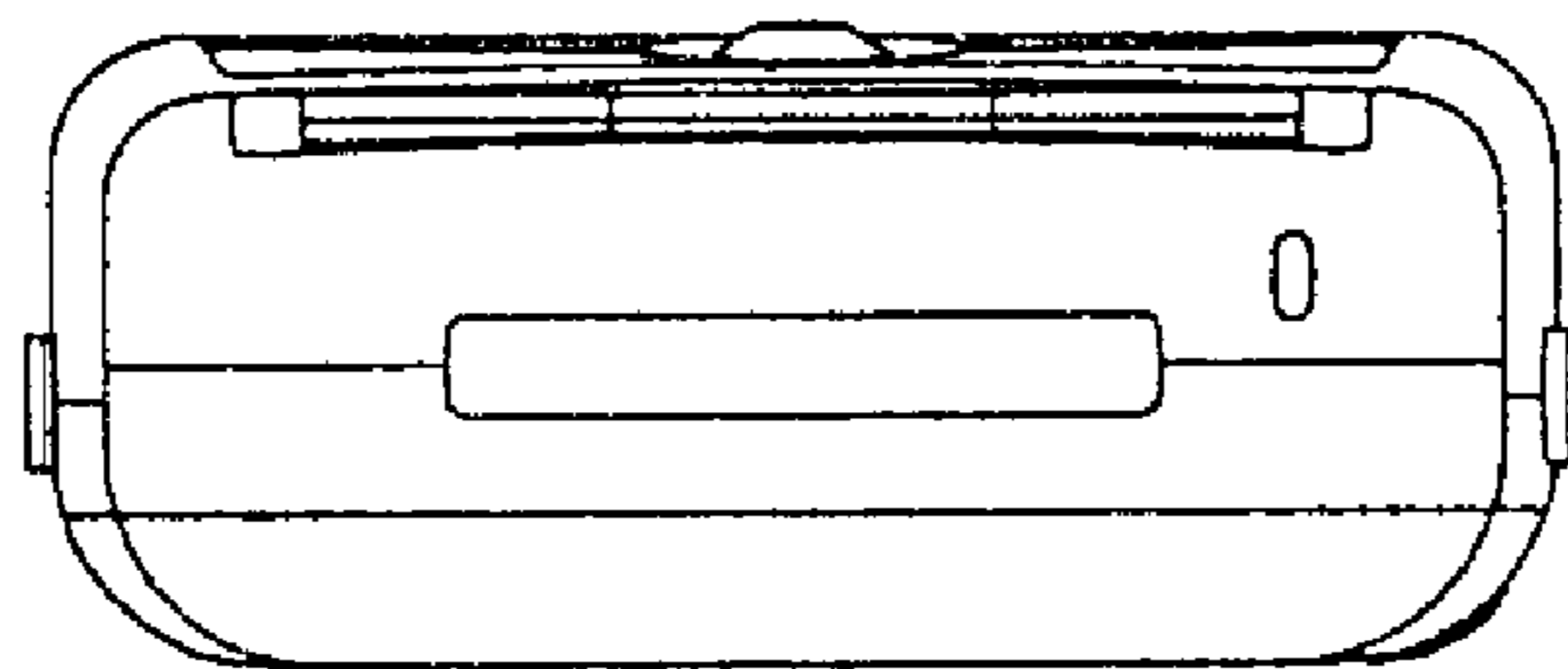

Fig. 8

