

US00D515475S

(12) **United States Design Patent**  
**Harada et al.**

(10) **Patent No.:** **US D515,475 S**  
(45) **Date of Patent:** **\*\* Feb. 21, 2006**

- (54) **BUMPER FOR AN AUTOMOBILE**
- (75) Inventors: **Yoshikazu Harada**, Aichi-ken (JP);  
**Masanari Sakae**, Aichi-ken (JP);  
**Manabu Hirokawa**, Aichi-ken (JP)
- (73) Assignee: **Toyota Jidosha Kabushiki Kaisha (JP)**
- (\*\*) Term: **14 Years**
- (21) Appl. No.: **29/219,445**
- (22) Filed: **Dec. 16, 2004**
- (51) **LOC (8) Cl.** ..... **12-16**
- (52) **U.S. Cl.** ..... **D12/169**
- (58) **Field of Classification Search** ..... D12/90-92,  
D12/86, 169, 196, 163; 296/180.1, 180.2;  
293/102, 113, 115, 117, 120  
See application file for complete search history.

- D502,675 S \* 3/2005 Ichinose et al. .... D12/169
- D504,366 S \* 4/2005 Ishibashi et al. .... D12/169
- D504,851 S \* 5/2005 Hosoda et al. .... D12/169
- D504,852 S \* 5/2005 Kubota ..... D12/169

**OTHER PUBLICATIONS**

Toyota, PREMIO 2001, Brochure of PREMIO, Dec. 2001.

\* cited by examiner

*Primary Examiner*—Melody N. Brown

(74) *Attorney, Agent, or Firm*—Saidman DesignLaw Group

(57) **CLAIM**

The ornamental design for a bumper for an automobile, as shown and described.

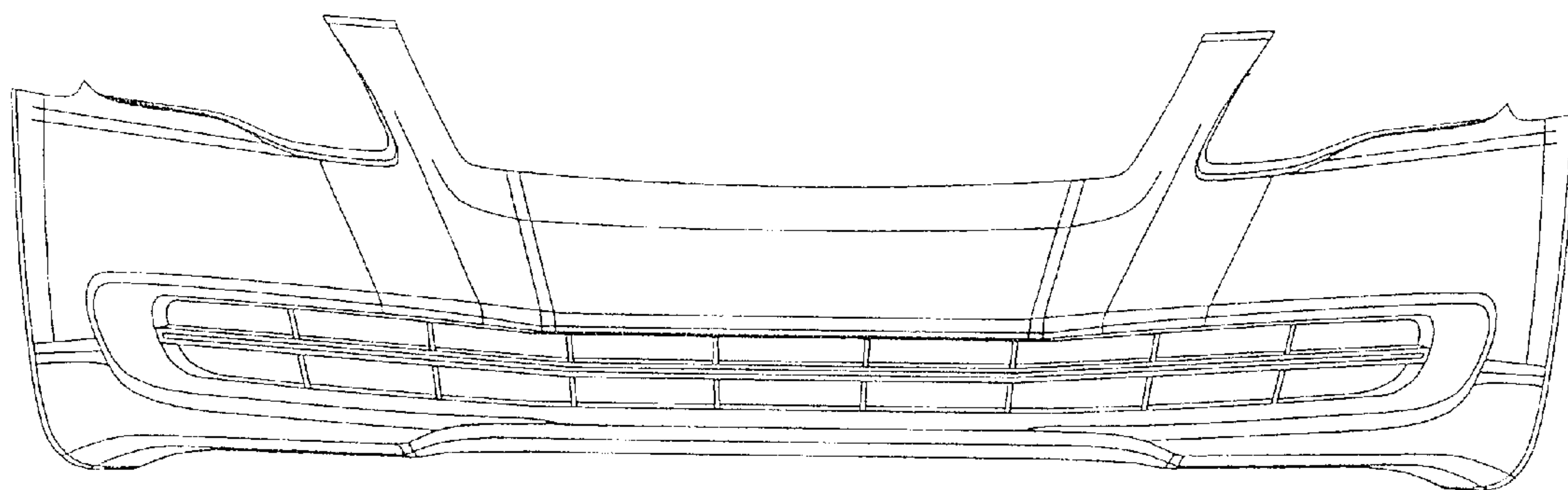
**DESCRIPTION**

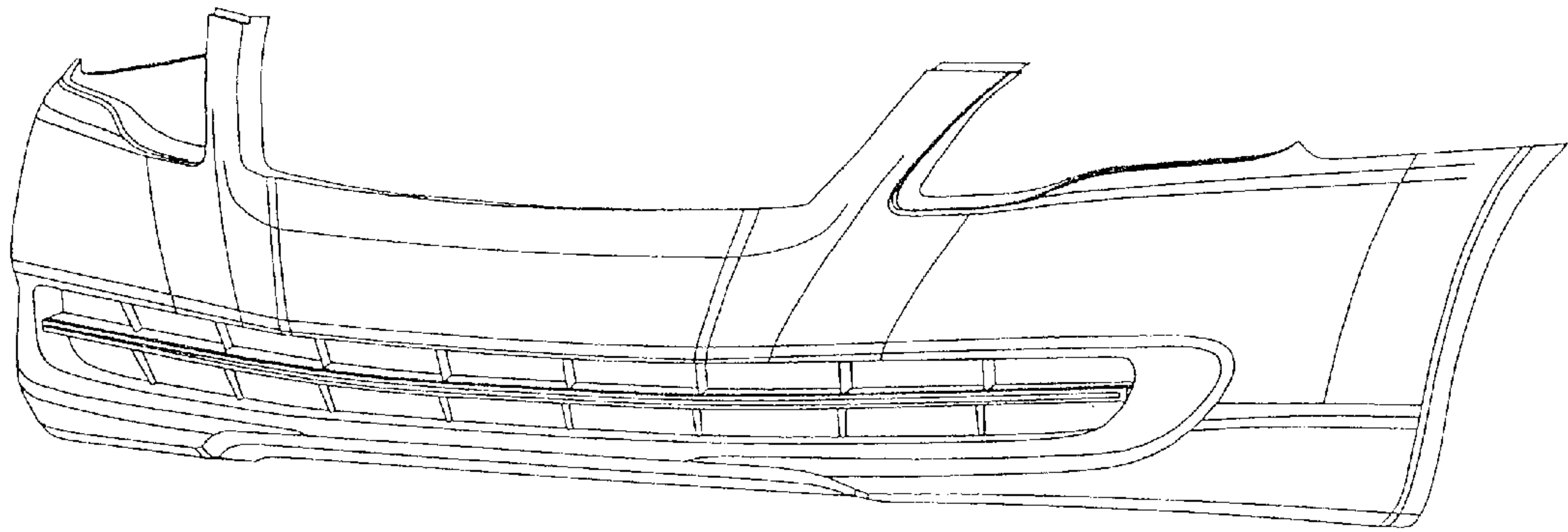
FIG. 1 is a perspective view of a bumper for an automobile showing our new design;  
 FIG. 2 is a front view thereof;  
 FIG. 3 is a rear view thereof;  
 FIG. 4 is a top view thereof;  
 FIG. 5 is a bottom view; and,  
 FIG. 6 is a right-side view thereof, the left-side view being a mirror image.

**1 Claim, 4 Drawing Sheets**

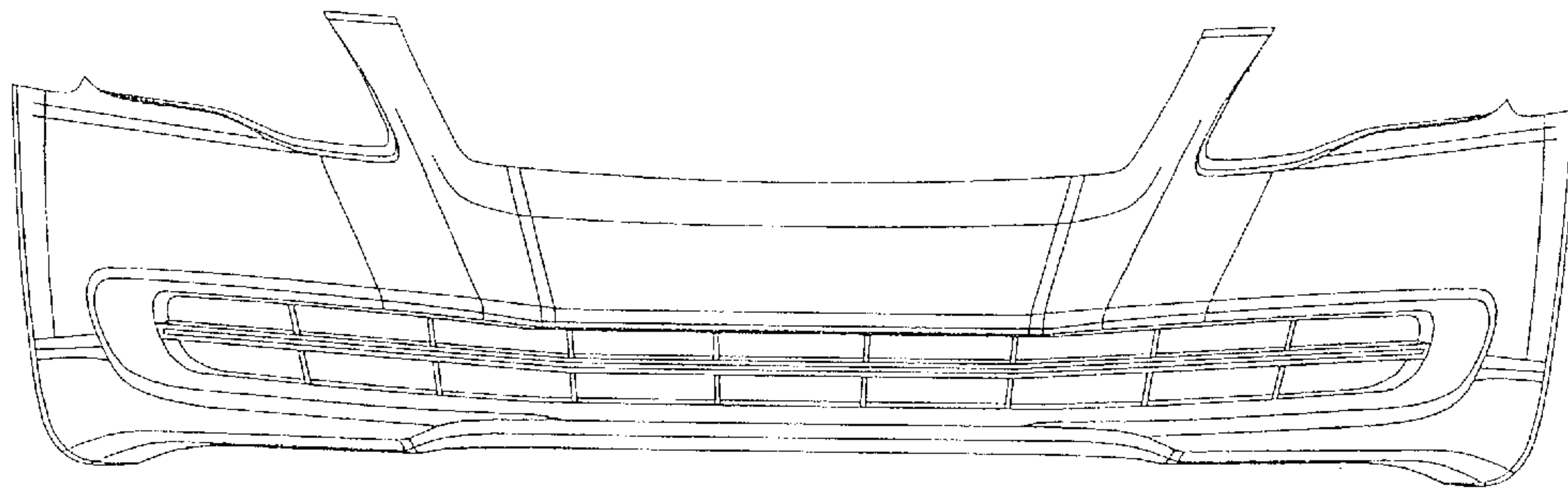
(56) **References Cited**  
**U.S. PATENT DOCUMENTS**

- D436,067 S \* 1/2001 Okano et al. .... D12/169
- D452,207 S \* 12/2001 Ishii et al. .... D12/169
- D462,640 S \* 9/2002 Sakae ..... D12/169
- D463,334 S \* 9/2002 Koman ..... D12/169
- D500,270 S \* 12/2004 Otto et al. .... D12/169
- D501,436 S \* 2/2005 Nagura et al. .... D12/169

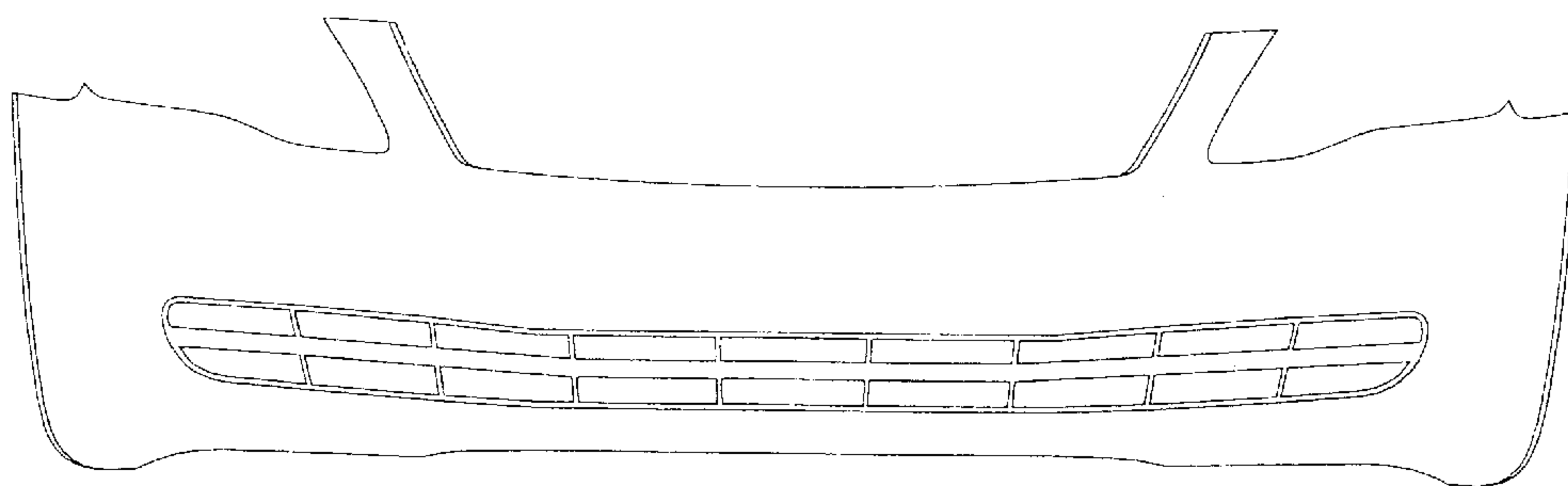




**FIG. 1**



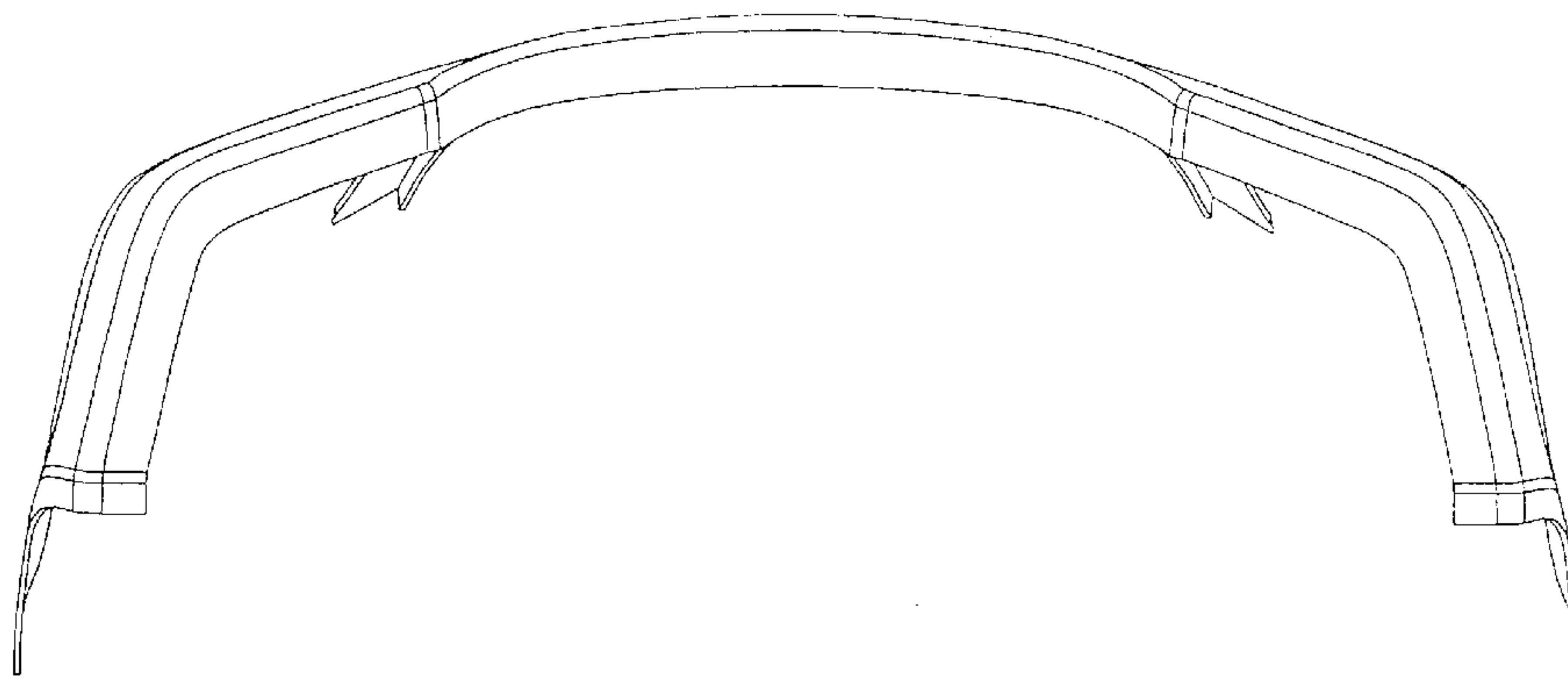
**FIG. 2**



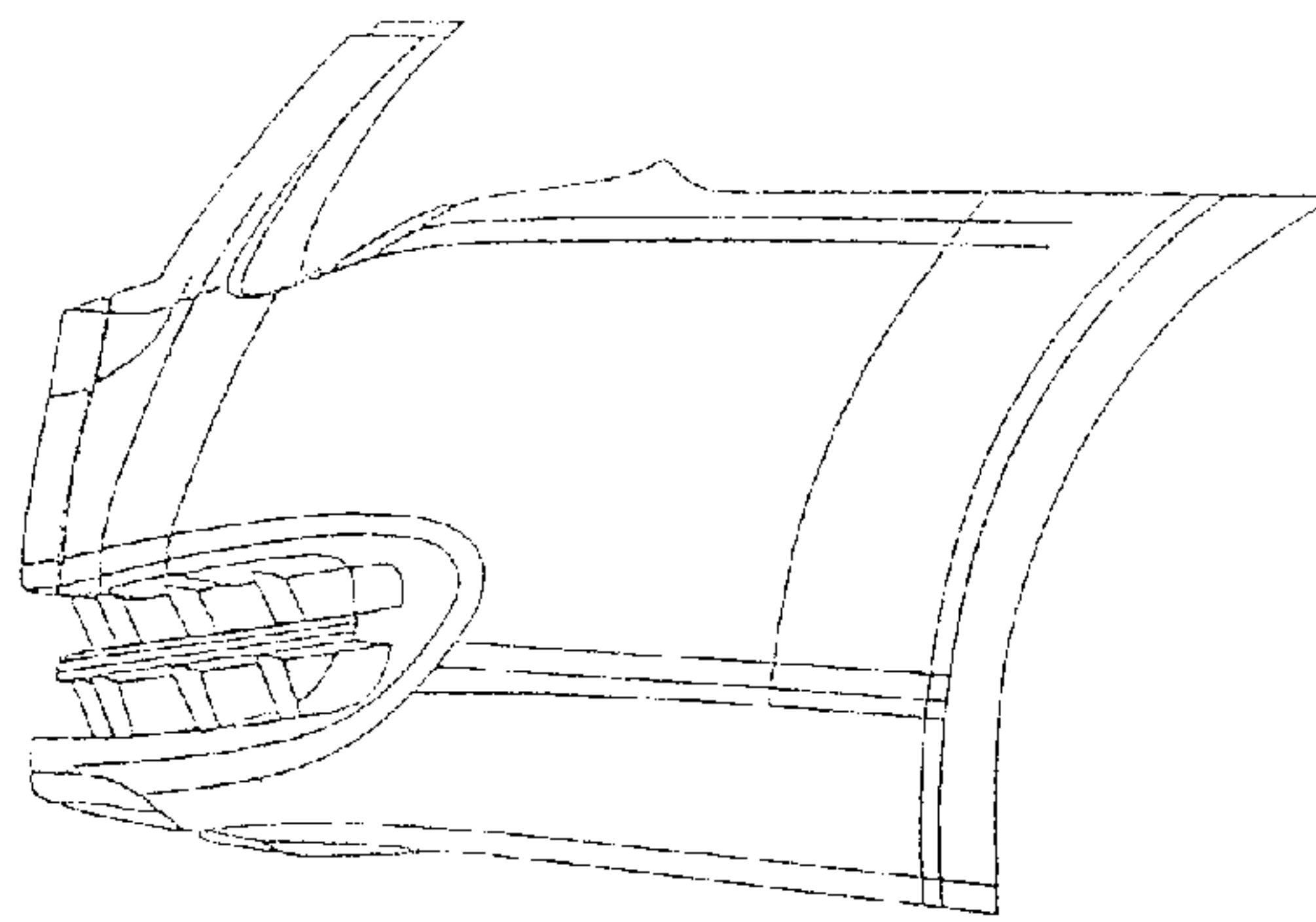
**FIG. 3**



**FIG. 4**



**FIG. 5**



**FIG. 6**