



US00D515454S

(12) **United States Design Patent**
Shah

(10) **Patent No.:** **US D515,454 S**
(45) **Date of Patent:** **** Feb. 21, 2006**

(54) **BROOCH**
(75) **Inventor:** **Mukesh Shah, Wilrijk (BE)**
(73) **Assignee:** **Munic Gems, S.A., Antwerp (BE)**
(**) **Term:** **14 Years**

D463,995 S * 10/2002 Duncan D11/109
D484,828 S * 1/2004 Sarian D11/180
D485,864 S * 1/2004 Sarian D20/11
D491,490 S * 6/2004 Real D11/165
D503,210 S * 3/2005 Sharma D22/112

* cited by examiner

Primary Examiner—Ian Simmons

Assistant Examiner—Sarah Gill

(74) *Attorney, Agent, or Firm*—Kirschstein et al.

(21) **Appl. No.:** **29/204,390**
(22) **Filed:** **Apr. 28, 2004**
(30) **Foreign Application Priority Data**

Nov. 7, 2003 (BE) 80812-00

(51) **LOC (8) Cl.** **11-01**
(52) **U.S. Cl.** **D11/61**
(58) **Field of Classification Search** D11/11–13,
D11/20, 44, 61, 80–81, 165, 95, 167, 180,
D11/109, 125; 63/13, 18–19, 23; D3/208;
D22/112; 40/584; D99/34; D9/667
See application file for complete search history.

(57) **CLAIM**

The ornamental design for a brooch, as shown and described.

DESCRIPTION

FIG. 1 is a front, perspective view of a brooch according to my new design;
FIG. 2 is a rear, perspective view thereof;
FIG. 3 is a side, perspective view thereof;
FIG. 4 is an opposite side, perspective view thereof;
FIG. 5 is a top plan view thereof; and,
FIG. 6 is a bottom plan view thereof.
The dashed lines are for environmental purposes only and form no part of this invention.

(56) **References Cited**

U.S. PATENT DOCUMENTS

D273,576 S * 4/1984 Millan-Perichon D11/167
D448,912 S * 10/2001 Galbraith, Jr. D99/34
D456,244 S * 4/2002 Davis D9/667

1 Claim, 3 Drawing Sheets

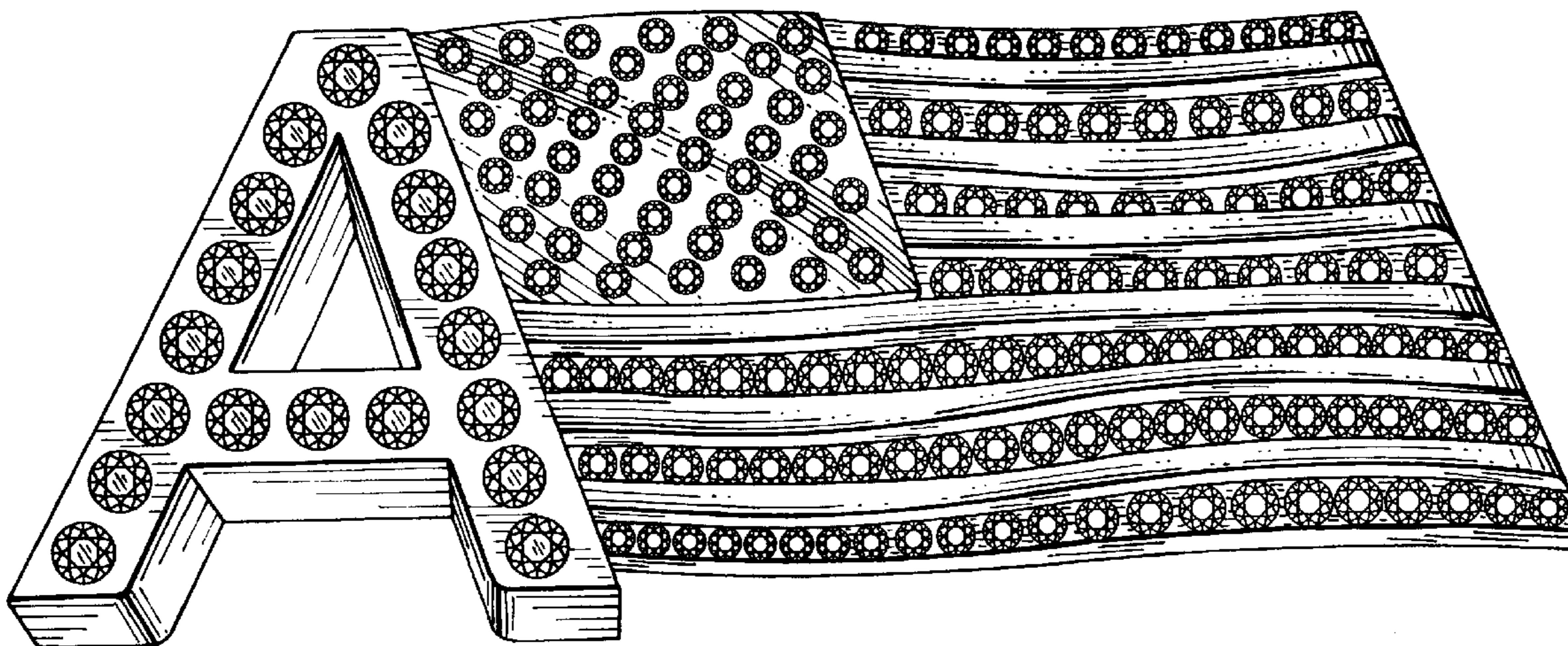

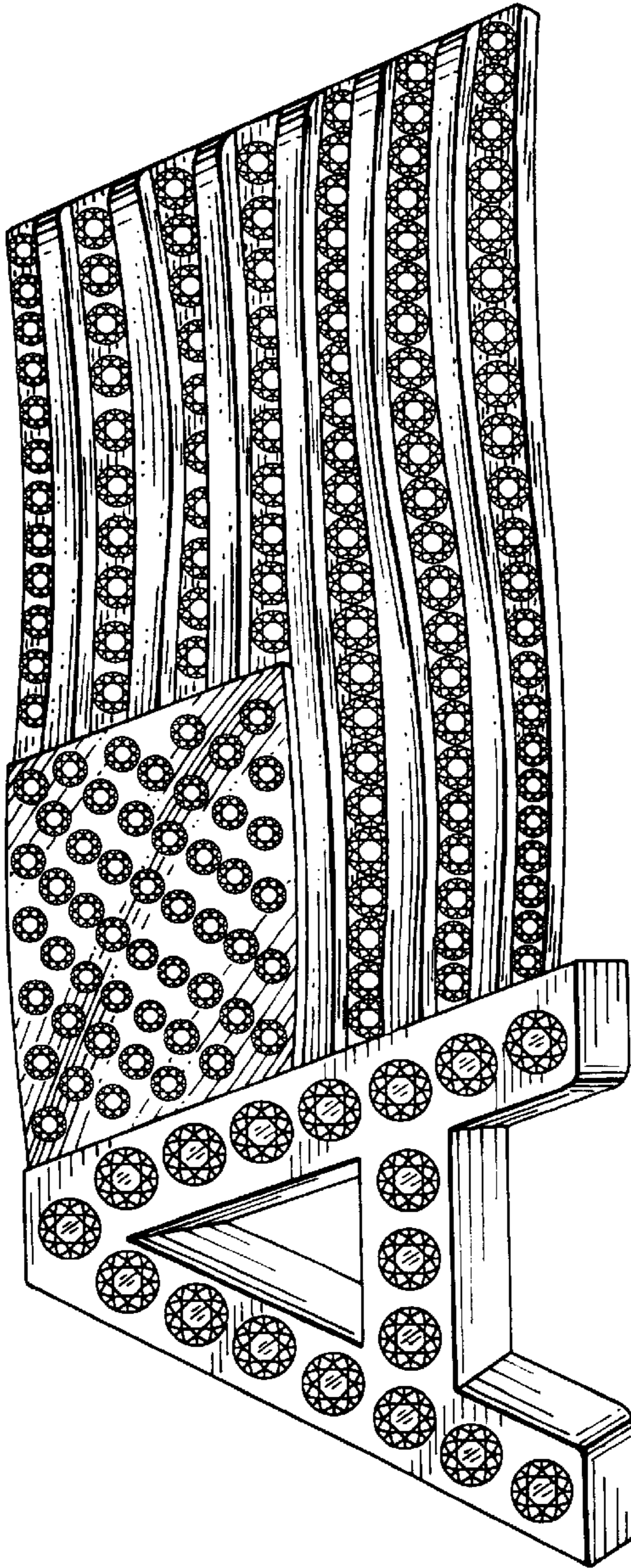

FIG. 1

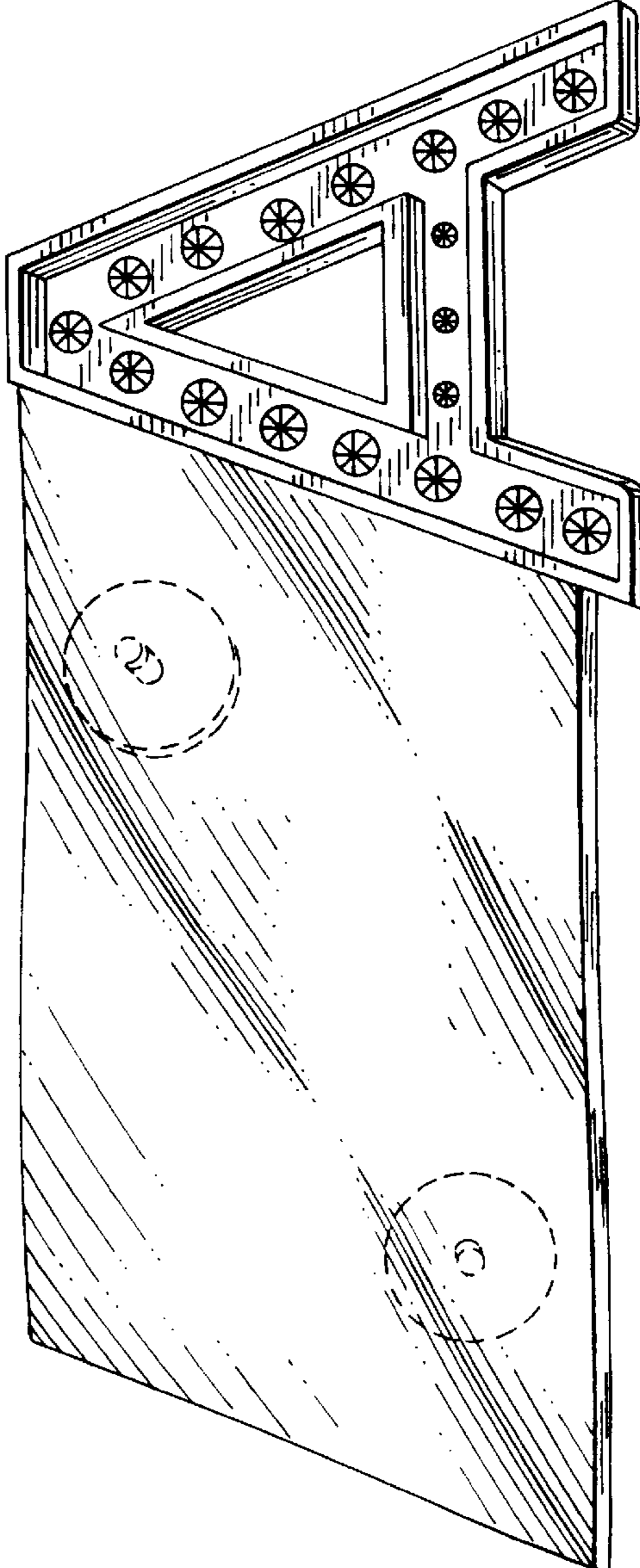

FIG. 2

FIG. 3

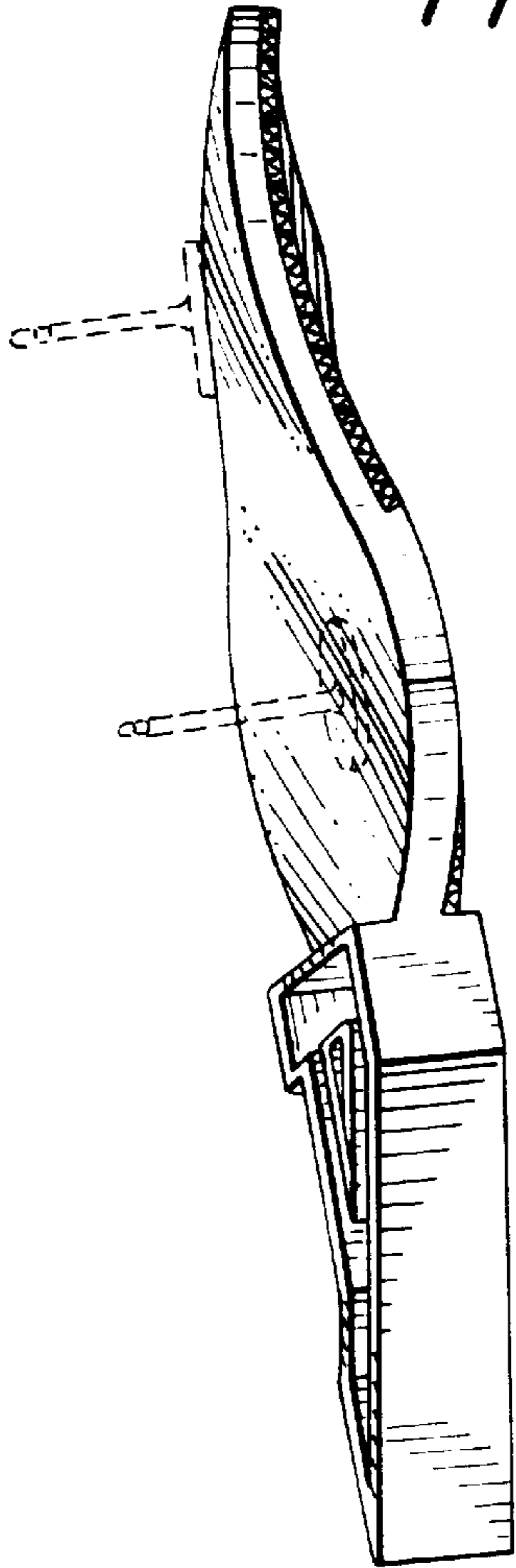
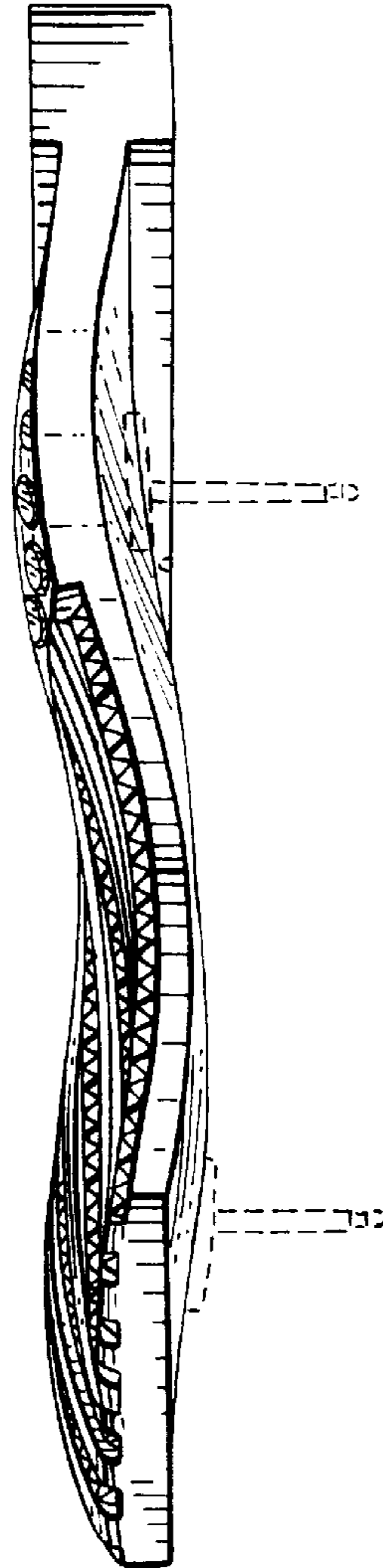

FIG. 4



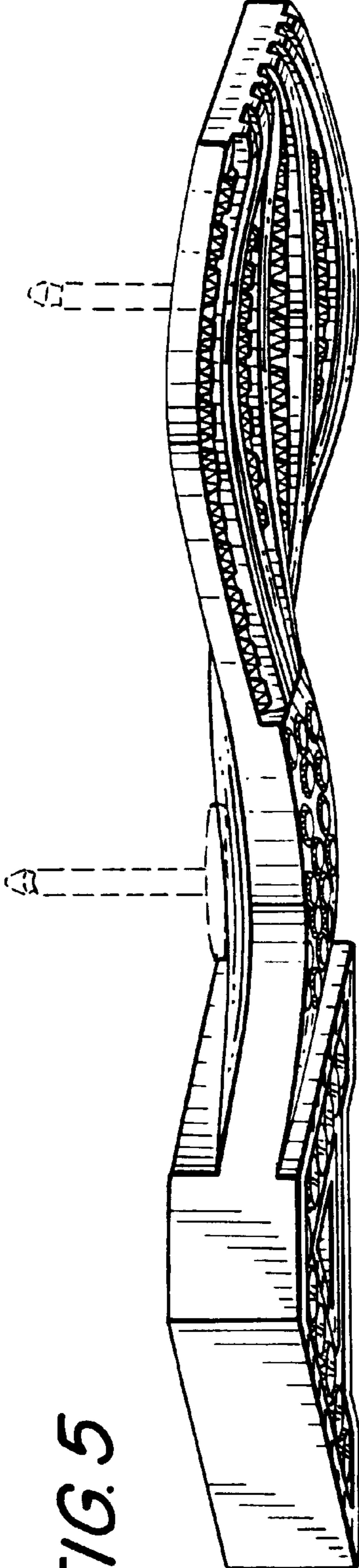

FIG. 5

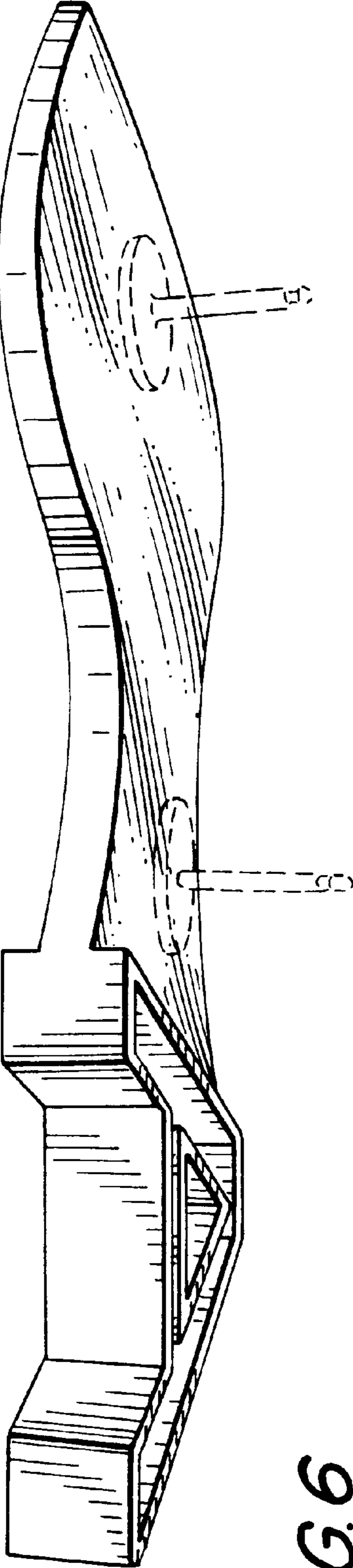

FIG. 6