



US00D515423S

(12) **United States Design Patent**
Chu

(10) **Patent No.:** **US D515,423 S**

(45) **Date of Patent:** **** Feb. 21, 2006**

(54) **NOTEBOOK'S CUSHIONING PACKAGING STRUCTURE**

D408,737 S * 4/1999 Warren, Jr. D9/456
D470,053 S * 2/2003 Gratz D9/456

(76) **Inventor:** **Cheng-Kang Chu**, 4F -8, No. 123, Sec. 3, Taijunggang Rd., Shituen Chiu, Taichung City 407 (TW)

* cited by examiner

Primary Examiner—Robert M. Spear
Assistant Examiner—Susan Bennett Hattan

(**) **Term:** **14 Years**

(57) **CLAIM**

(21) **Appl. No.:** **29/204,780**

The ornamental design for a notebook's cushioning packaging structure, as shown and described.

(22) **Filed:** **May 5, 2004**

DESCRIPTION

(51) **LOC (8) Cl.** **09-07**

(52) **U.S. Cl.** **D9/456**

(58) **Field of Classification Search** D9/755,
D9/732, 499, 456, 455, 453, 452, 432, 431,
D9/429, 428, 425, 424, 418, 414; D7/672,
D7/641, 629, 610, 608, 602, 601, 587, 392.1;
D3/272, 269, 319, 315, 310, 304; 426/114,
426/113; 229/906, 904, 903, 902, 407, 406;
220/DIG. 12, 675, 672, 670, 669, 574, 556,
220/4.26, 306, 557, 508, 203; 219/732

FIG. 1 is a perspective view of a notebook's cushioning packaging structure showing our new design; FIG. 2 is a left side elevational view thereof; FIG. 3 is a right side elevational view thereof; FIG. 4 is a front elevational view thereof; FIG. 5 is a rear elevational view thereof; FIG. 6 is a top plan view thereof; FIG. 7 is a bottom plan view thereof; and, FIG. 8 is a perspective view of a notebook's cushioning packaging structure in use with a notebook computer.

See application file for complete search history.

The broken lines in the drawings are for illustrative purposes only and form no part of the claimed design.

(56) **References Cited**

U.S. PATENT DOCUMENTS

D403,961 S * 1/1999 Warren D9/456

1 Claim, 8 Drawing Sheets

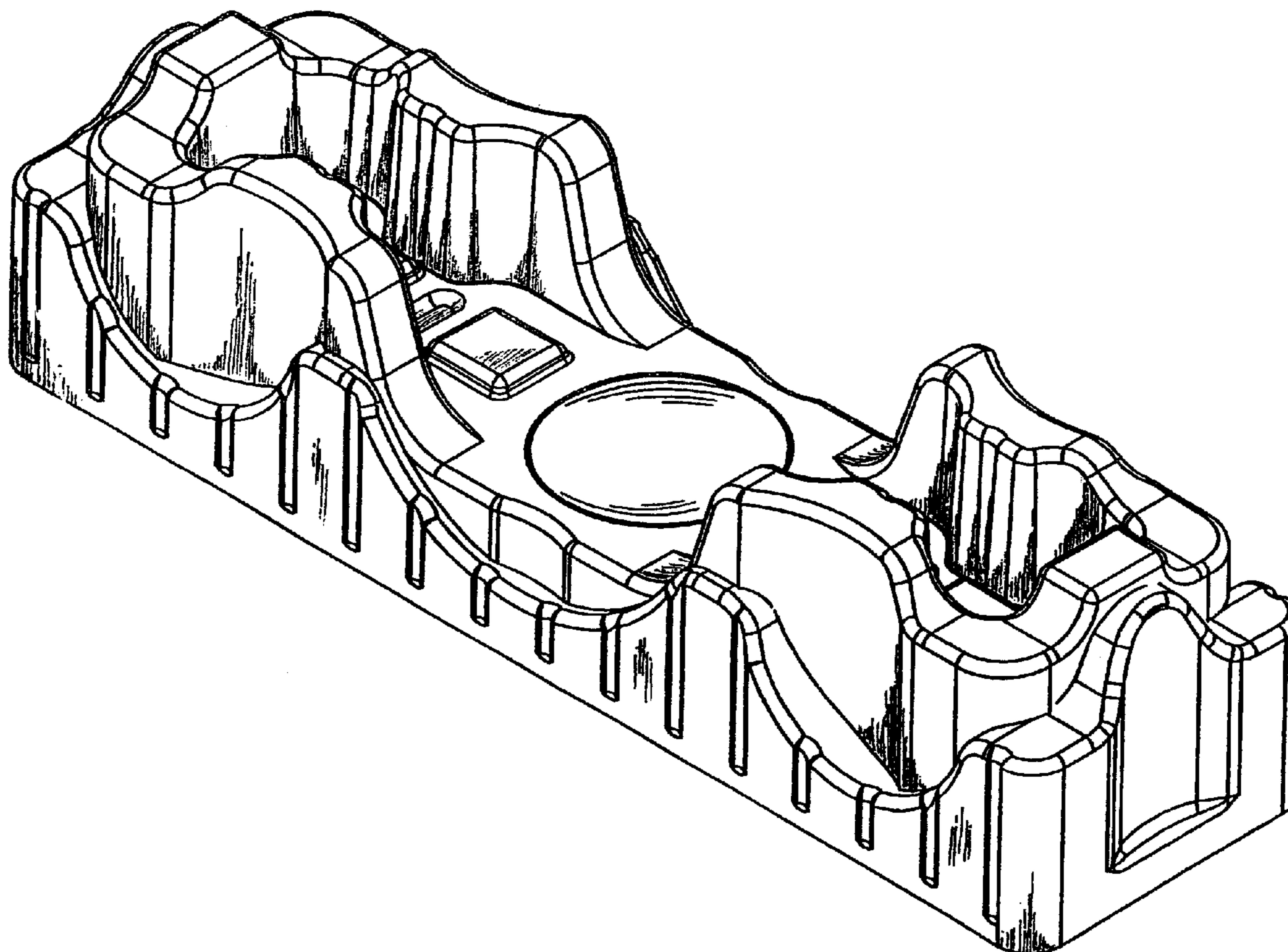

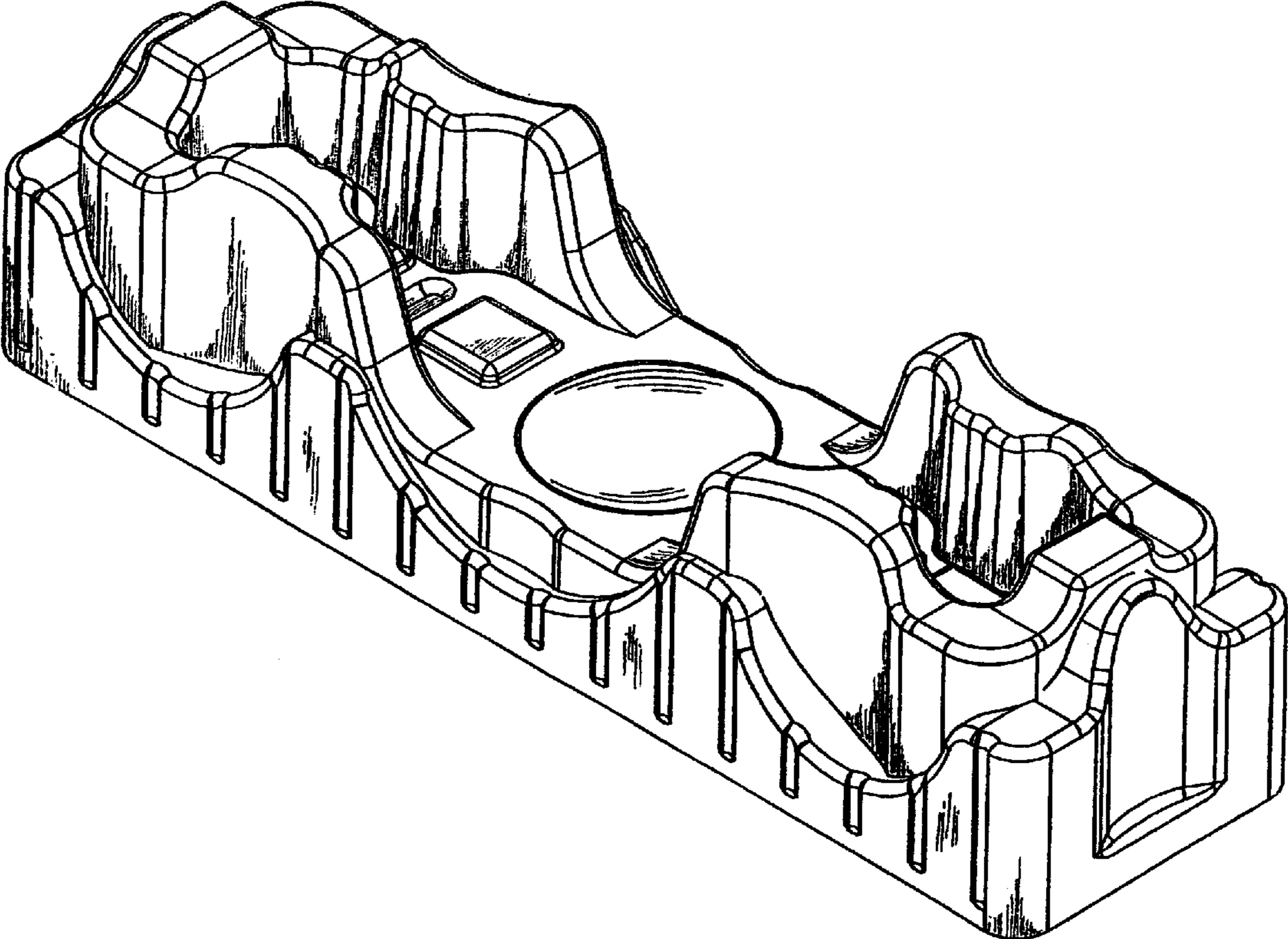

Fig.1

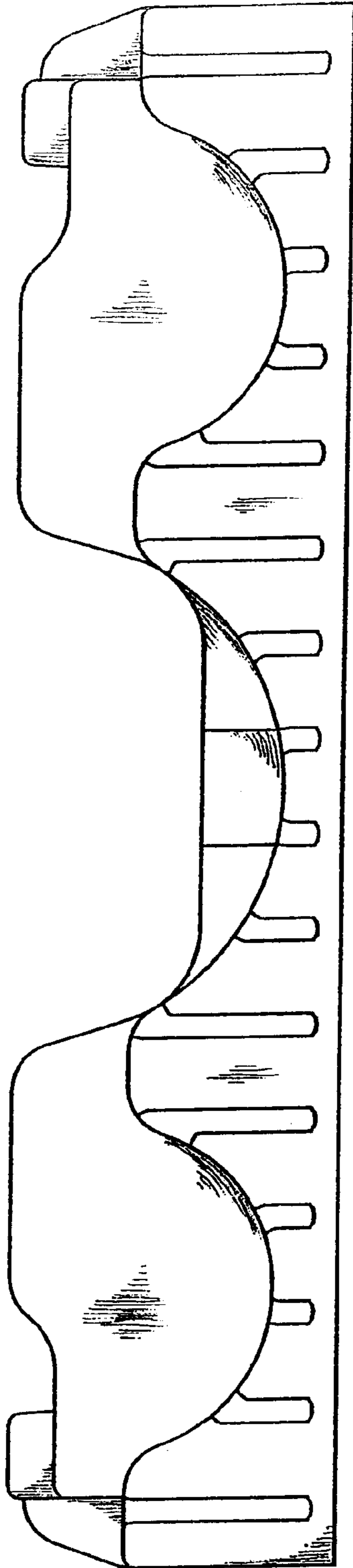

Fig.2

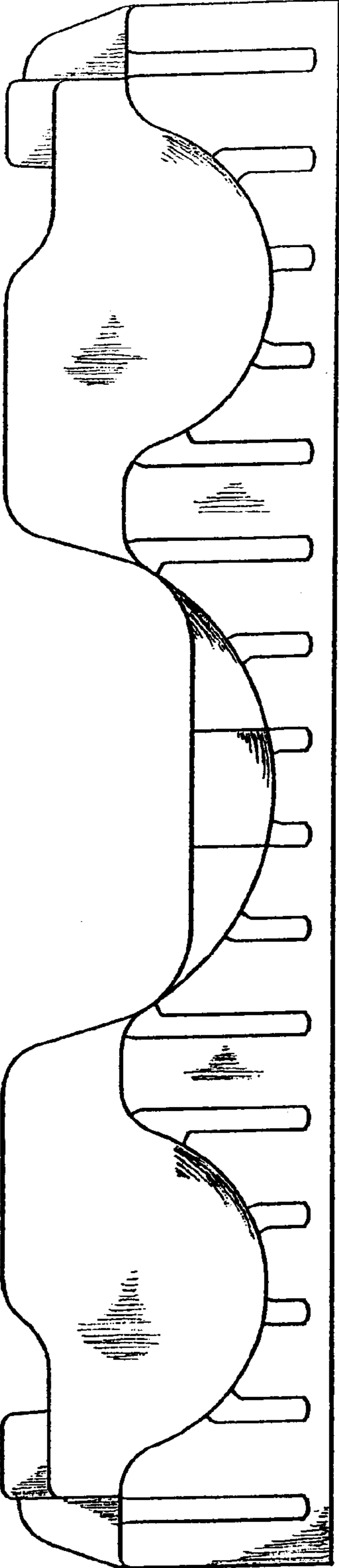

Fig.3

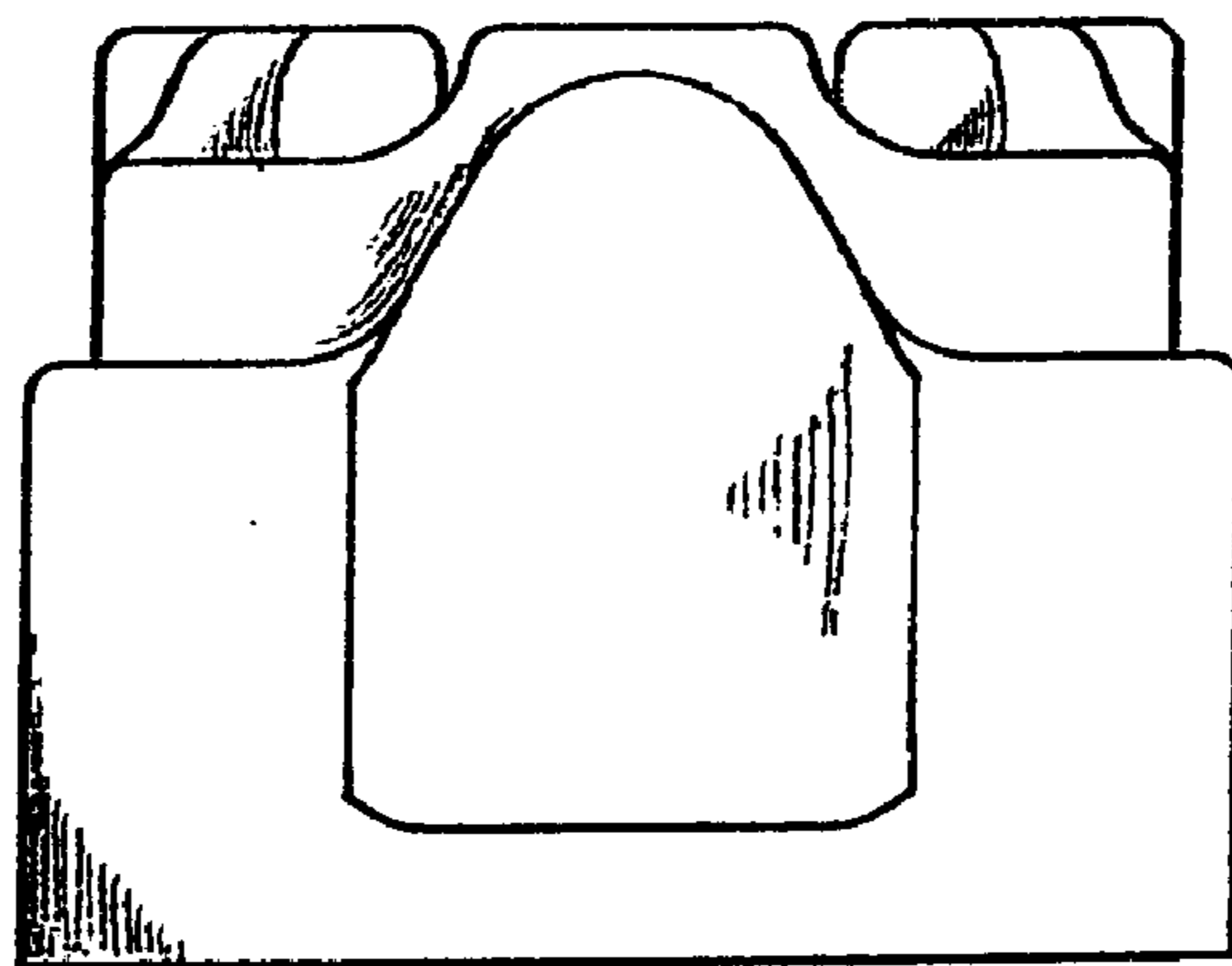

Fig.4

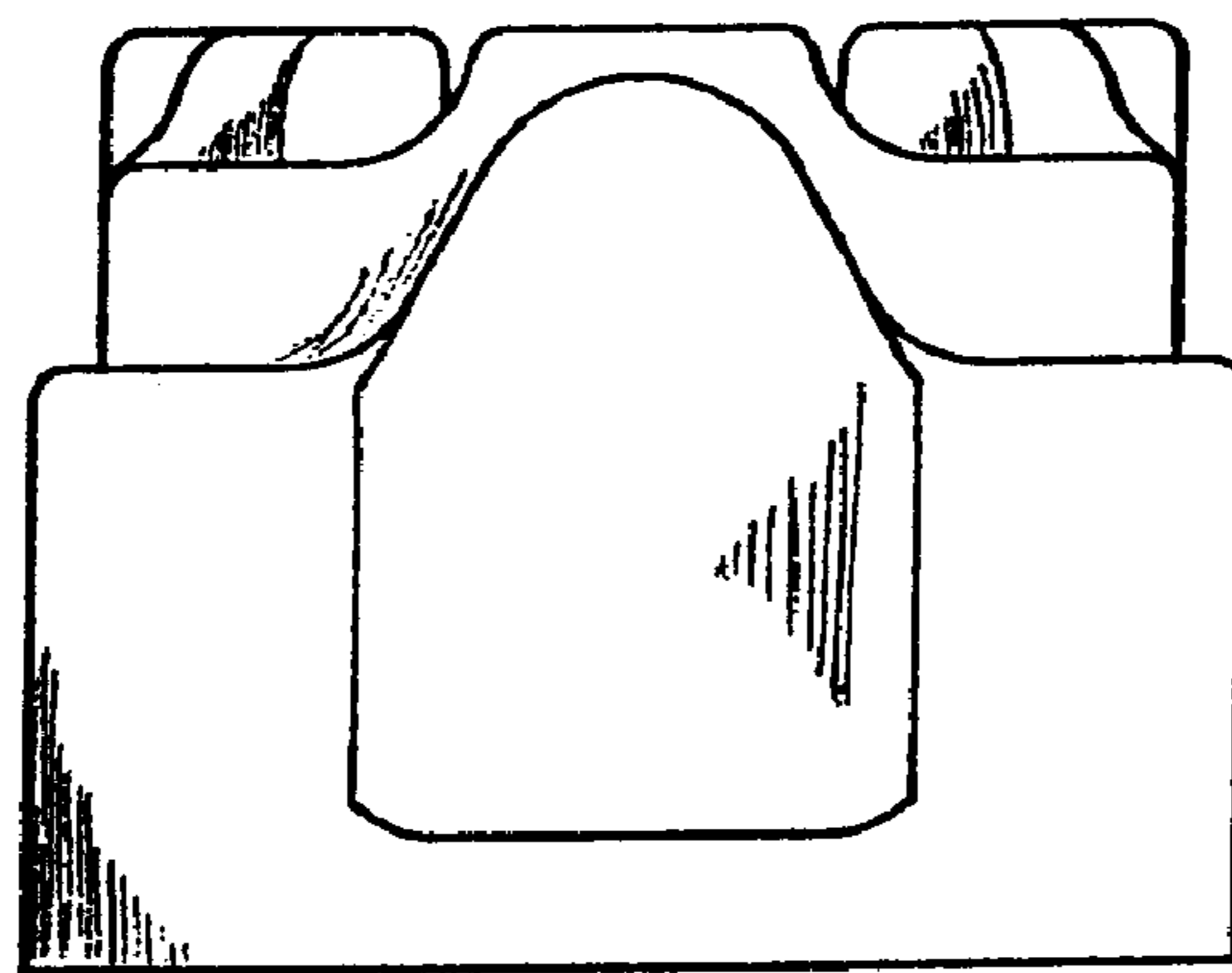

Fig.5

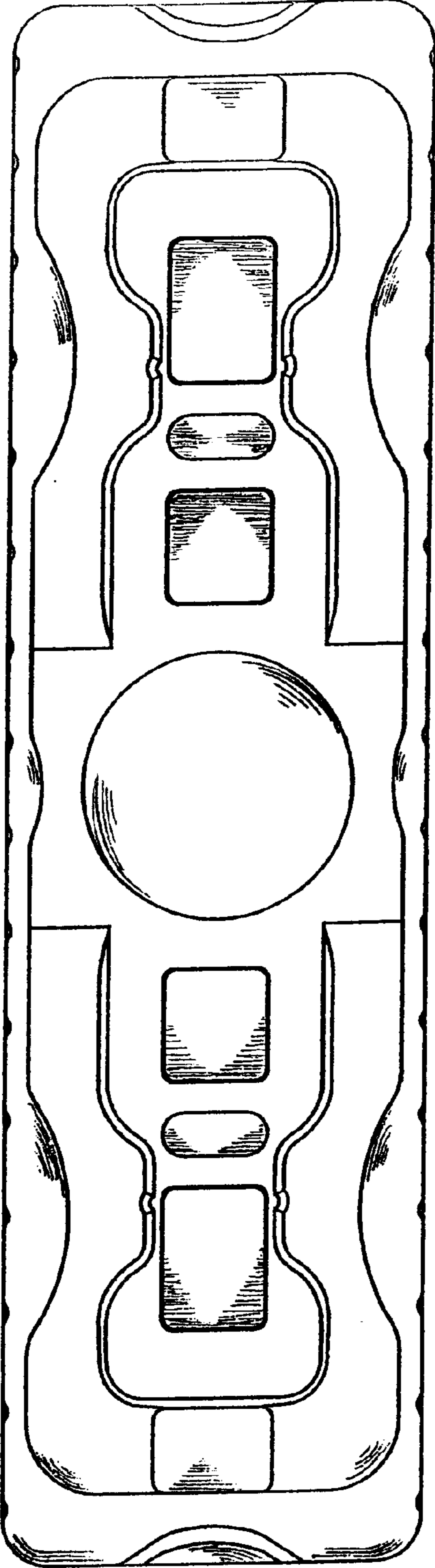

Fig.6

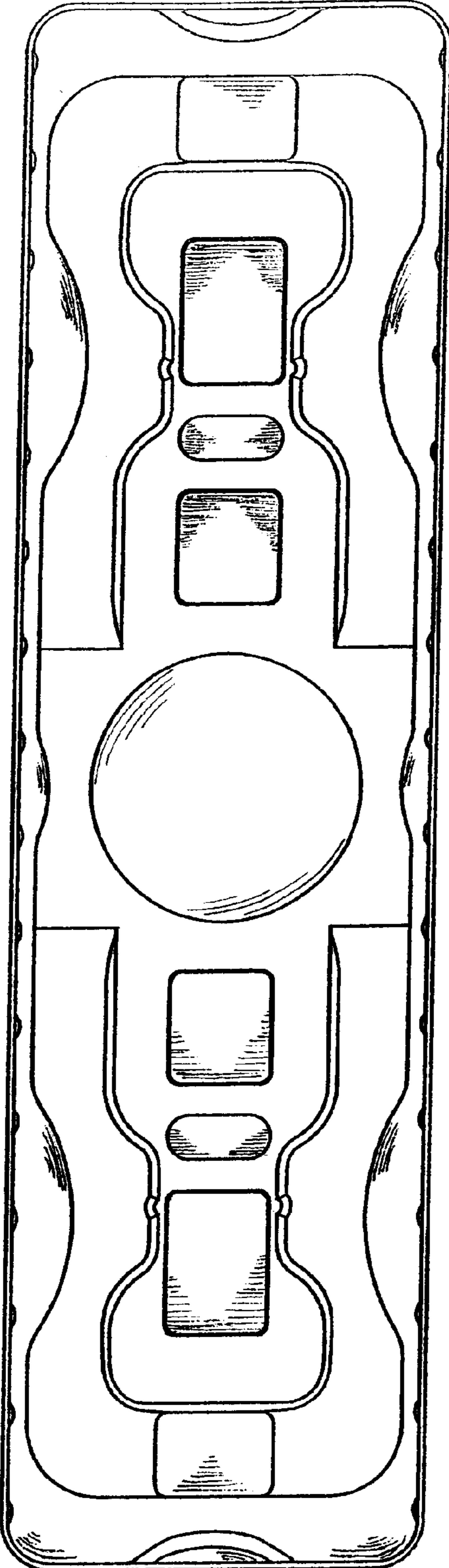

Fig.7

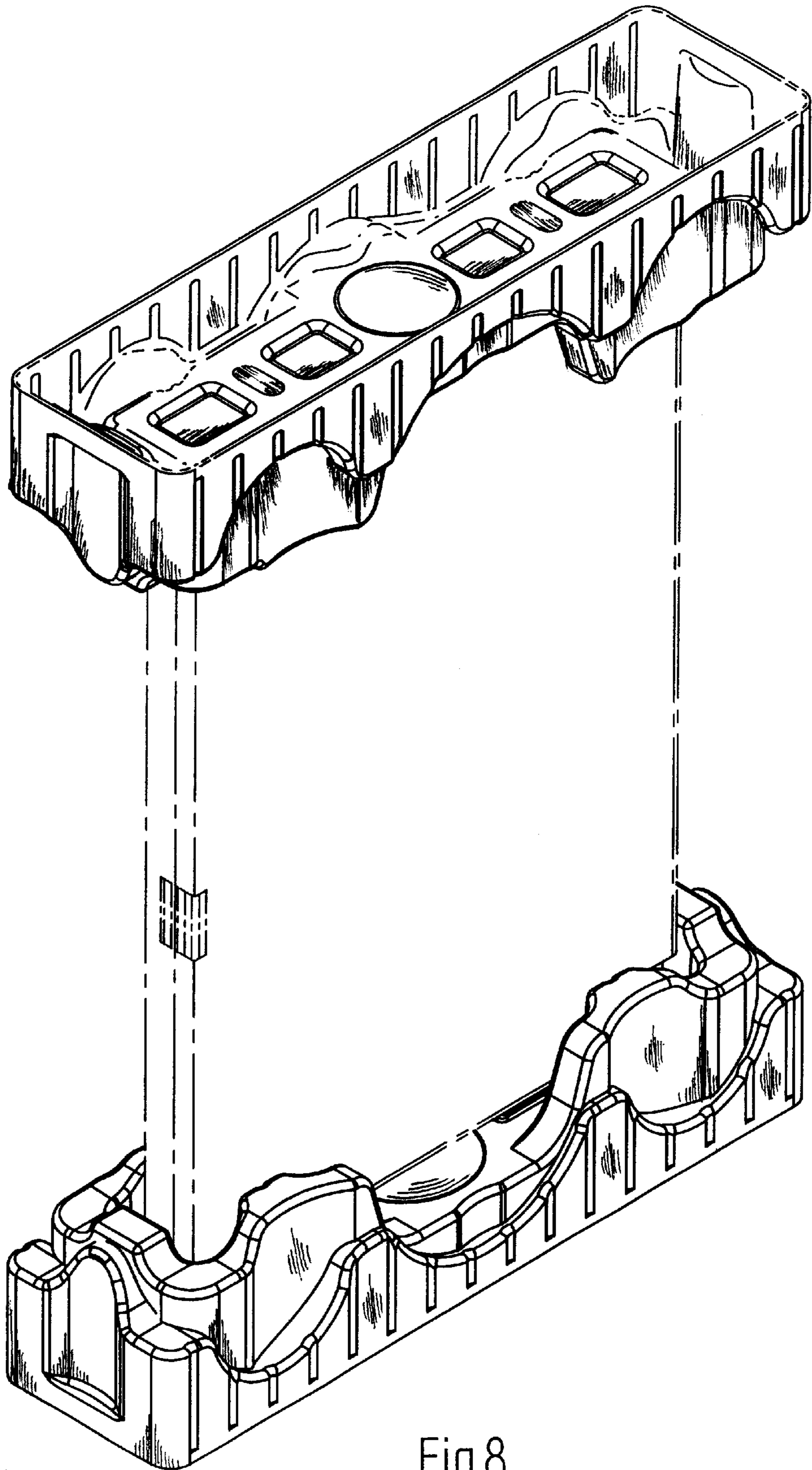

Fig.8