



US00D515362S

(12) **United States Design Patent**  
**Chan**

(10) **Patent No.: US D515,362 S**

(45) **Date of Patent: \*\* Feb. 21, 2006**

(54) **CONTAINER**

(75) Inventor: **Chik Sum Chan**, New Territories (HK)

(73) Assignee: **Kado Industrial Co., Ltd.**, Hong Kong (HK)

(\*\*) Term: **14 Years**

(21) Appl. No.: **29/215,838**

(22) Filed: **Oct. 25, 2004**

(30) **Foreign Application Priority Data**

Apr. 26, 2004 (HK) ..... 0410876

(51) **LOC (8) Cl. .... 07-01**

(52) **U.S. Cl. .... D7/607; D7/709; D3/289**

(58) **Field of Classification Search** ..... D7/605-608,  
D7/709, 710; D3/273, 276, 283-287, 289;  
62/457.1-457.9; 150/112, 117; 190/108-110,  
190/112; 220/592.23-592.25, 592.2, 495.03,  
220/915.1, 915.2; 383/6, 42, 97, 110, 111

See application file for complete search history.

(56) **References Cited**

**U.S. PATENT DOCUMENTS**

4,050,264	A	*	9/1977	Tanaka	.....	62/457.2
4,537,313	A	*	8/1985	Workman	.....	383/110
4,805,776	A	*	2/1989	Namgyal et al.	.....	383/97
4,984,906	A	*	1/1991	Little	.....	383/97
5,400,610	A	*	3/1995	Macedo	.....	383/110
5,403,095	A	*	4/1995	Melk	.....	383/110
5,421,172	A	*	6/1995	Jones	.....	62/457.5
D382,771	S	*	8/1997	Mogil	.....	D7/607
D403,926	S	*	1/1999	Sutton	.....	D7/607
6,068,402	A	*	5/2000	Freese et al.	.....	383/110

\* cited by examiner

*Primary Examiner*—Terry A. Wallace

(74) *Attorney, Agent, or Firm*—Seed IP Law Group PLLC

(57) **CLAIM**

The ornamental design for a container, as shown and described.

**DESCRIPTION**

FIG. 1 is a perspective view of a container in an expanded configuration with the cover closed, showing my new design.

FIG. 2 is a plan view thereof.

FIG. 3 is a front elevation view thereof.

FIG. 4 is a bottom view thereof.

FIG. 5 is a rear elevation view thereof.

FIG. 6 is a right side view thereof.

FIG. 7 is a left side view thereof.

FIG. 8 is a perspective view of the container in an expanded configuration with the cover opened.

FIG. 9 is a plan view thereof.

FIG. 10 is a rear elevation view thereof.

FIG. 11 is a front elevation view thereof.

FIG. 12 is a bottom view thereof.

FIG. 13 is a right side view thereof.

FIG. 14 is a left side view thereof.

FIG. 15 is a perspective view of the container in a collapsed configuration.

FIG. 16 is a rear elevation view thereof.

FIG. 17 is a right side view thereof.

FIG. 18 is a left side view thereof.

FIG. 19 is a plan view thereof.

FIG. 20 is a front elevation view thereof; and,

FIG. 21 is a bottom view thereof.

**1 Claim, 10 Drawing Sheets**

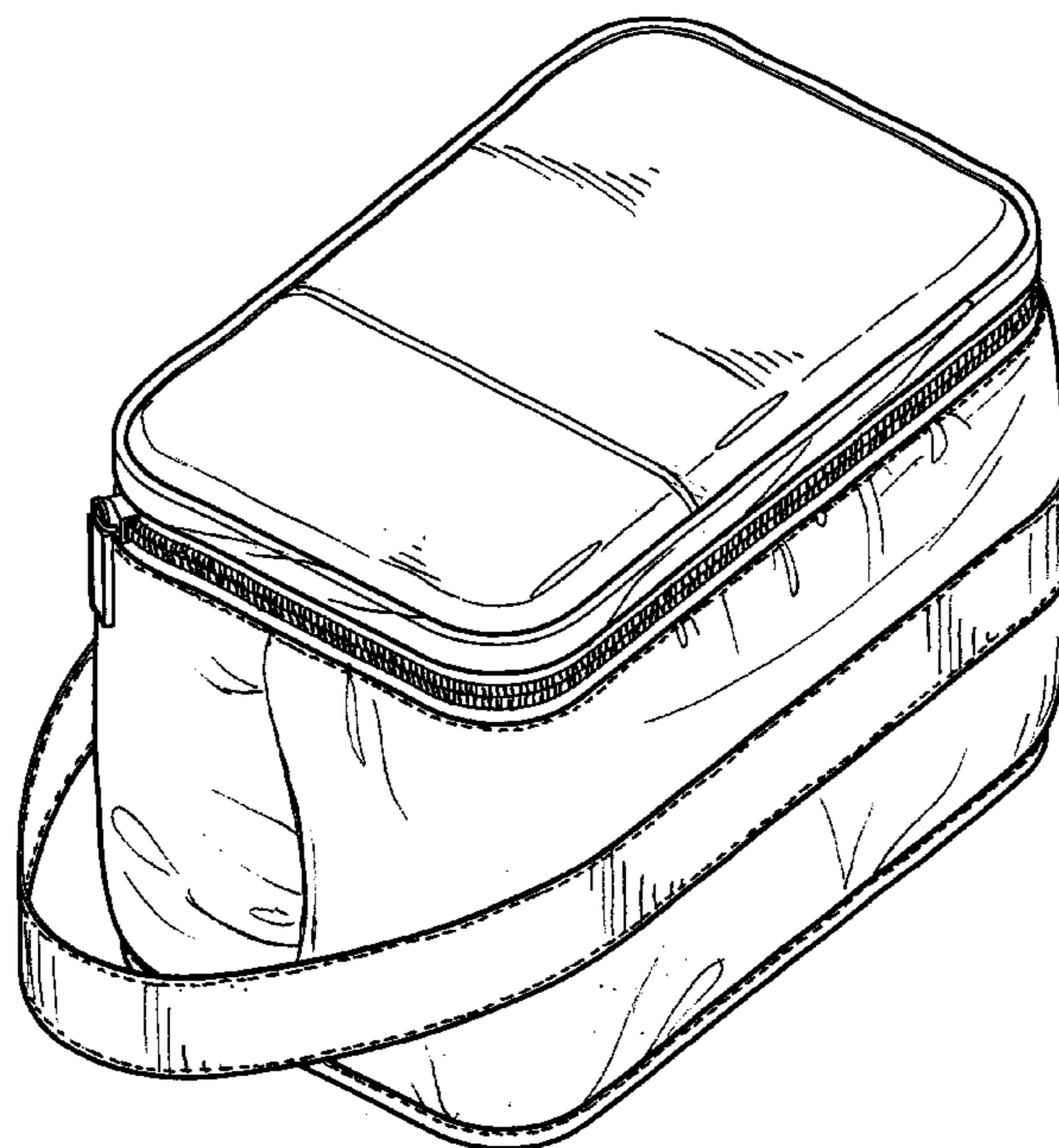

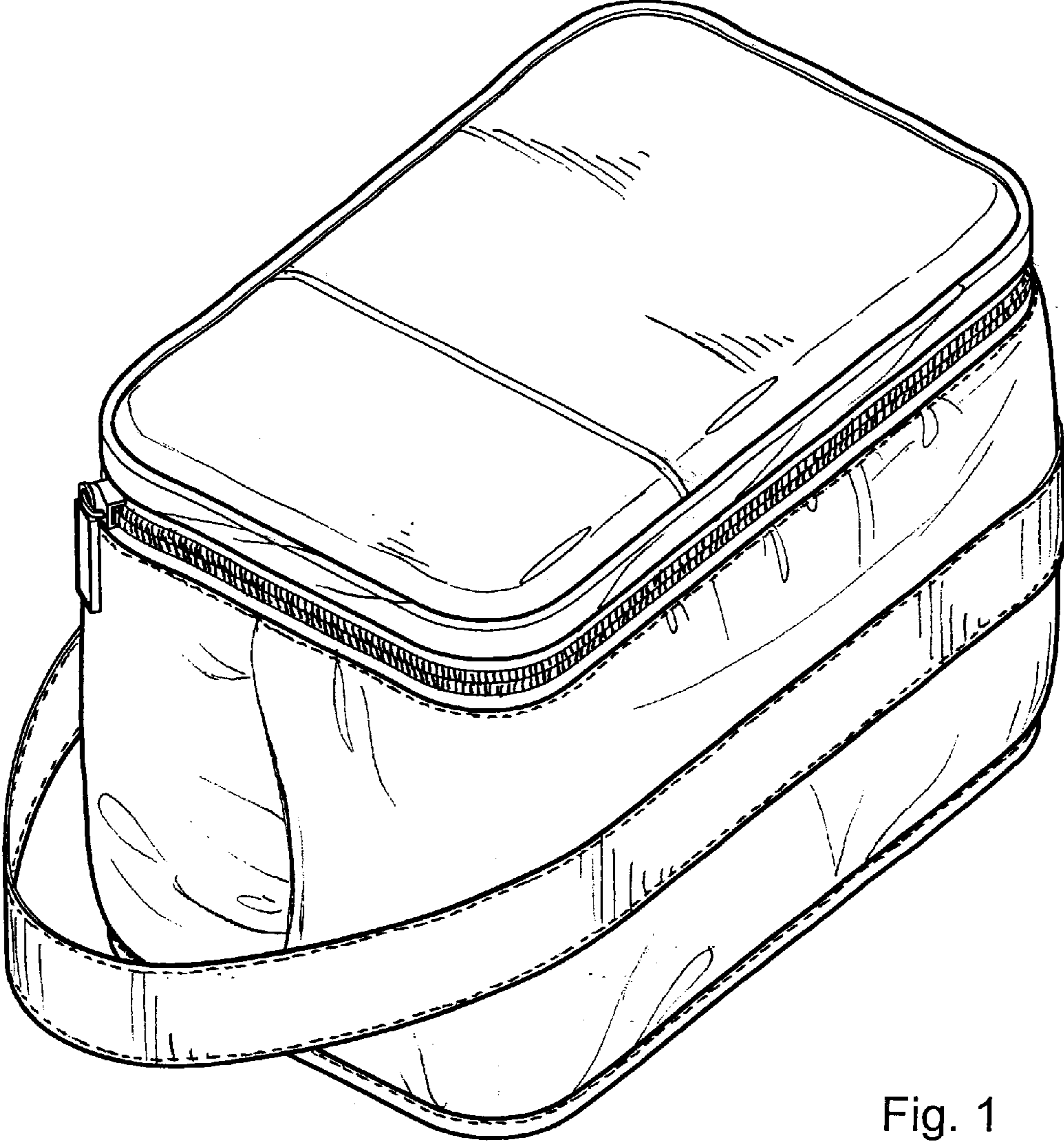

Fig. 1

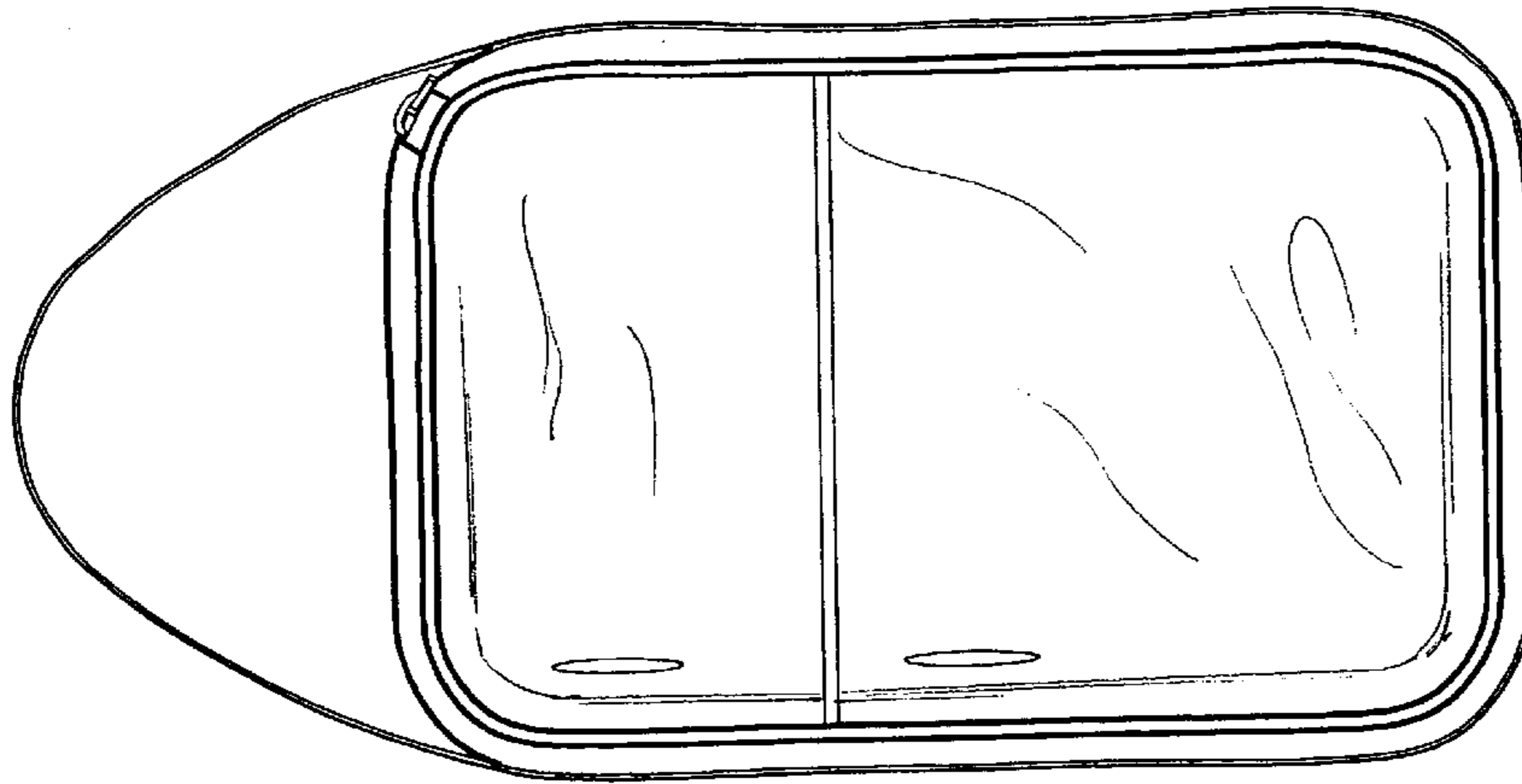

Fig. 2

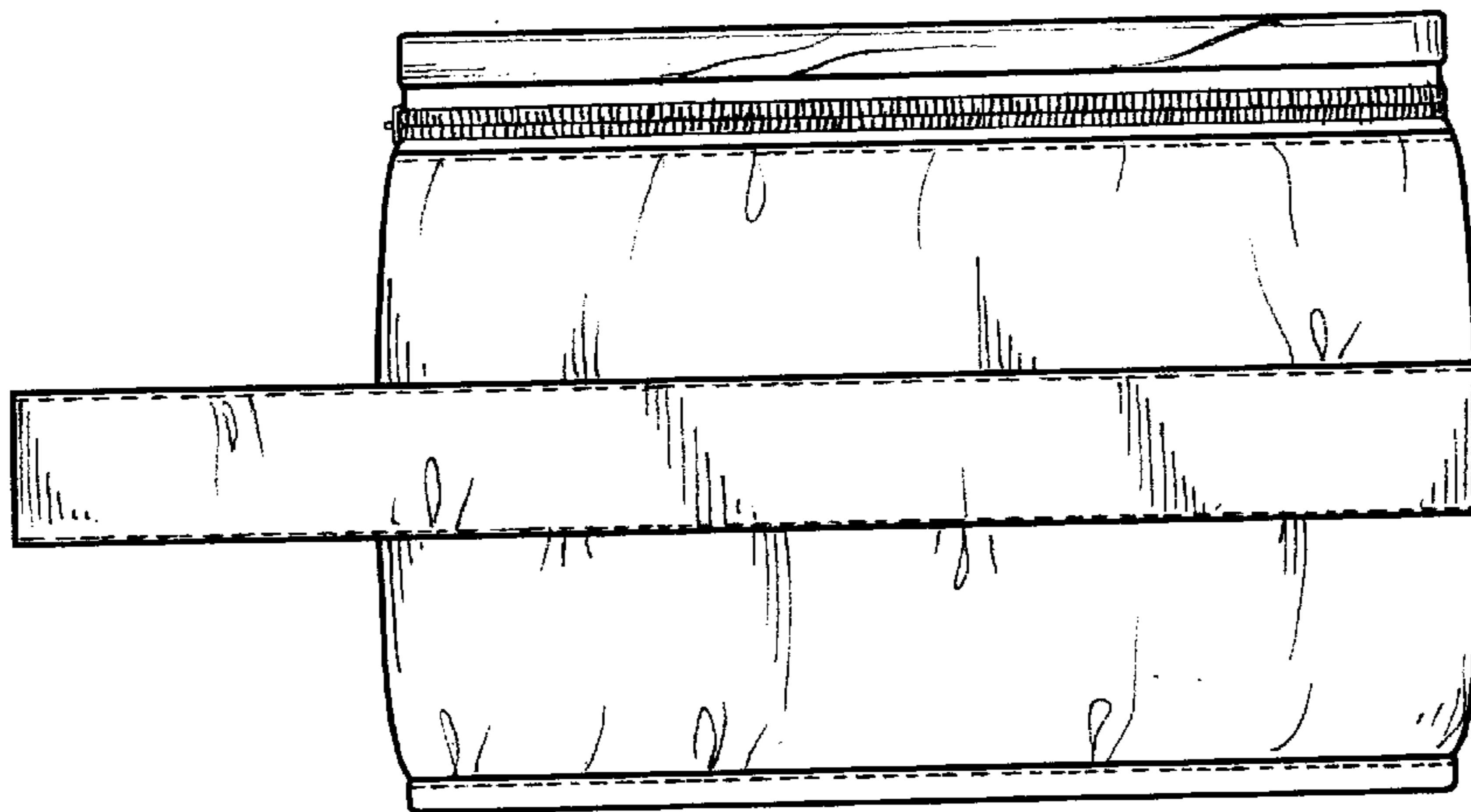

Fig. 3

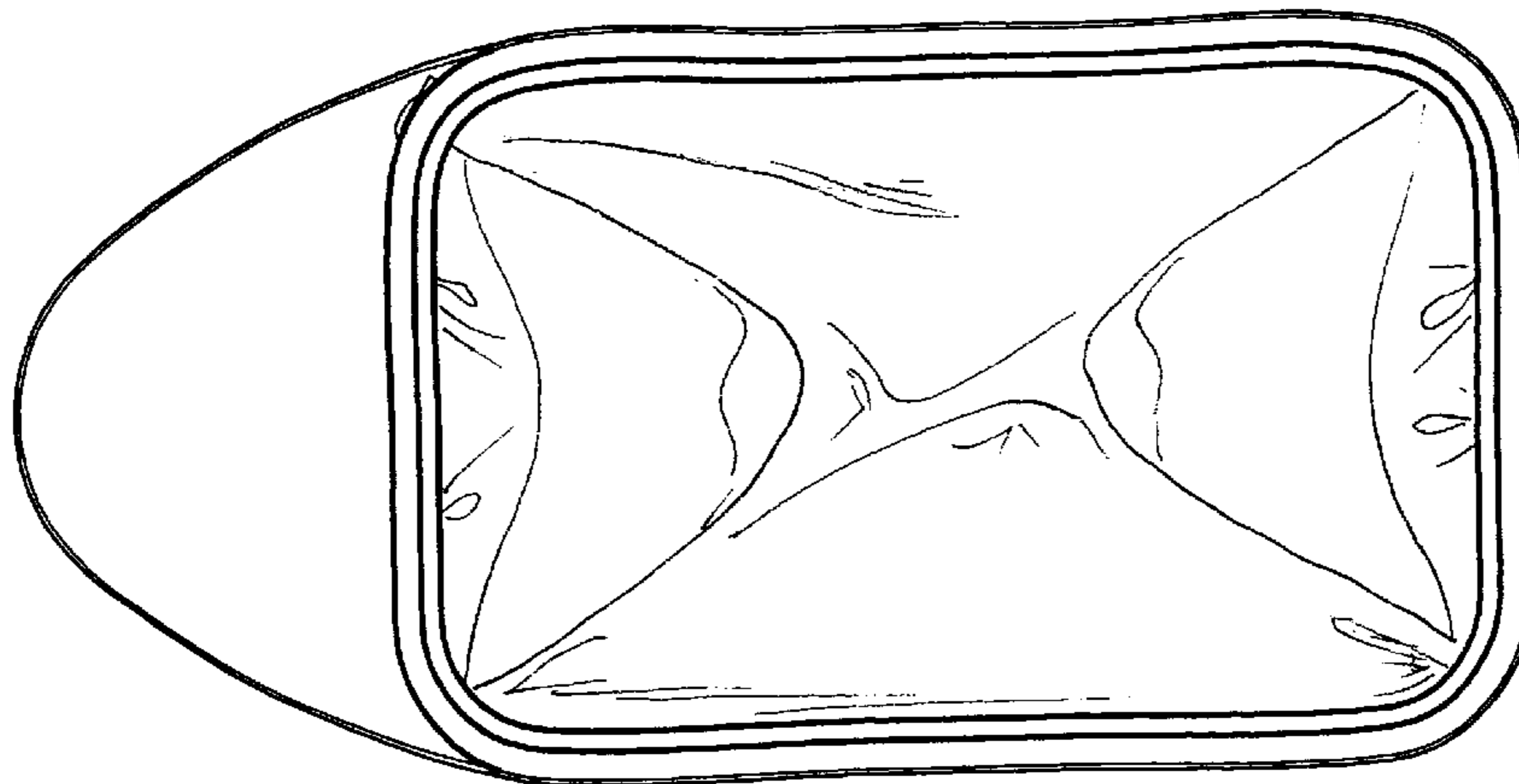

Fig. 4

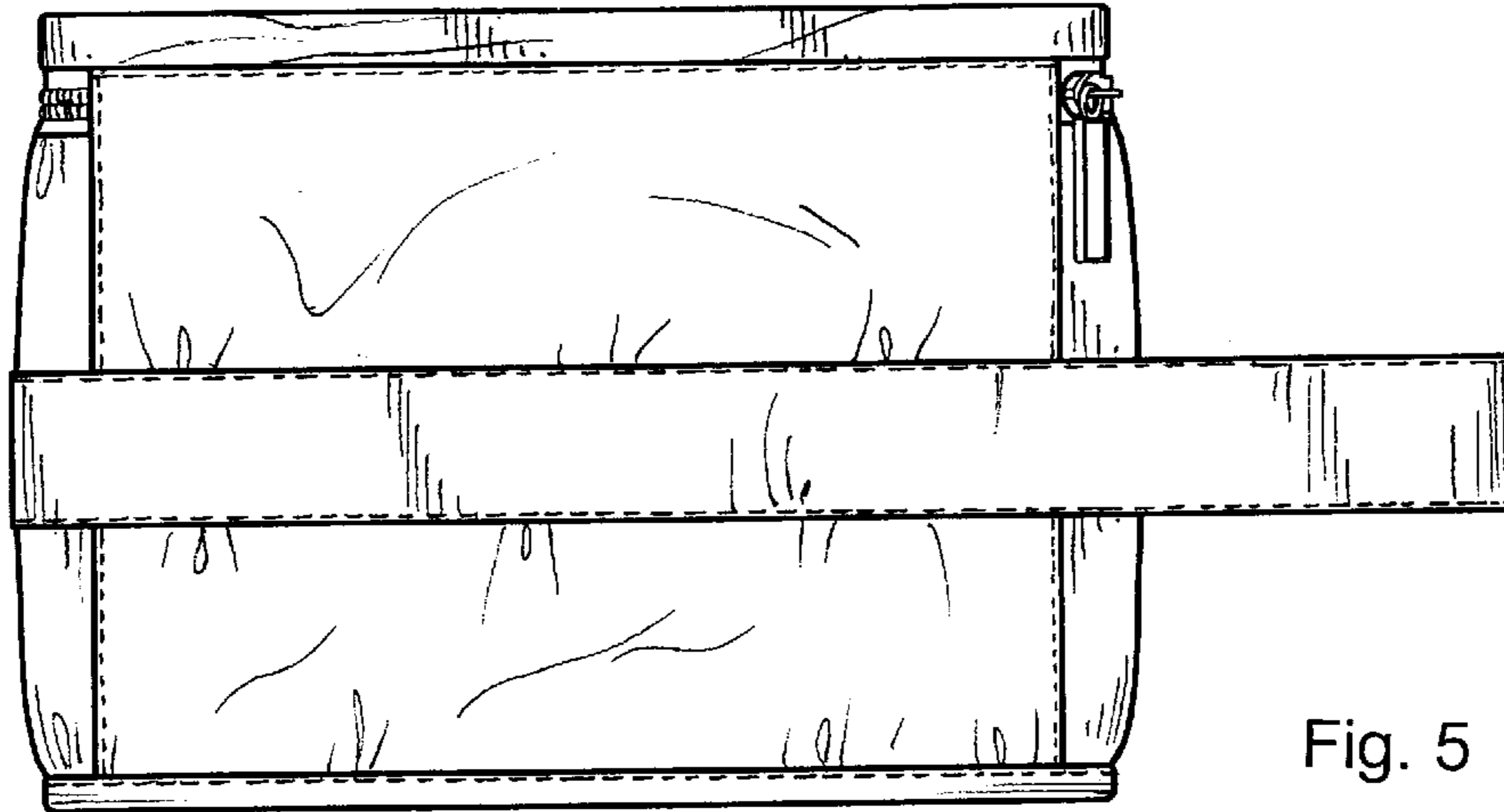

Fig. 5

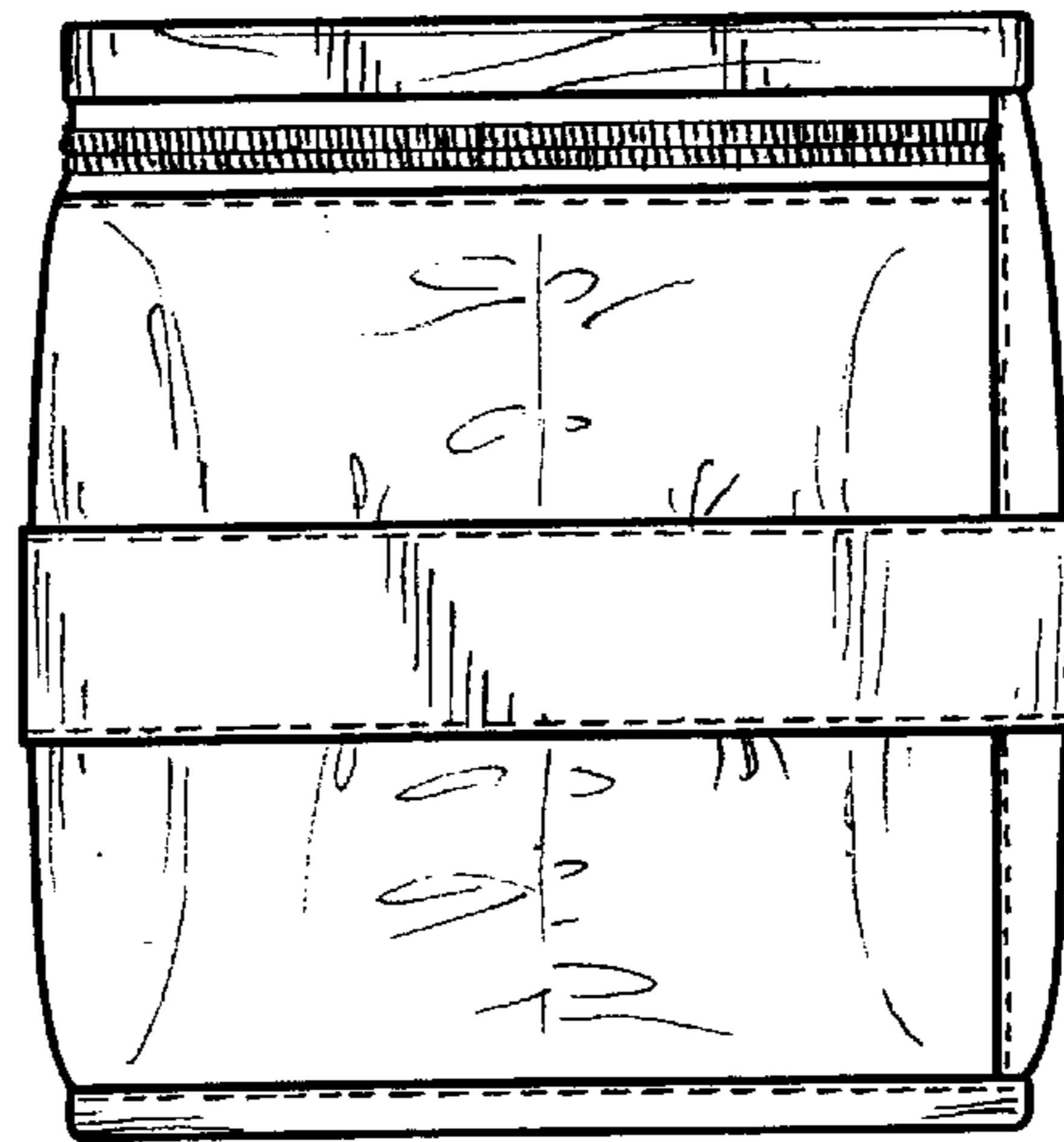

Fig. 6

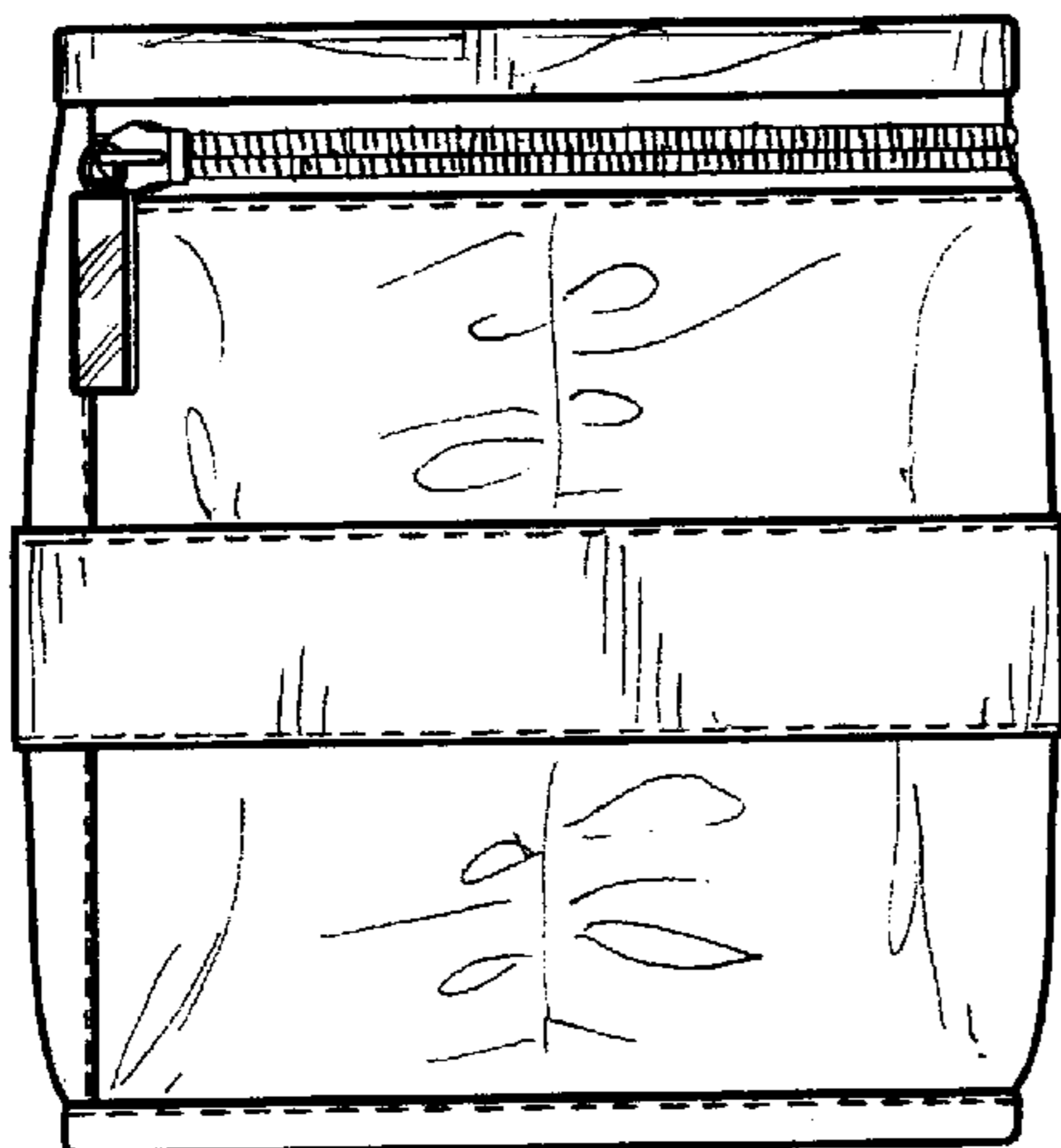

Fig. 7

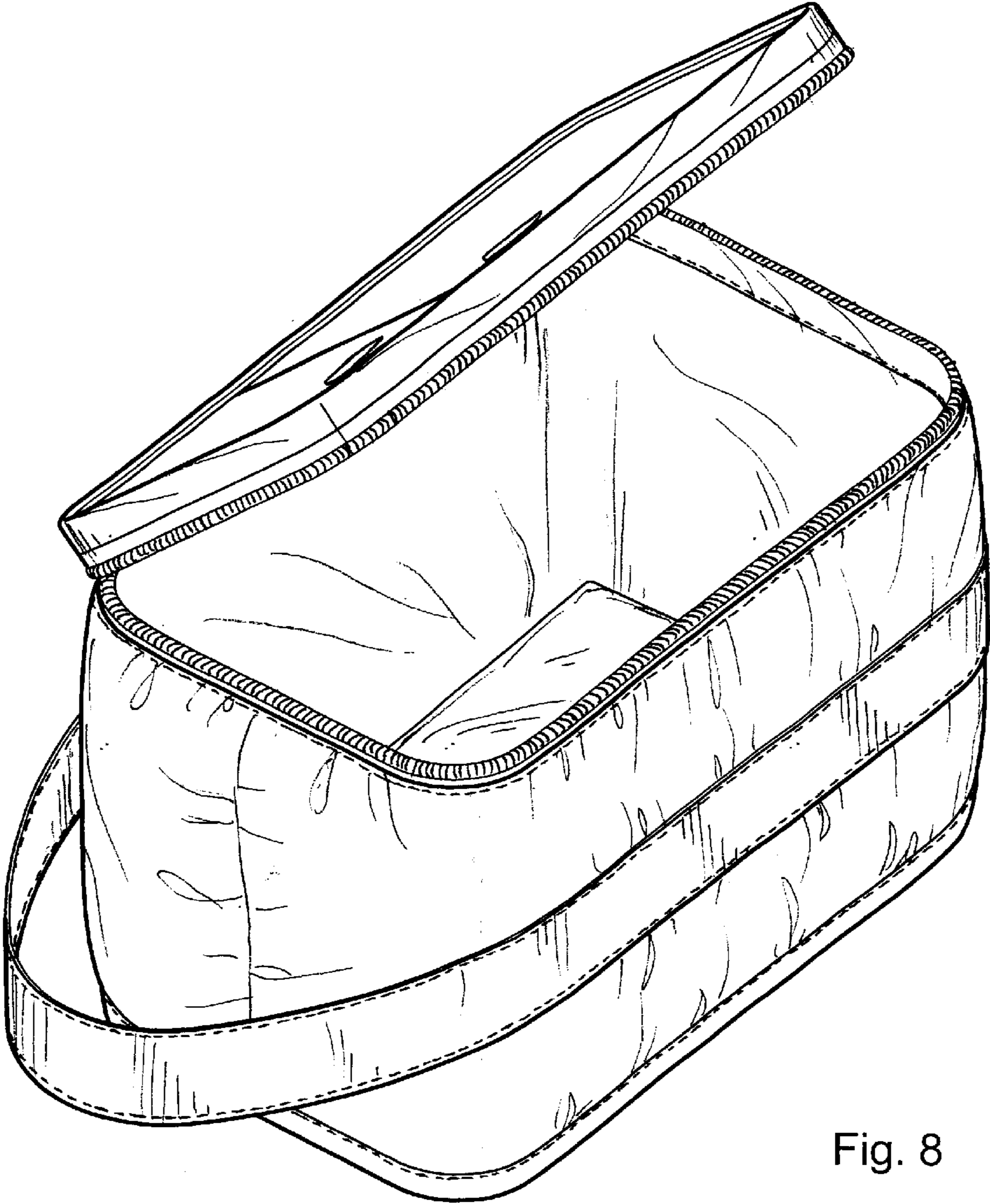

Fig. 8

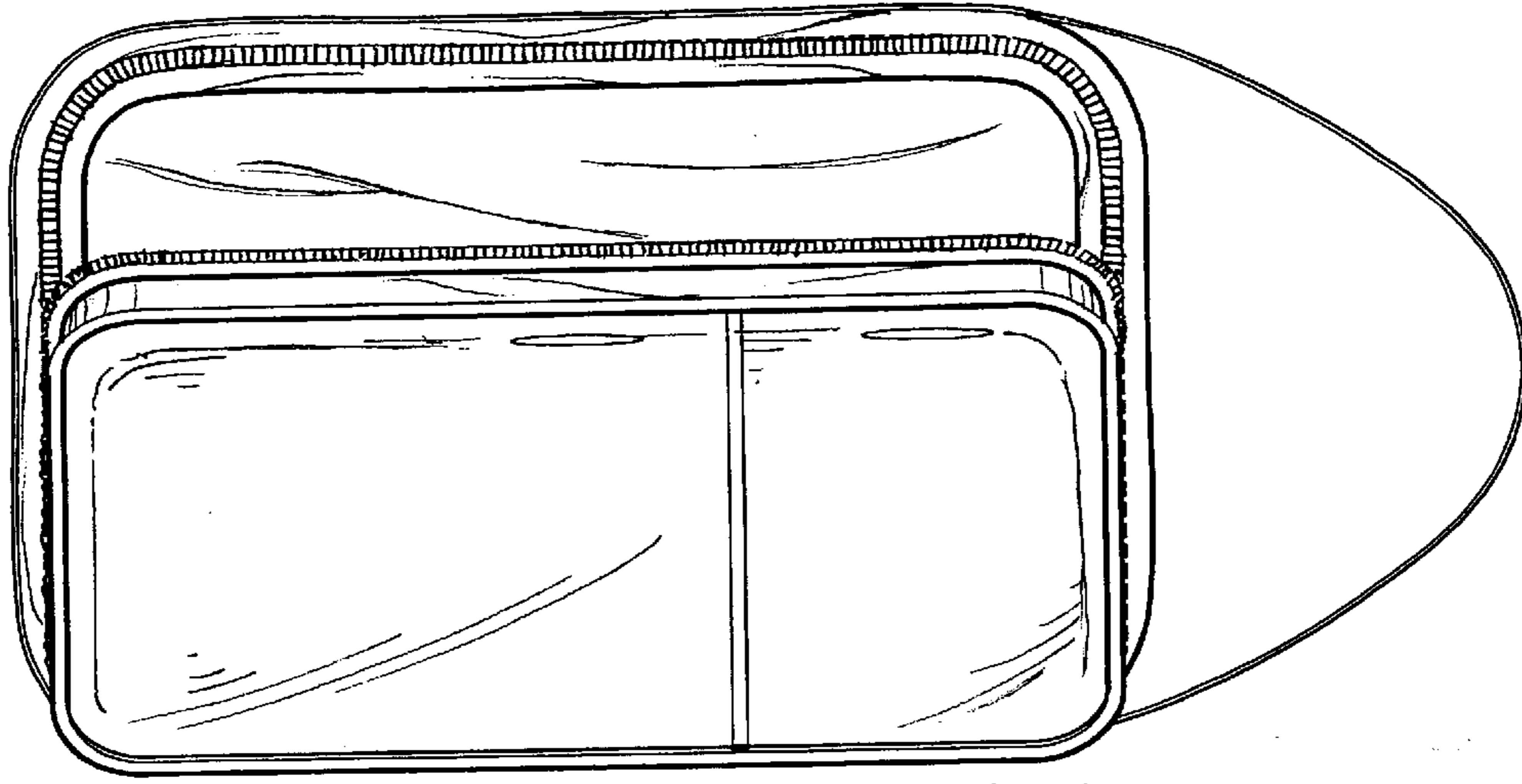

Fig. 9

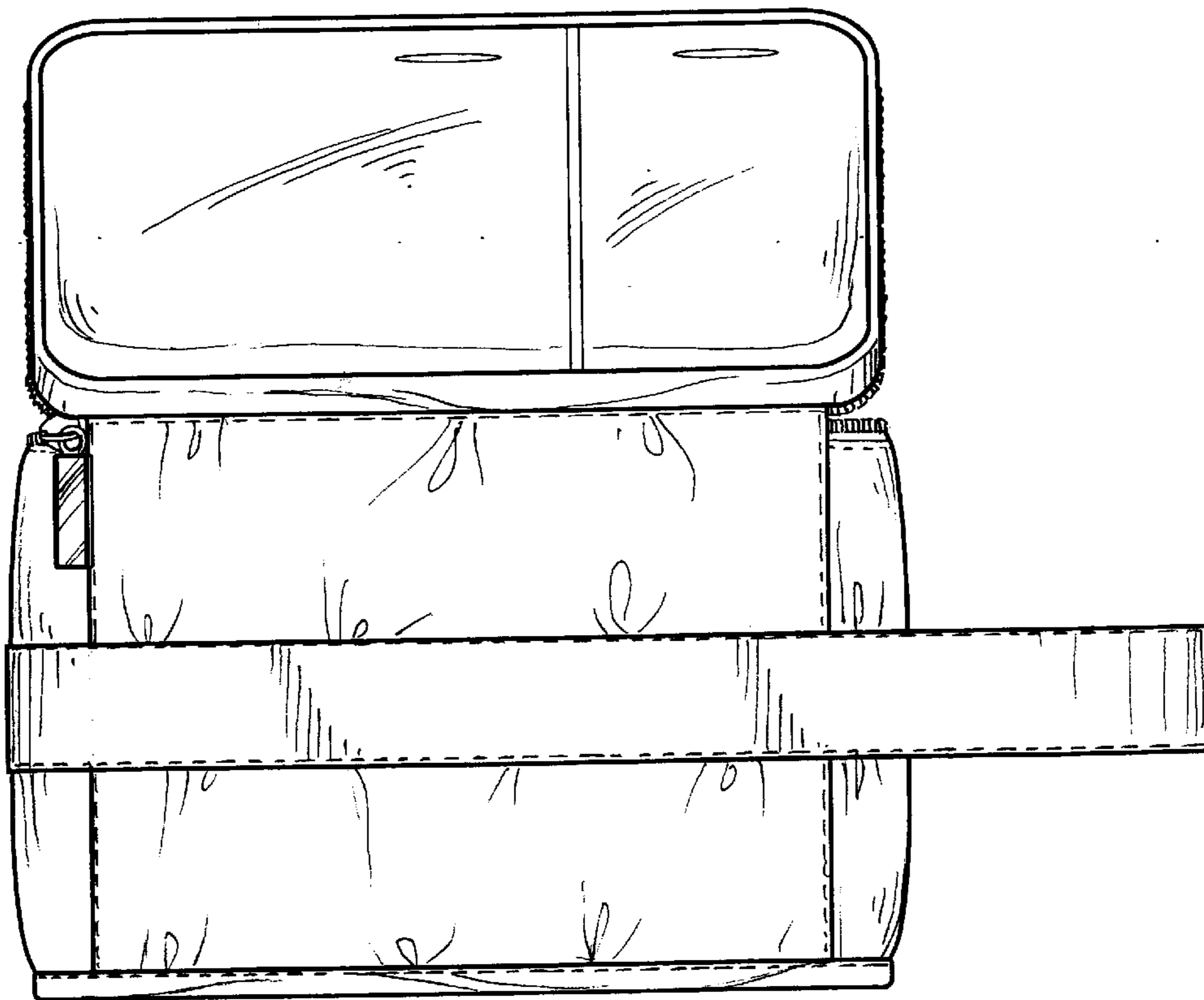

Fig. 10

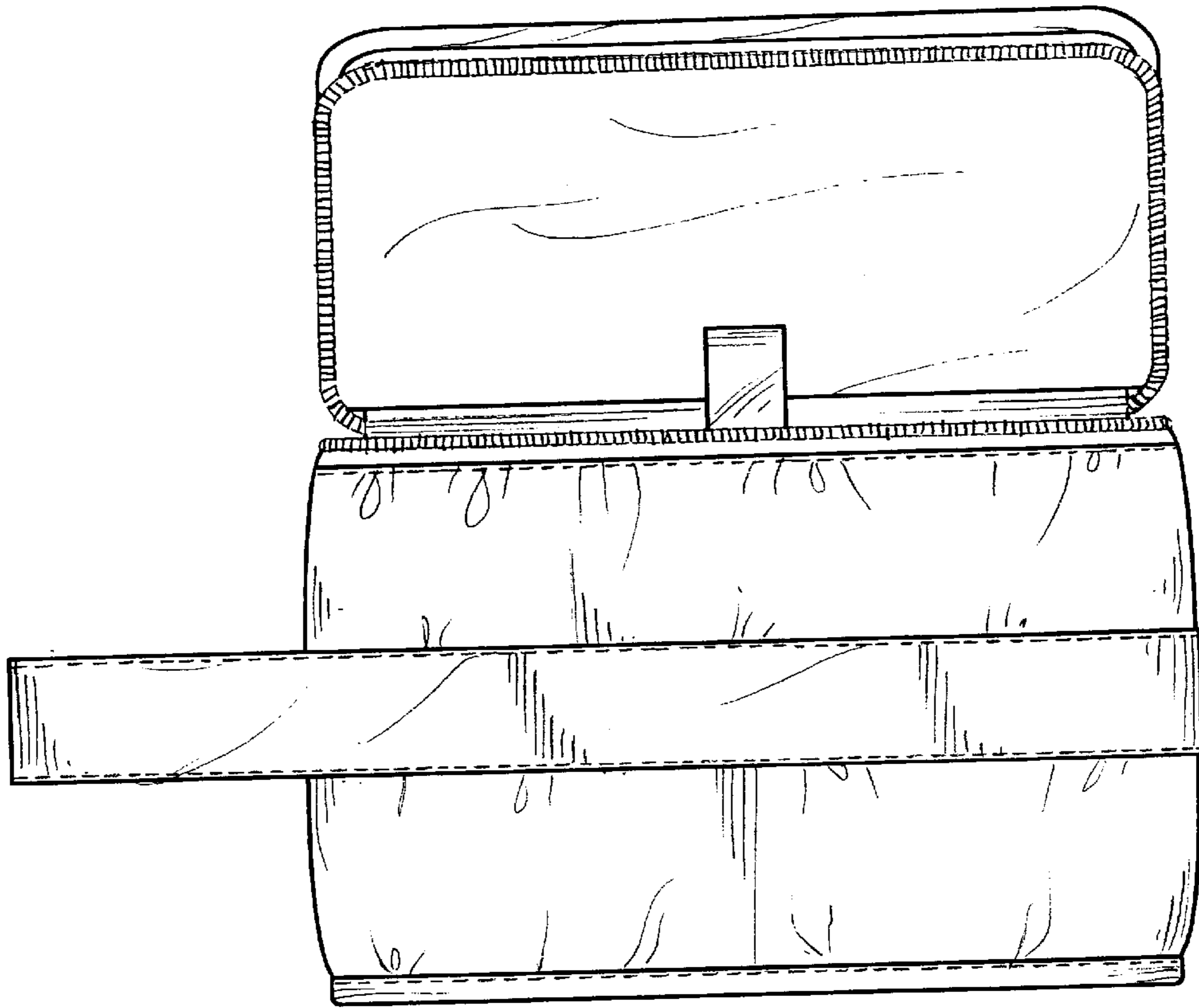

Fig. 11

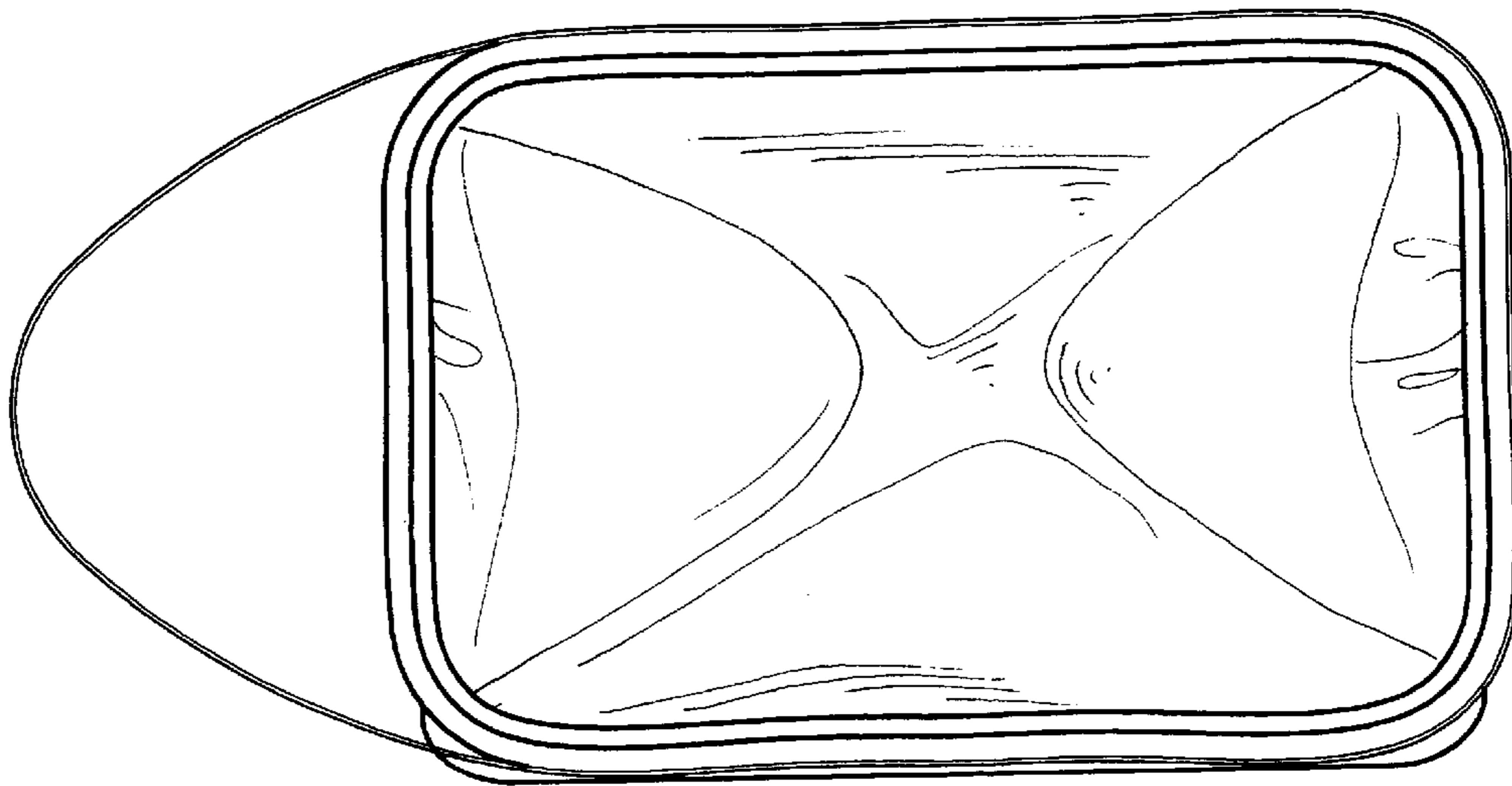

Fig. 12

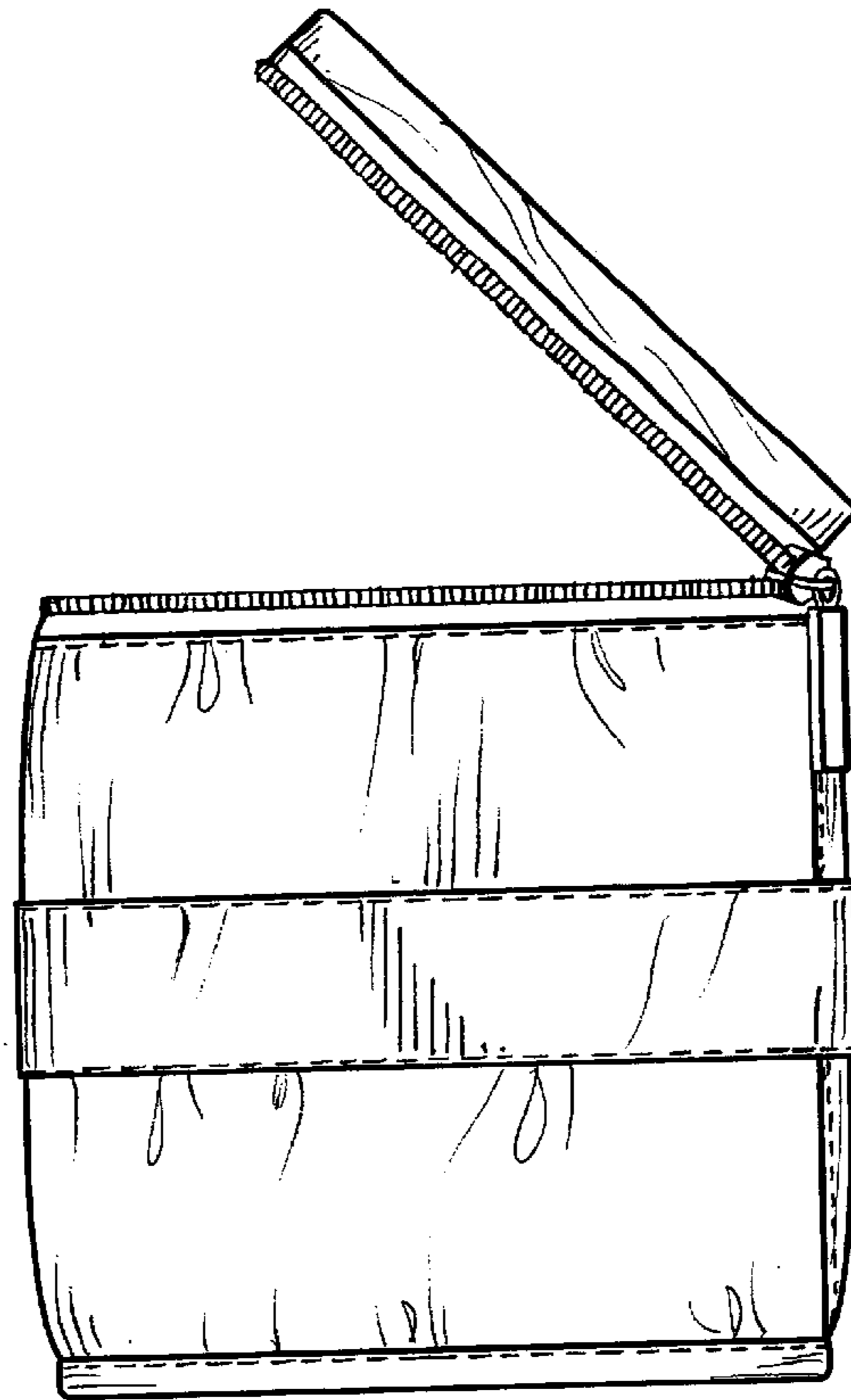

Fig. 13

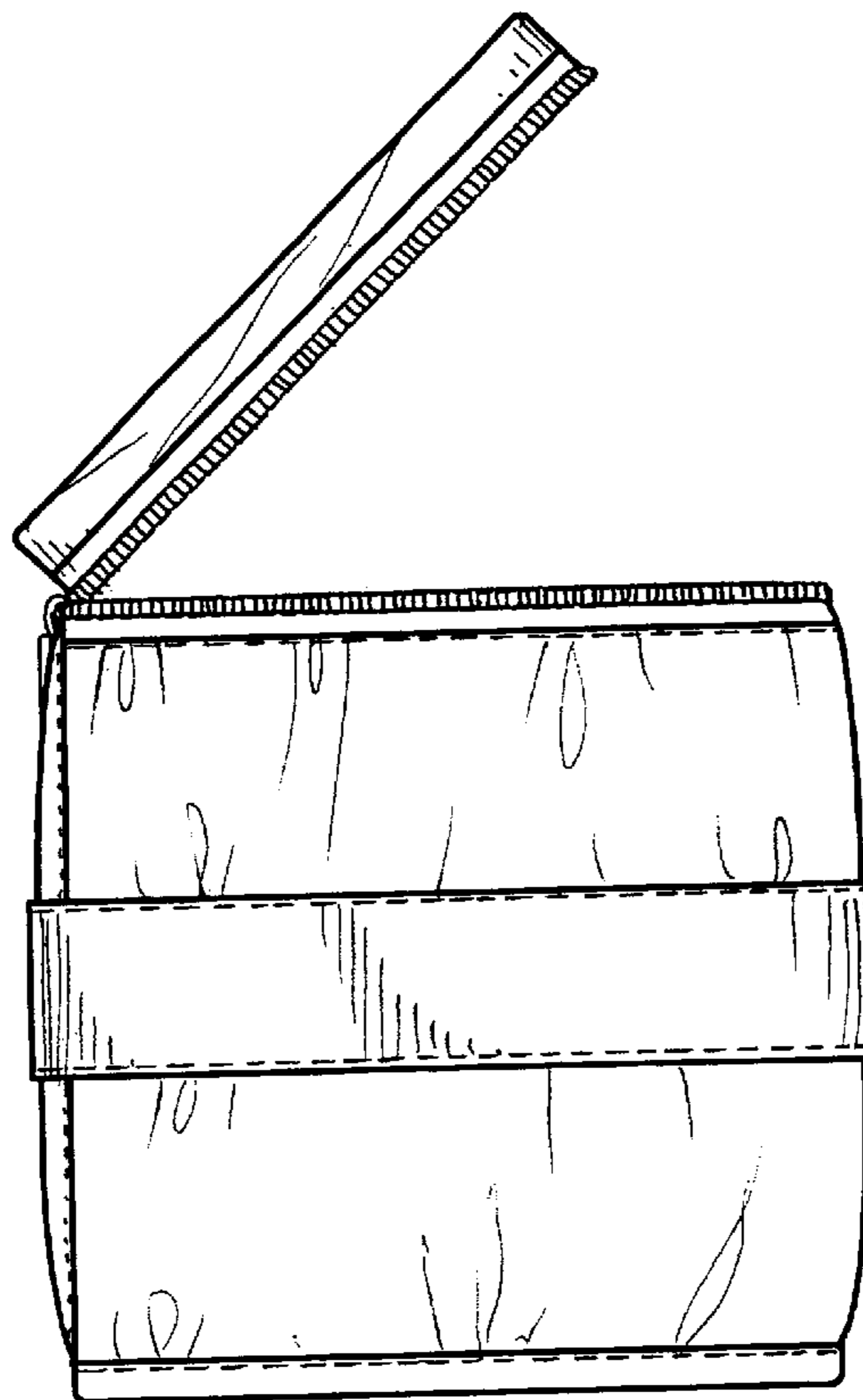

Fig. 14



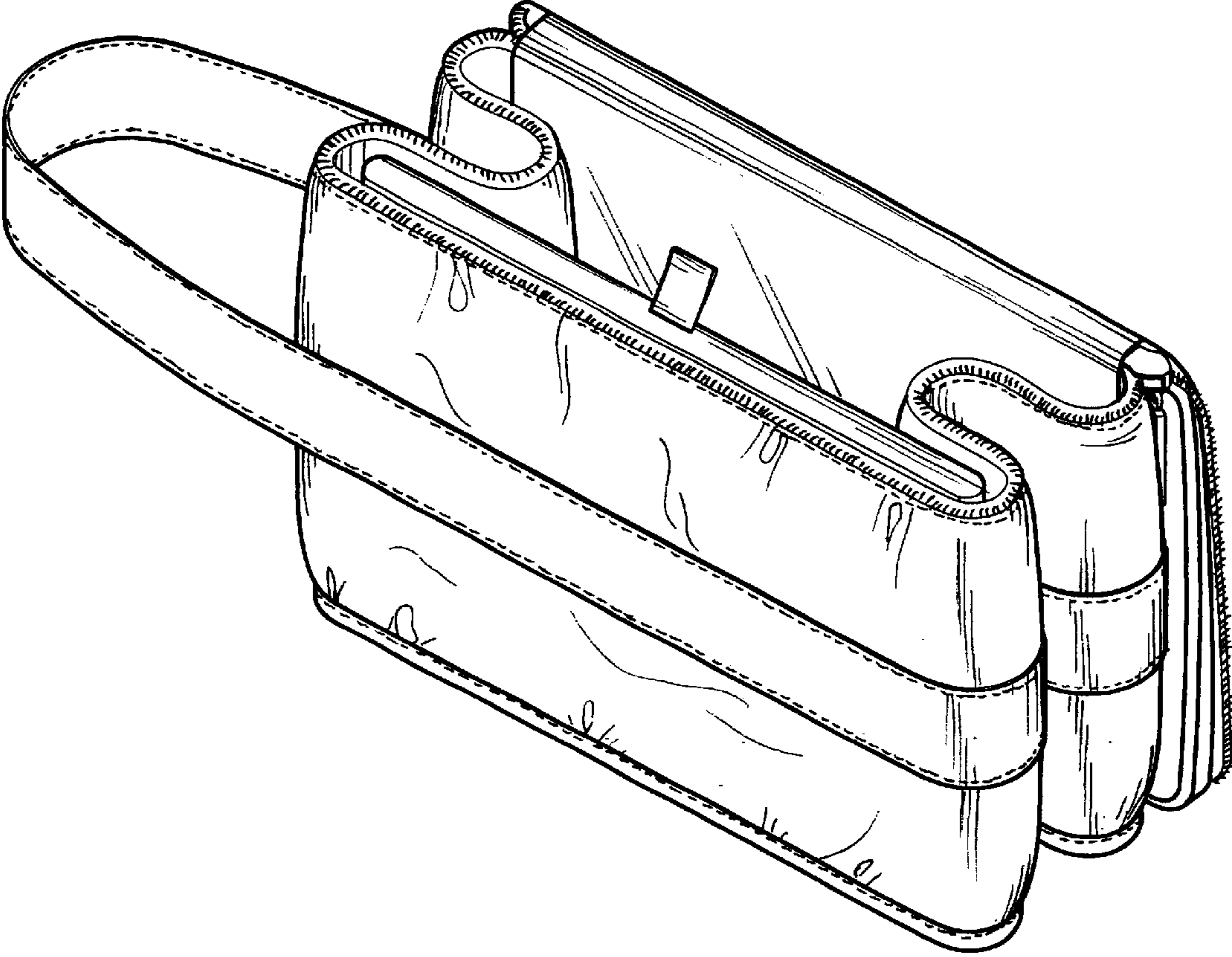

Fig. 15

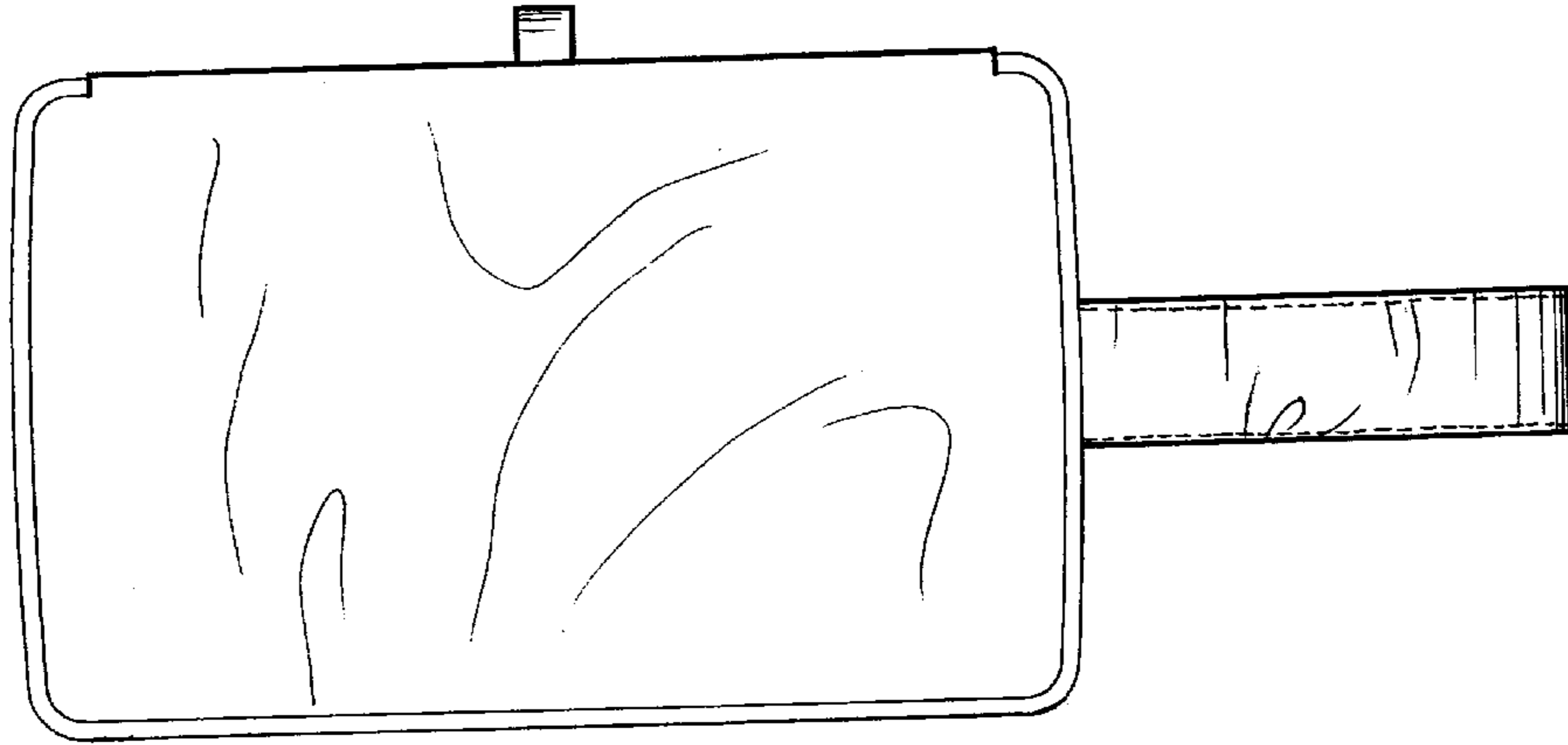

Fig. 16

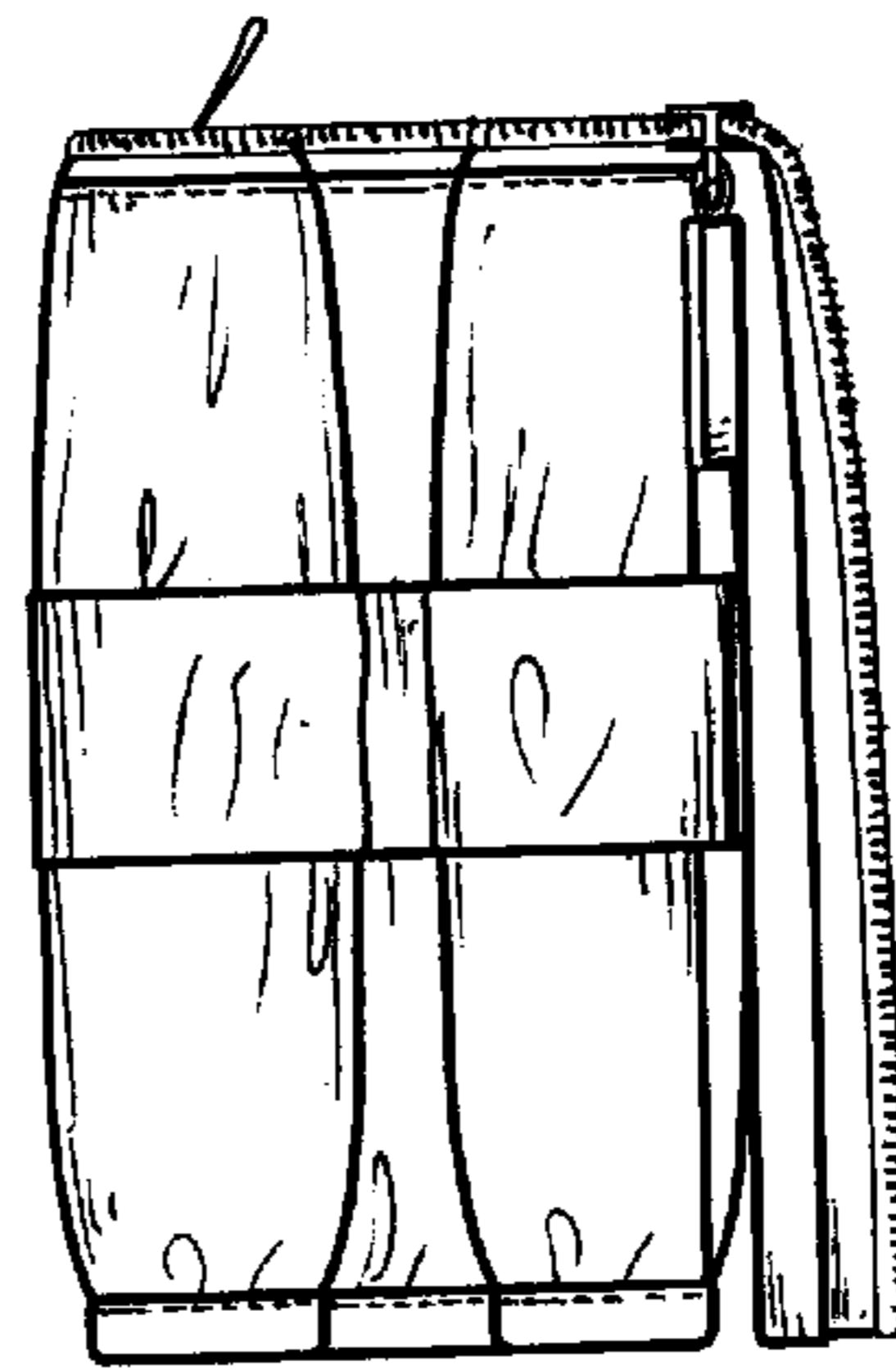

Fig. 17

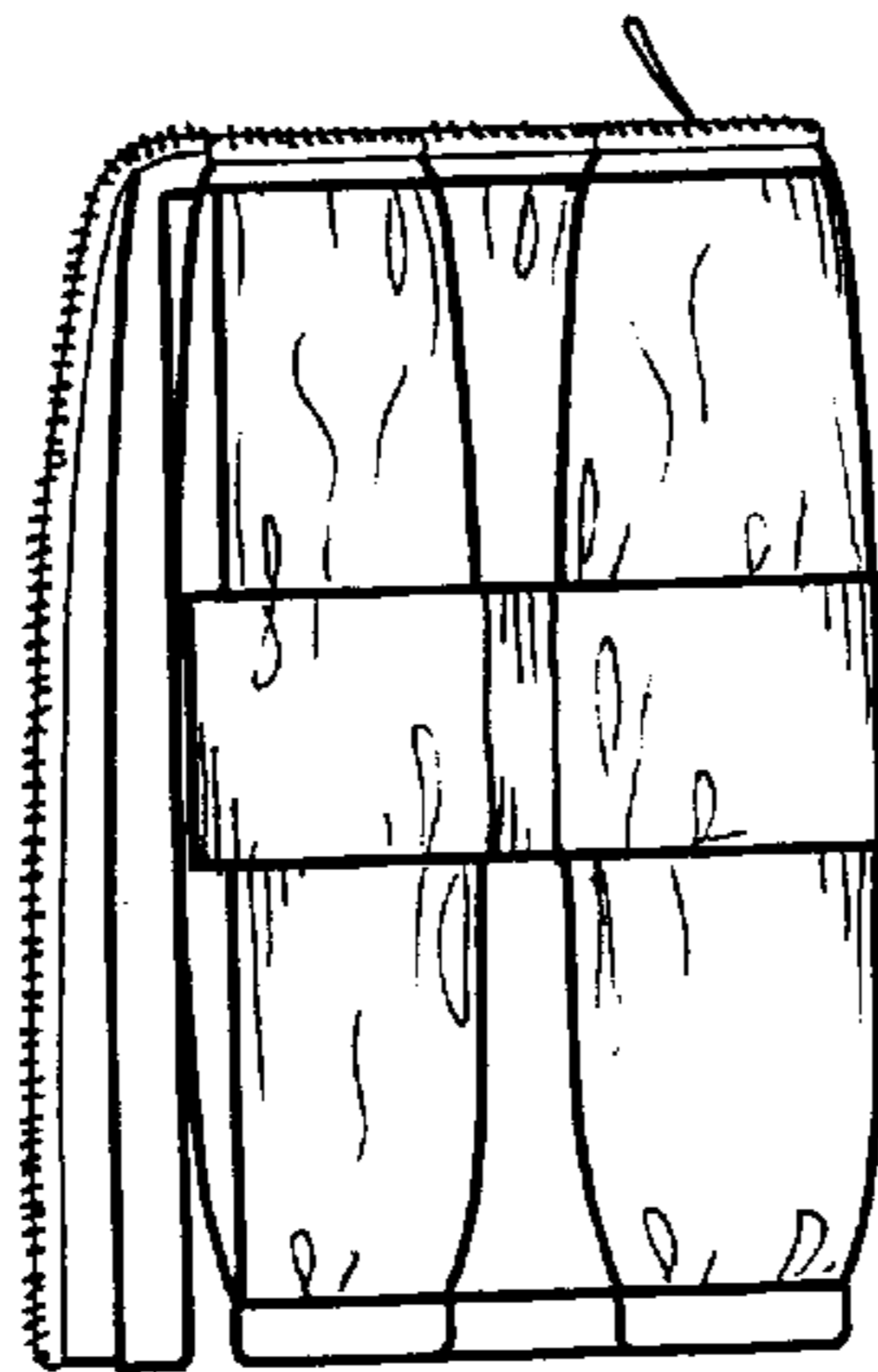

Fig. 18

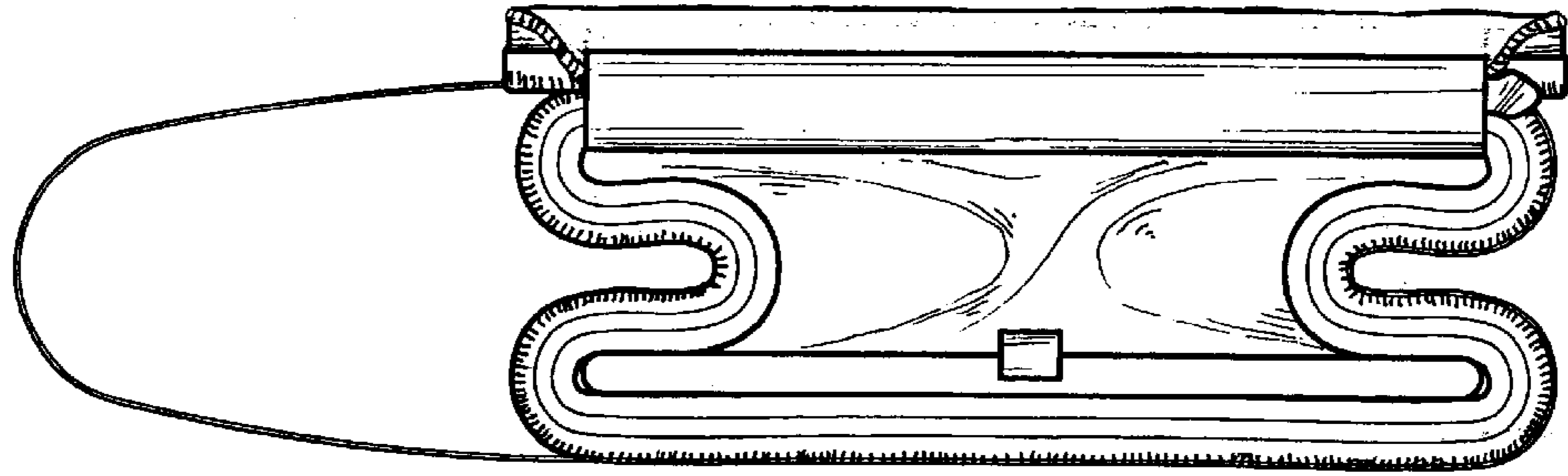

Fig. 19

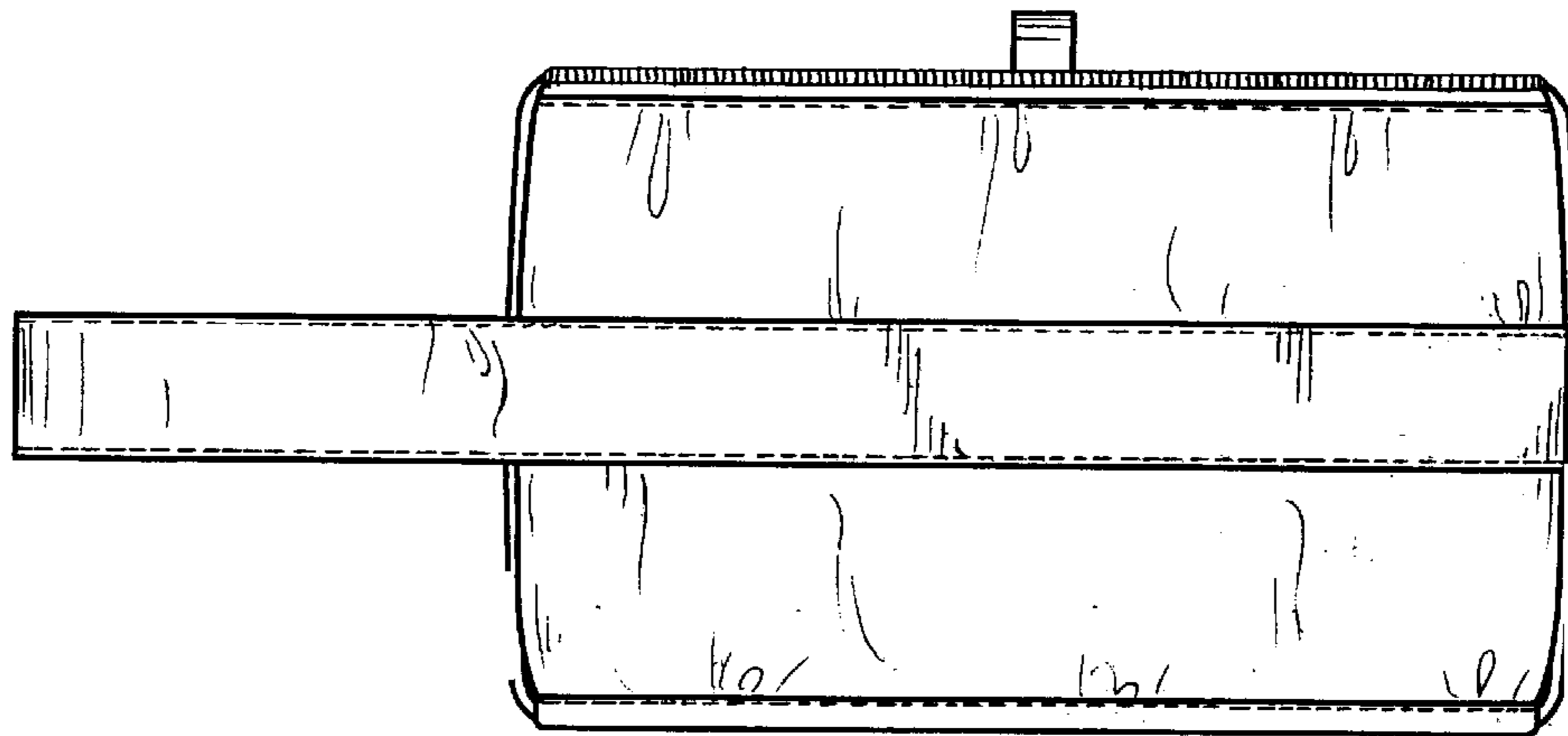

Fig. 20

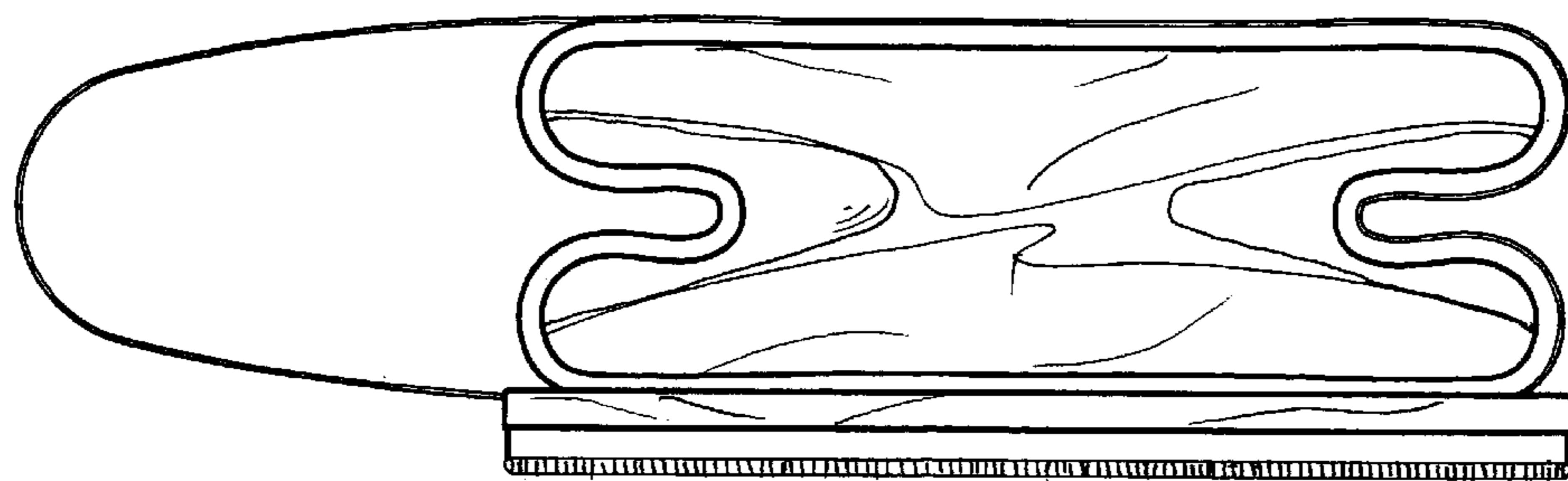

Fig. 21