

US00D515358S

(12) **United States Design Patent** (10) **Patent No.:** **US D515,358 S**
Orr et al. (45) **Date of Patent:** **** Feb. 21, 2006**

(54) **CUP** D210,767 S 4/1968 Anglada D9/220
D211,514 S 6/1968 Amberg D9/219

(75) Inventors: **David K. Orr**, Lakewood, IL (US);
Ashwin N. Shah, Fairport, NY (US);
Thomas J. Hayes, McHenry, IL (US);
Michael J. Maczuzak, Bratenahl, OH
(US); **Jeff Wolcott**, Grayslake, IL (US);
Jesse P. Carlson, Bay Village, OH
(US)

(Continued)

FOREIGN PATENT DOCUMENTS

DE	1 175 564	8/1964
DE	1 216 139	5/1966
EP	0 371 918	11/1989
FR	2 207 836	11/1973
GB	974241	11/1964
GB	1 096 451	12/1967
GB	1 251 595	10/1971
GB	1266 909	3/1972
GB	1 461 394	1/1977
GB	1 564 097	4/1980
GB	2 073 581	10/1981

(73) Assignee: **Pactiv Corporation**, Lake Forest, IL
(US)

(**) Term: **14 Years**

(21) Appl. No.: **29/215,059**

(22) Filed: **Oct. 12, 2004**

(51) **LOC (8) Cl.** **07-01**

(52) **U.S. Cl.** **D7/523; D7/532**

(58) **Field of Classification Search** D7/396.2,
D7/396.1, 531, 532, 530, 509, 523, 510;
215/10, 12.1, 382, 384, 387, DIG. 7; D9/429,
D9/556, 428; D11/143, 153; 229/103.1, 403,
229/404, 400, 106; 426/86; 206/519, 520,
206/217, 503, 505, 515; 220/645, 671, 675,
220/592.17, 780, 608, 592.16, 70; 29/401.1

See application file for complete search history.

(56) **References Cited**

U.S. PATENT DOCUMENTS

1,636,174 A	7/1927	Dolan et al.	
1,746,869 A *	2/1930	Rosenthal	29/401.1
D94,553 S *	2/1935	Marquot	D7/531
D105,431 S *	7/1937	Cobel	D7/531
2,168,186 A *	8/1939	Adamson	229/106
D187,605 S *	4/1960	Dreitzer	D7/530
3,091,360 A	5/1963	Edwards	220/97
3,126,139 A	3/1964	Schechter	229/1.5
3,128,029 A *	4/1964	Price et al.	229/400
3,139,213 A	6/1964	Edwards	220/97
D199,579 S	11/1964	Davis	D44/9
3,288,340 A	11/1966	Shapiro et al.	229/1.5
3,342,370 A	9/1967	Johnson	220/97

OTHER PUBLICATIONS

Photograph of Hefty 16 oz cup having textured sidewall, date circa 1988.

Photograph of 8 oz. cup with textured ring on sidewall, date unknown.

Photograph of 8 oz cup having Northwest Airlines insignia and textured sidewall, date unknown.

Primary Examiner—M. N. Pandozzi

(74) *Attorney, Agent, or Firm*—Winston & Strawn LLP

(57) **CLAIM**

The ornamental design for a cup, as shown.

DESCRIPTION

FIG. 1 is a perspective view of the cup;
FIG. 2 is a side view of the cup of FIG. 1;
FIG. 3 is a top view of the cup of FIG. 1;
FIG. 4 is a bottom view of the cup of FIG. 1;
FIG. 5 is a perspective view of another embodiment of the cup;
FIG. 6 is a side view of the cup of FIG. 5;
FIG. 7 is a top view of the cup of FIG. 5; and,
FIG. 8 is a bottom view of the cup of FIG. 5.

1 Claim, 6 Drawing Sheets

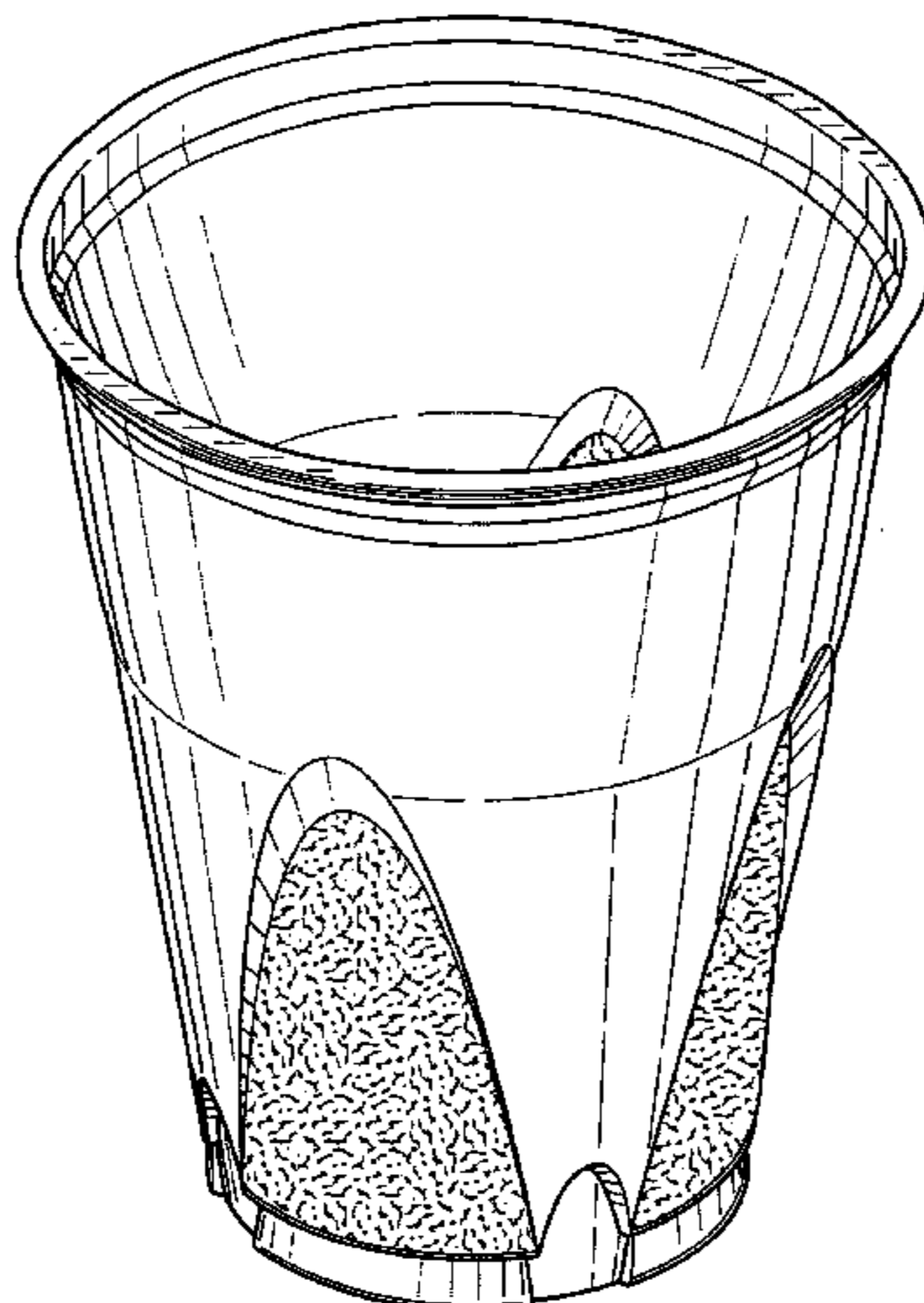

US D515,358 S

Page 2

U.S. PATENT DOCUMENTS

D213,094 S	1/1969	Davis	D9/220	D299,625 S	*	1/1989	Durand	D11/153
D213,174 S	1/1969	Davis	D9/220	D320,744 S	*	10/1991	Palisin, Jr.	D9/429
3,437,253 A	4/1969	Davis et al.	229/1.5	D320,745 S	*	10/1991	Palisin, Jr.	D9/429
3,443,714 A	* 5/1969	Edwards	220/671	D321,652 S	*	11/1991	Palisin, Jr.	D9/429
D223,999 S	* 6/1972	Klose	D9/429	D322,032 S	*	12/1991	Palisin, Jr.	D9/429
3,910,414 A	* 10/1975	McCay	206/515	5,415,339 A		5/1995	Howard	229/403
D239,358 S	* 3/1976	Kjellquist	D7/523	D369,519 S	*	5/1996	Wilson	D7/523
4,061,782 A	12/1977	Baxter	426/86	D428,307 S	*	7/2000	Yeandel	D7/531
D253,872 S	* 1/1980	Reynolds	D9/428	D452,415 S	*	12/2001	McDonough et al.	D7/510
4,245,685 A	1/1981	Nemitz et al.	150/52	D483,613 S	*	12/2003	Gluck	D7/531
4,261,501 A	4/1981	Watkins et al.	229/1.5	D484,362 S	*	12/2003	Harris et al.	D7/531
4,420,081 A	12/1983	Dart	206/519	D499,934 S		12/2004	Smith et al.	D7/396.2
D275,252 S	* 8/1984	Durand	D7/530	D499,935 S		12/2004	Smith et al.	D7/396.2
D293,869 S	* 1/1988	Durand	D7/531	2003/0157224 A1		8/2003	Westerhof et al.	426/394
D294,911 S	* 3/1988	Durand	D7/531	2005/0061821 A1		3/2005	Smith et al.	220/675
D299,320 S	* 1/1989	Durand	D11/153					

* cited by examiner

FIG. 1

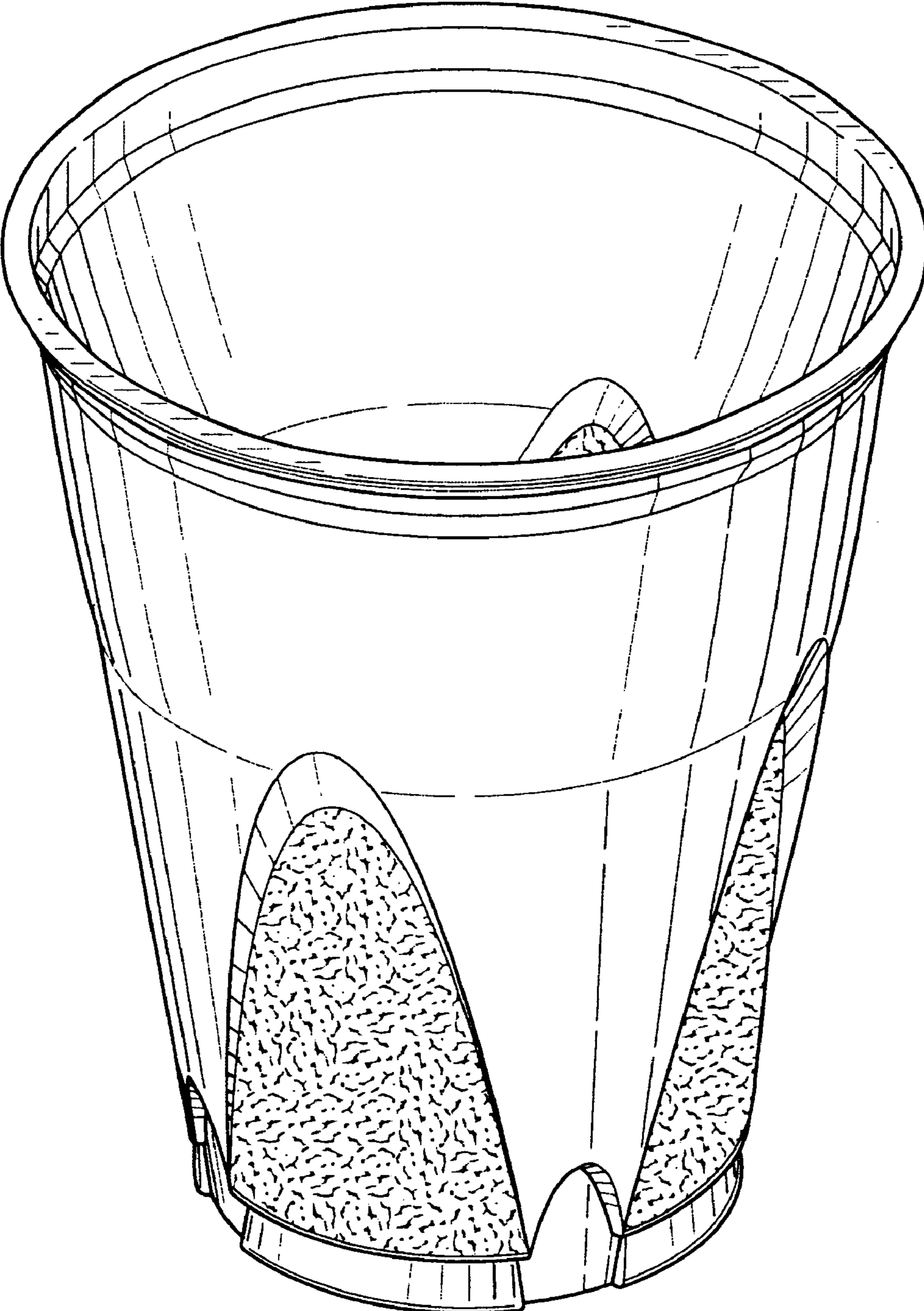

FIG. 2

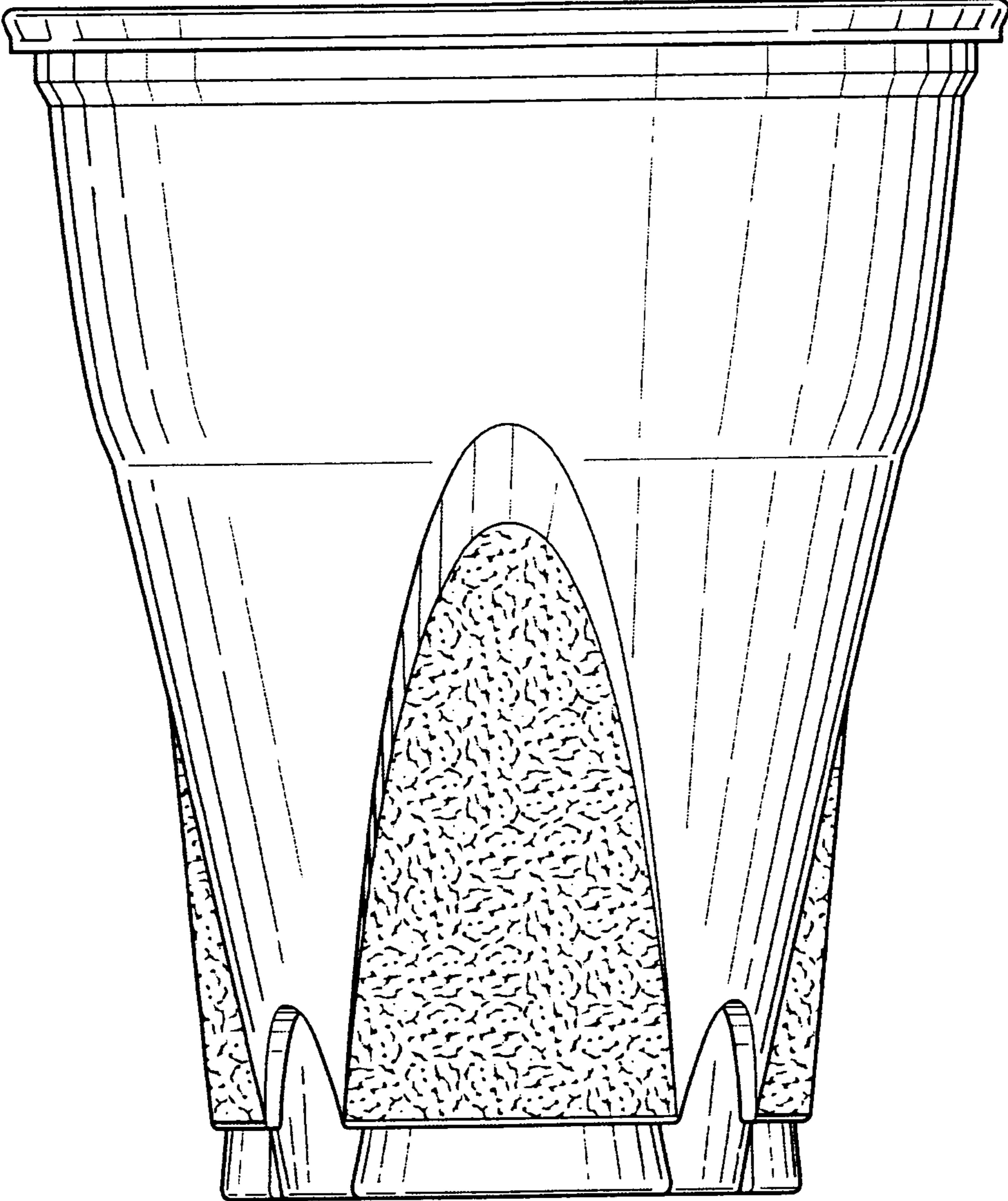

FIG. 3

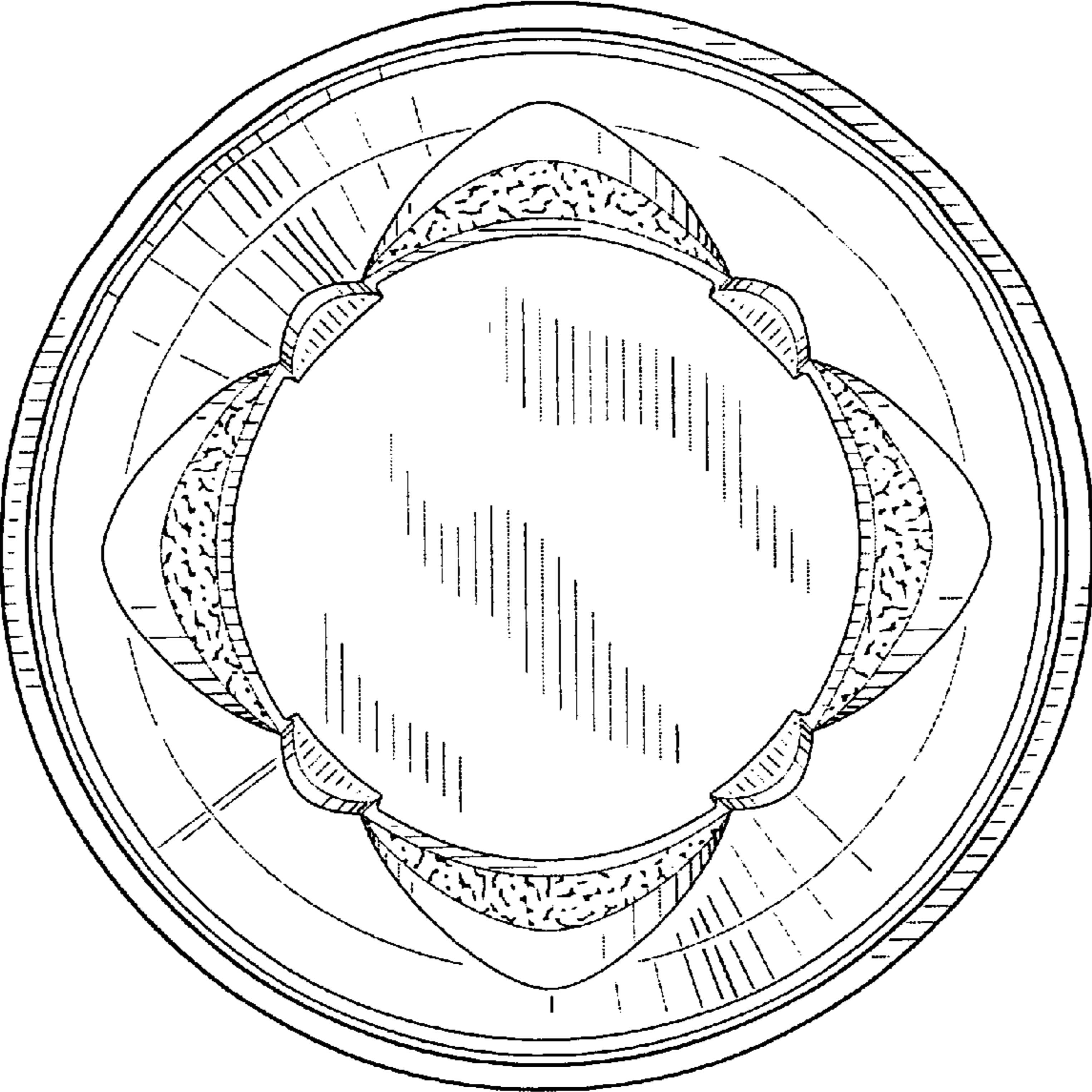

FIG. 4

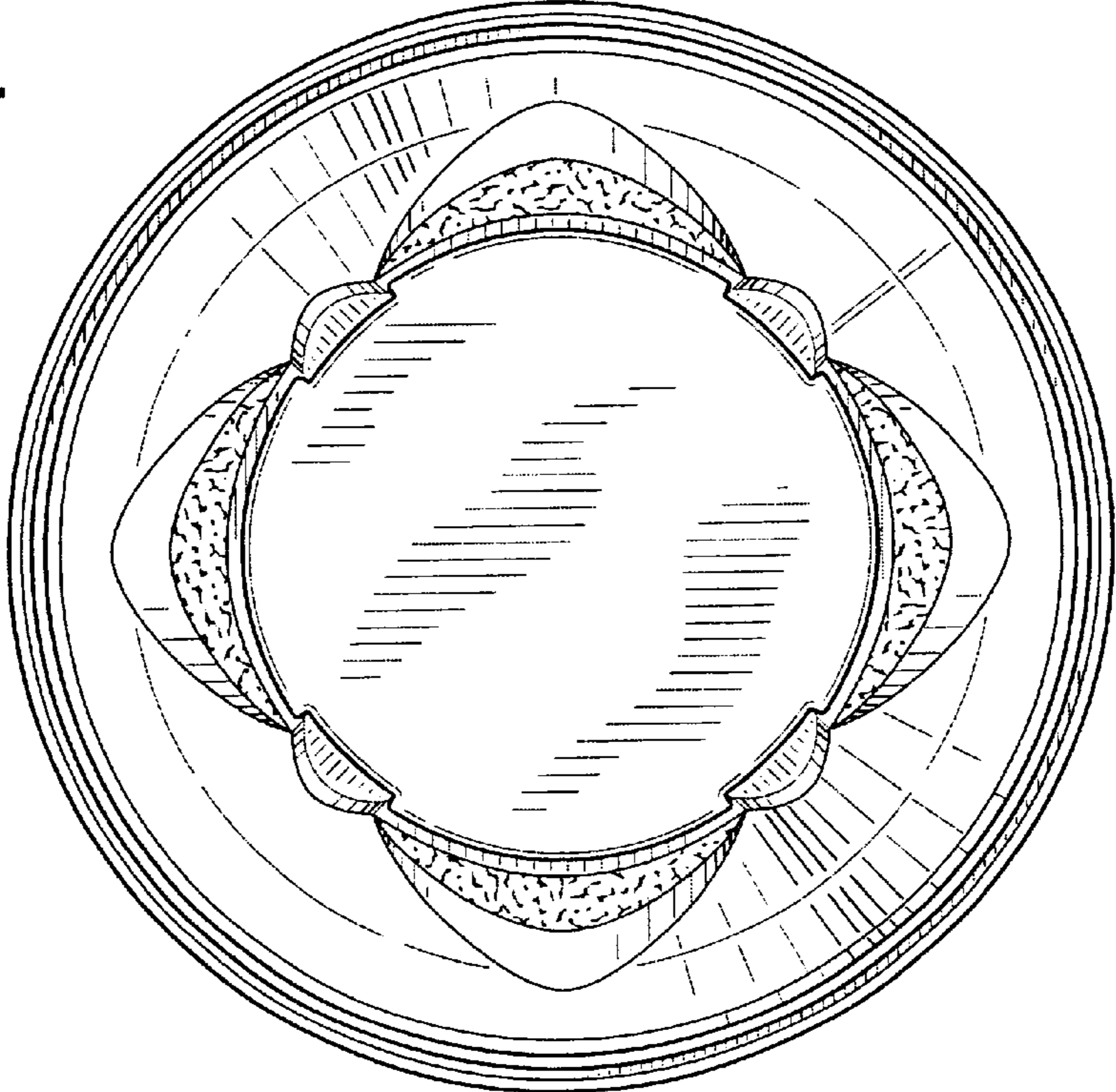

FIG. 5

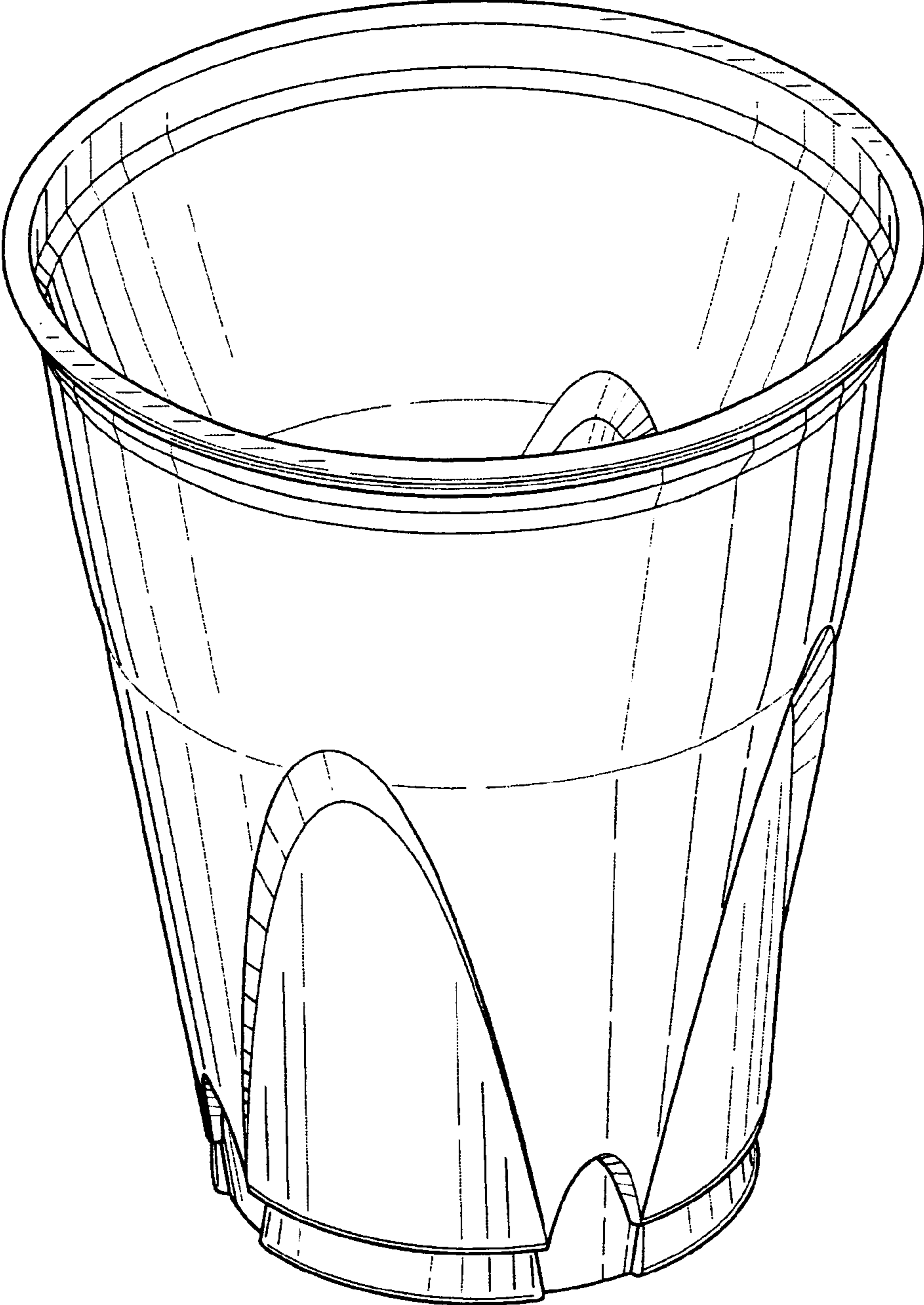

FIG. 6

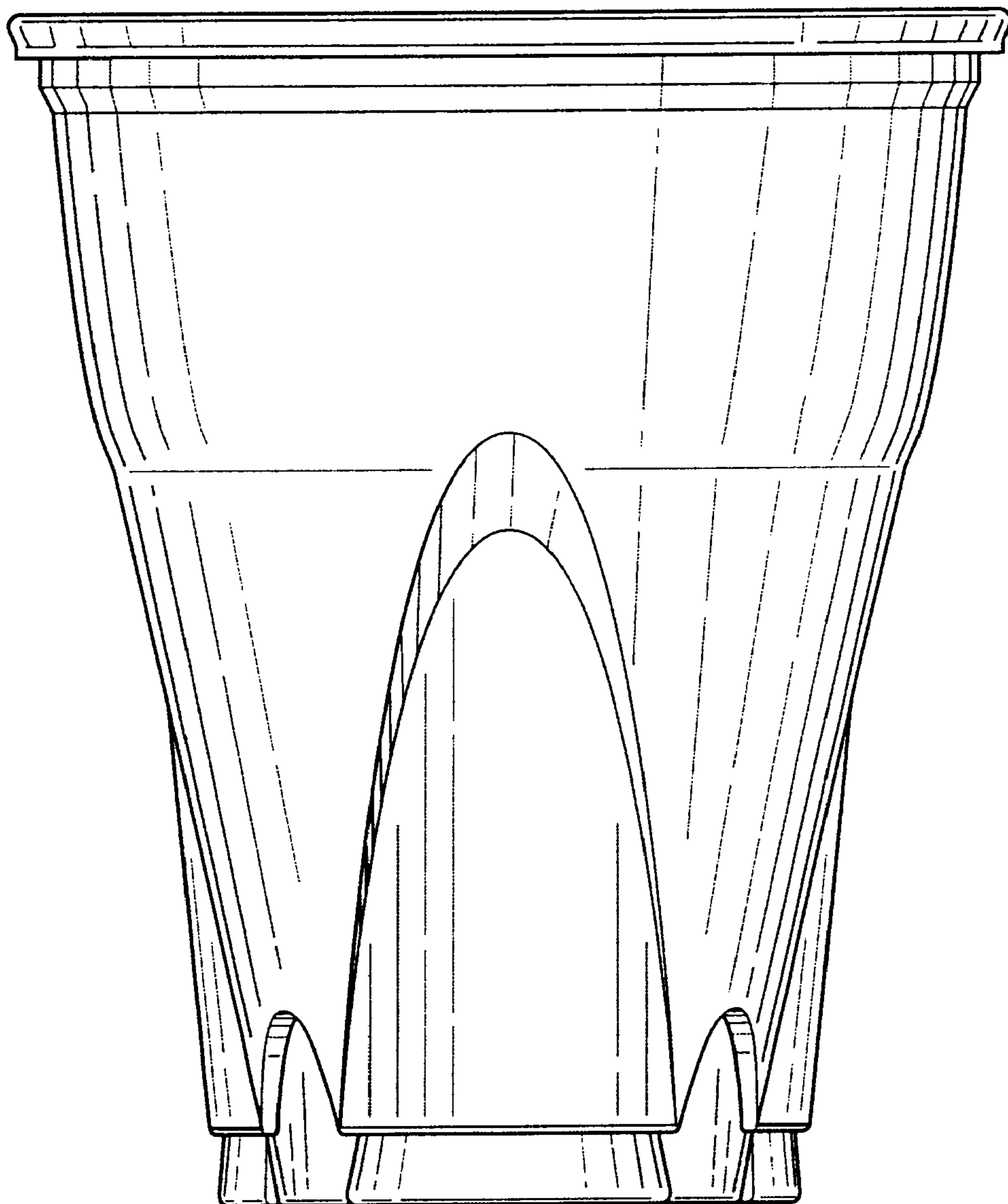

FIG. 7

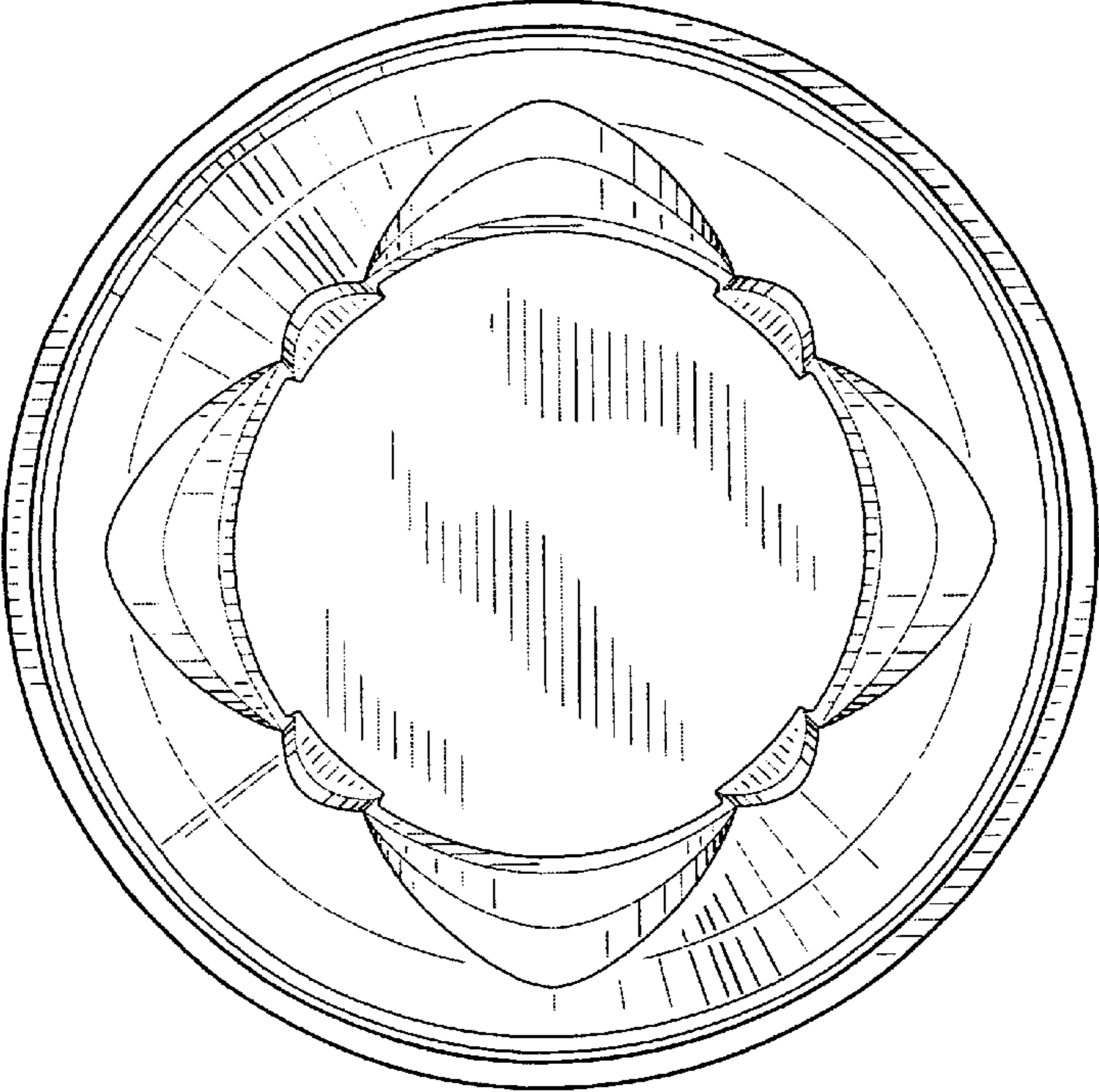

FIG. 8

