



US00D515349S

(12) **United States Design Patent**  
**Gillisie**

(10) **Patent No.:** **US D515,349 S**  
(45) **Date of Patent:** **\*\* Feb. 21, 2006**

- (54) **STEAM KETTLE**
- (75) **Inventor:** **Nicholas Brian Gillisie**, Toronto (CA)
- (73) **Assignee:** **Umbra, Inc.**, Buffalo, NY (US)
- (\*\*) **Term:** **14 Years**
- (21) **Appl. No.:** **29/220,420**
- (22) **Filed:** **Dec. 30, 2004**
- (51) **LOC (8) Cl.** ..... **07-01**
- (52) **U.S. Cl.** ..... **D7/319; D7/317; D7/536; D7/322**
- (58) **Field of Classification Search** ..... **D7/507, D7/523, 533, 536, 316-319, 320, 321, 300, D7/700, 600, 598, 622, 322; D9/527; D10/46.2, D10/46.3; 428/35.8; 141/331, 335; 215/12.2, 215/398, 6, 396; 222/188, 465.1, 144.5, 475.1; 220/23.4, 374, 713; 116/67 R, 137 R, 70; 206/423, 217; 99/299, 306, 322, 279**  
See application file for complete search history.

- 5,217,141 A \* 6/1993 Ross ..... 220/713
- 5,353,926 A \* 10/1994 Yeh ..... 206/217
- D376,073 S \* 12/1996 Griffin et al. .... D7/622
- D378,264 S \* 3/1997 Lage et al. .... D7/536
- D379,898 S 6/1997 Ancona et al.
- D417,814 S 12/1999 Huang
- D420,870 S \* 2/2000 DeCoster ..... D7/700
- 6,035,907 A \* 3/2000 DeCoster ..... 141/331
- D444,337 S 7/2001 Ryan et al.
- D452,408 S \* 12/2001 Liu ..... D7/319
- D461,683 S \* 8/2002 Bodum ..... D7/507
- 2003/0052139 A1 3/2003 Boyte et al.

\* cited by examiner

*Primary Examiner*—M. N. Pandozzi  
(74) *Attorney, Agent, or Firm*—Simpson & Simpson, PLLC

(57) **CLAIM**

The ornamental design for a steam kettle, as shown and described.

**DESCRIPTION**

FIG. 1 is a perspective view of the steam kettle of the invention;  
 FIG. 2 is a side elevational view of the steam kettle with handle on the right;  
 FIG. 3 is a side elevational view of the steam kettle with handle on the left;  
 FIG. 4 is a top plan view of the steam kettle of the invention;  
 FIG. 5 is a bottom plan view of the steam kettle with centrally positioned generally triangularly shaped indentation;  
 FIG. 6 is a front elevational view of the steam kettle;  
 FIG. 7 is a back elevational view of the steam kettle;  
 FIG. 8 is a perspective view of the steam kettle having the top closure in an open position for filling; and,  
 FIG. 9 is a perspective view of the steam kettle having the top closure in an open position for dispensing.

**1 Claim, 5 Drawing Sheets**

(56) **References Cited**

**U.S. PATENT DOCUMENTS**

- 1,657,664 A 1/1928 Dexter
- D113,154 S \* 1/1939 Wellman ..... D7/523
- D177,378 S 4/1956 Hvale
- D178,610 S 8/1956 McIntosh
- D179,135 S 11/1956 Graham
- 2,835,188 A 5/1958 Graham
- D205,781 S 9/1966 Valle et al.
- D224,034 S \* 6/1972 Douglas ..... D7/318
- D229,917 S 1/1974 Swett
- D259,613 S 6/1981 Sun
- D277,535 S \* 2/1985 Langer et al. .... D7/536
- 4,651,900 A 3/1987 Horvath et al.
- 4,813,368 A 3/1989 Hutter, III et al.
- 4,858,787 A 8/1989 Stone
- 5,215,794 A 6/1993 Johnson

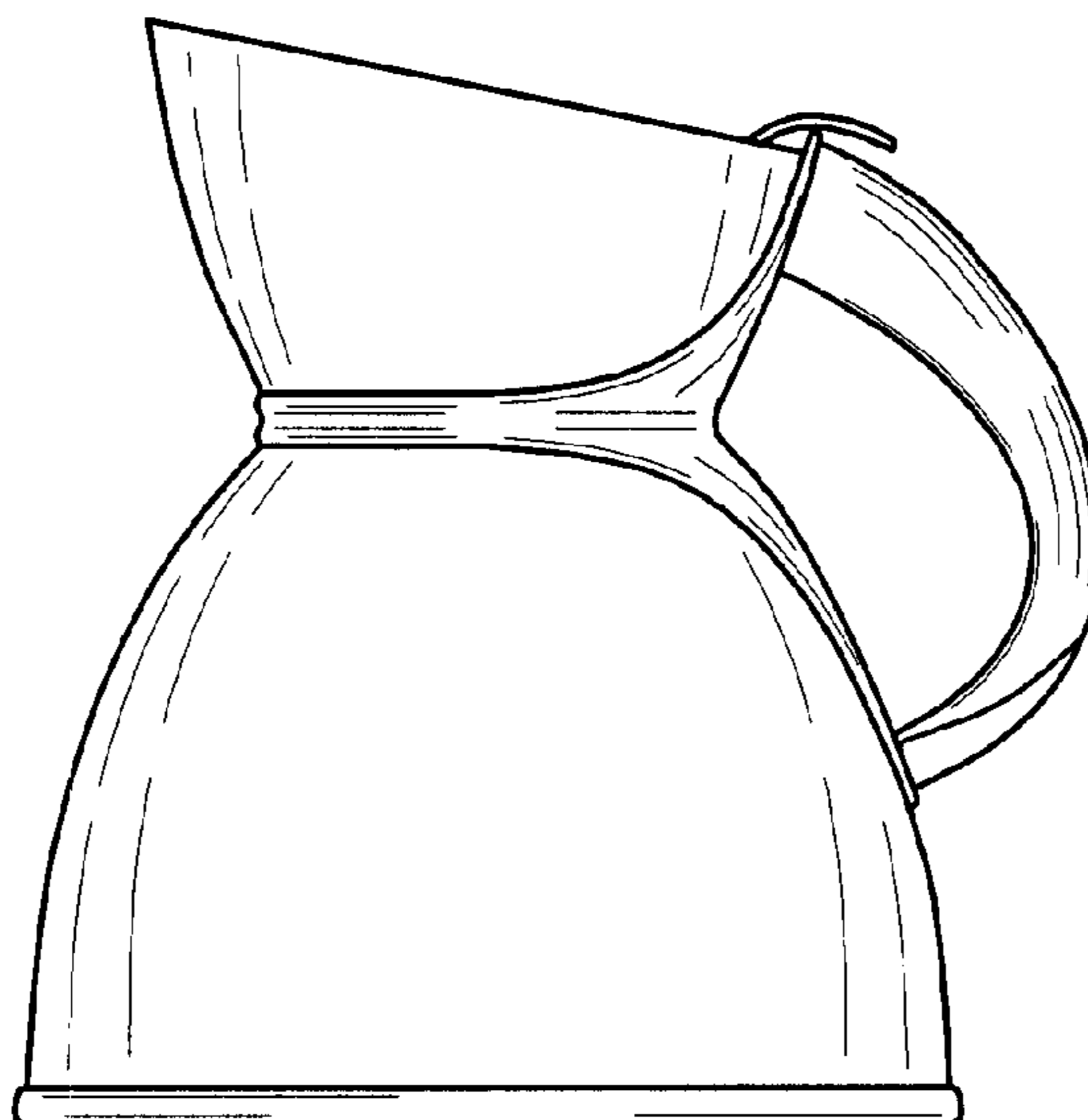



FIG. 1

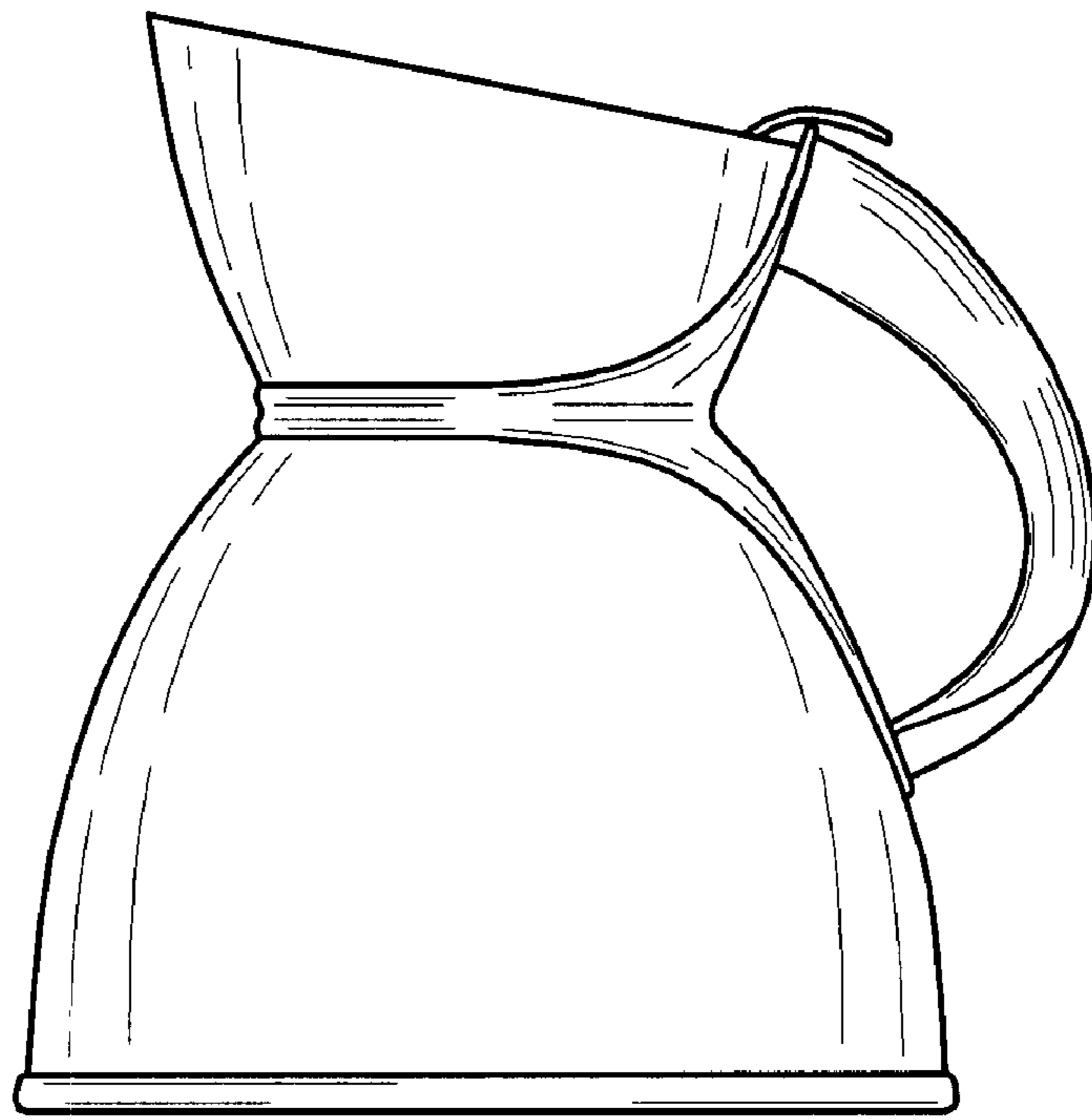

FIG. 2

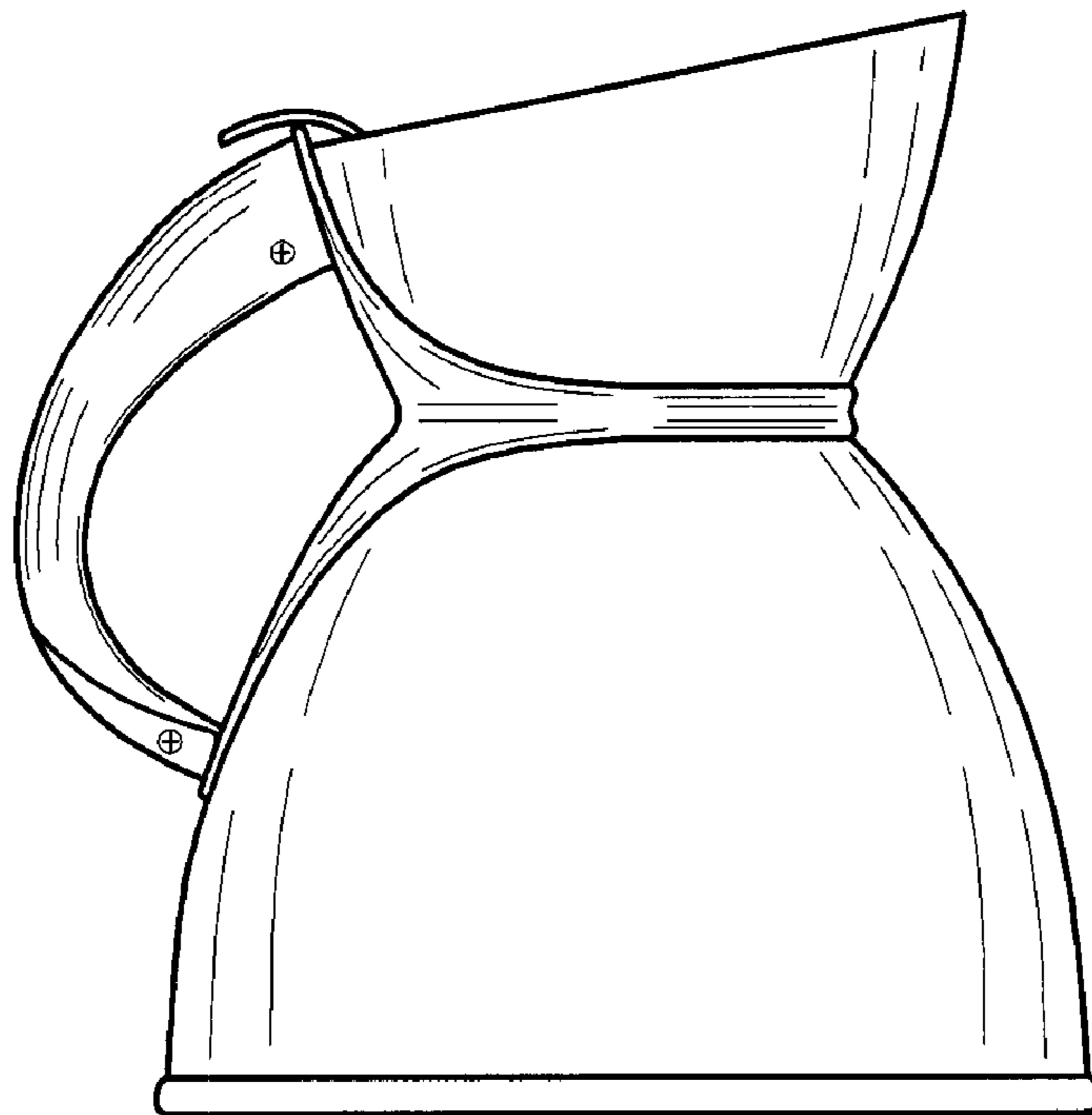

FIG. 3

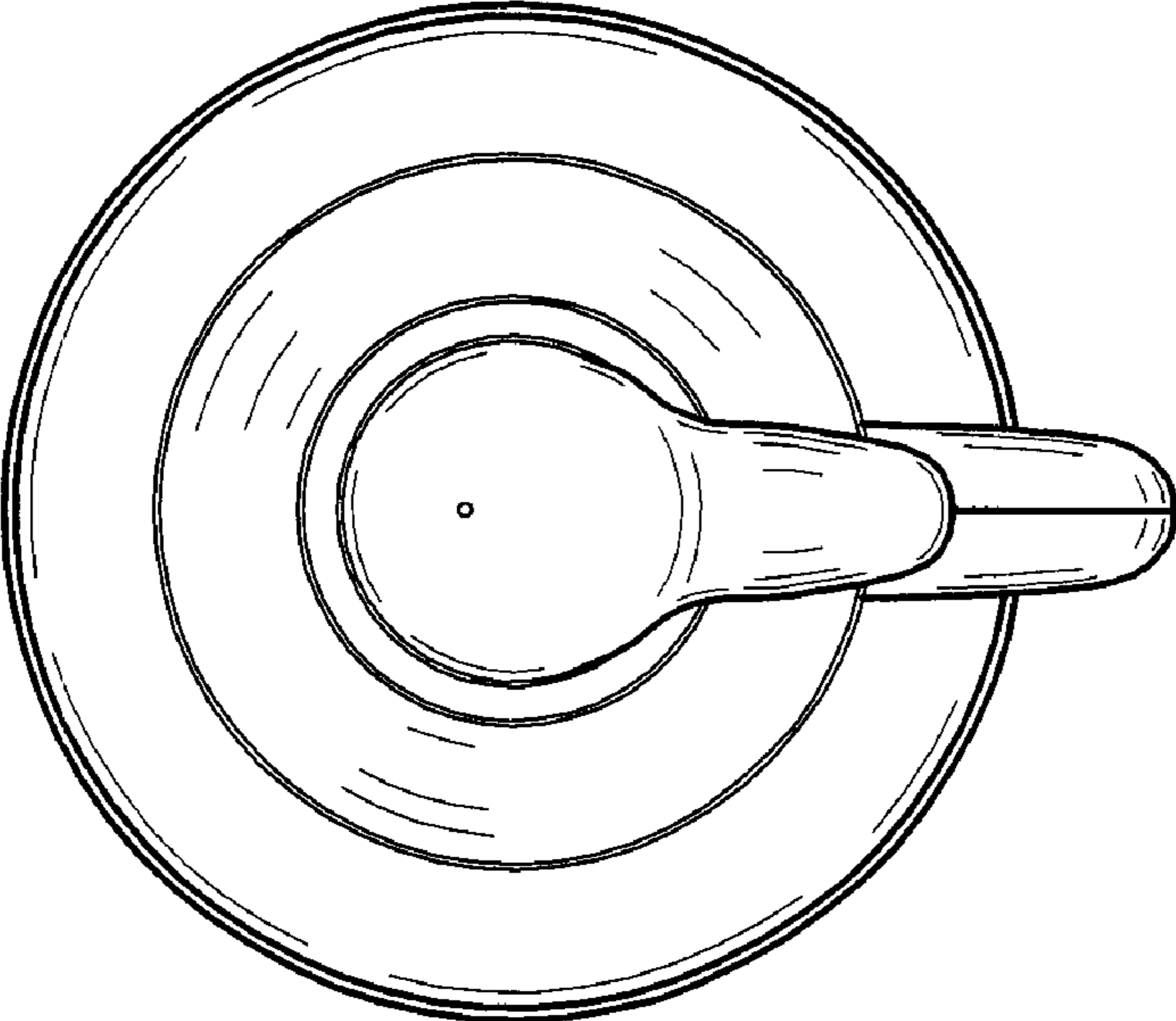

FIG. 4

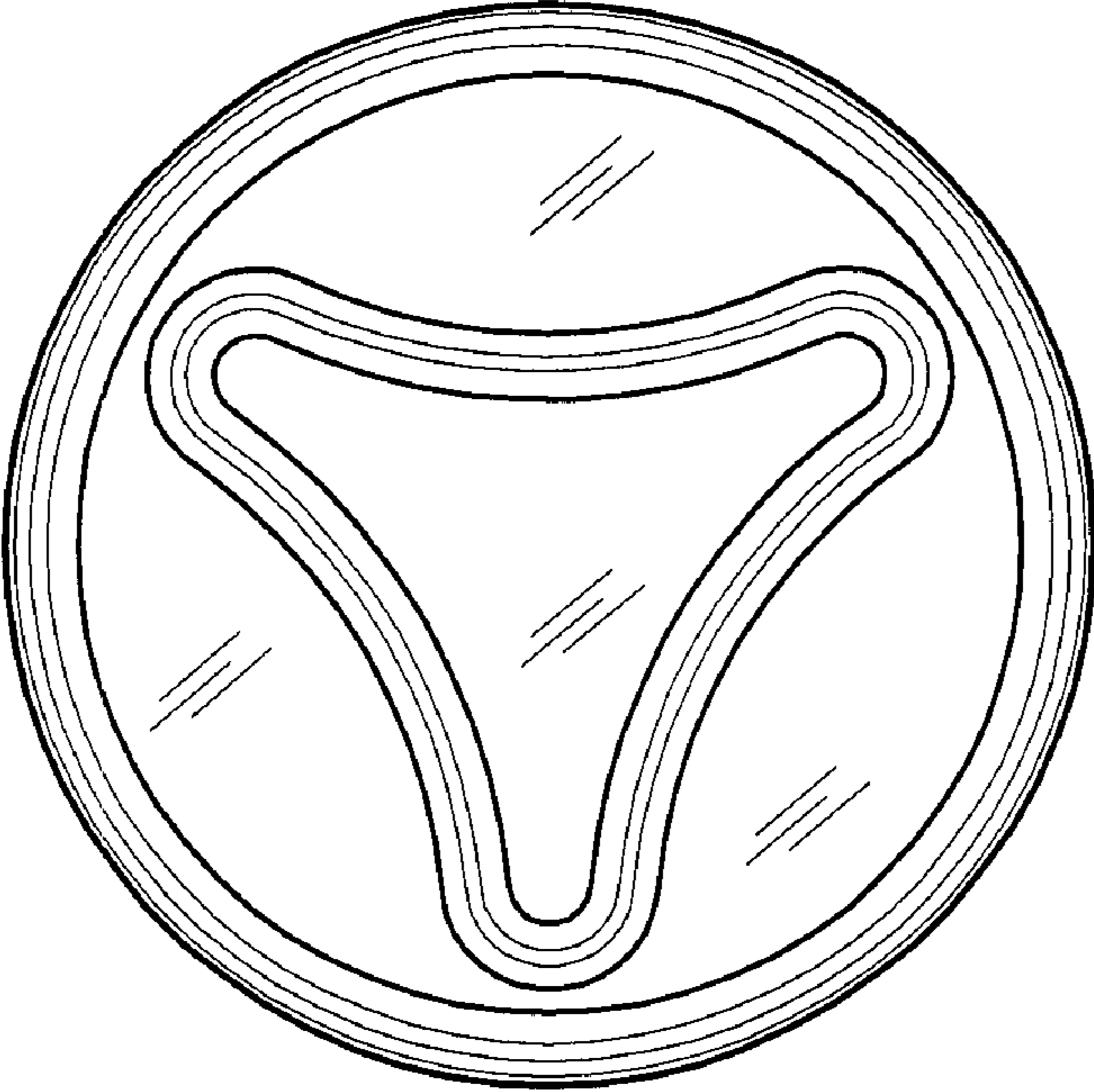

FIG. 5

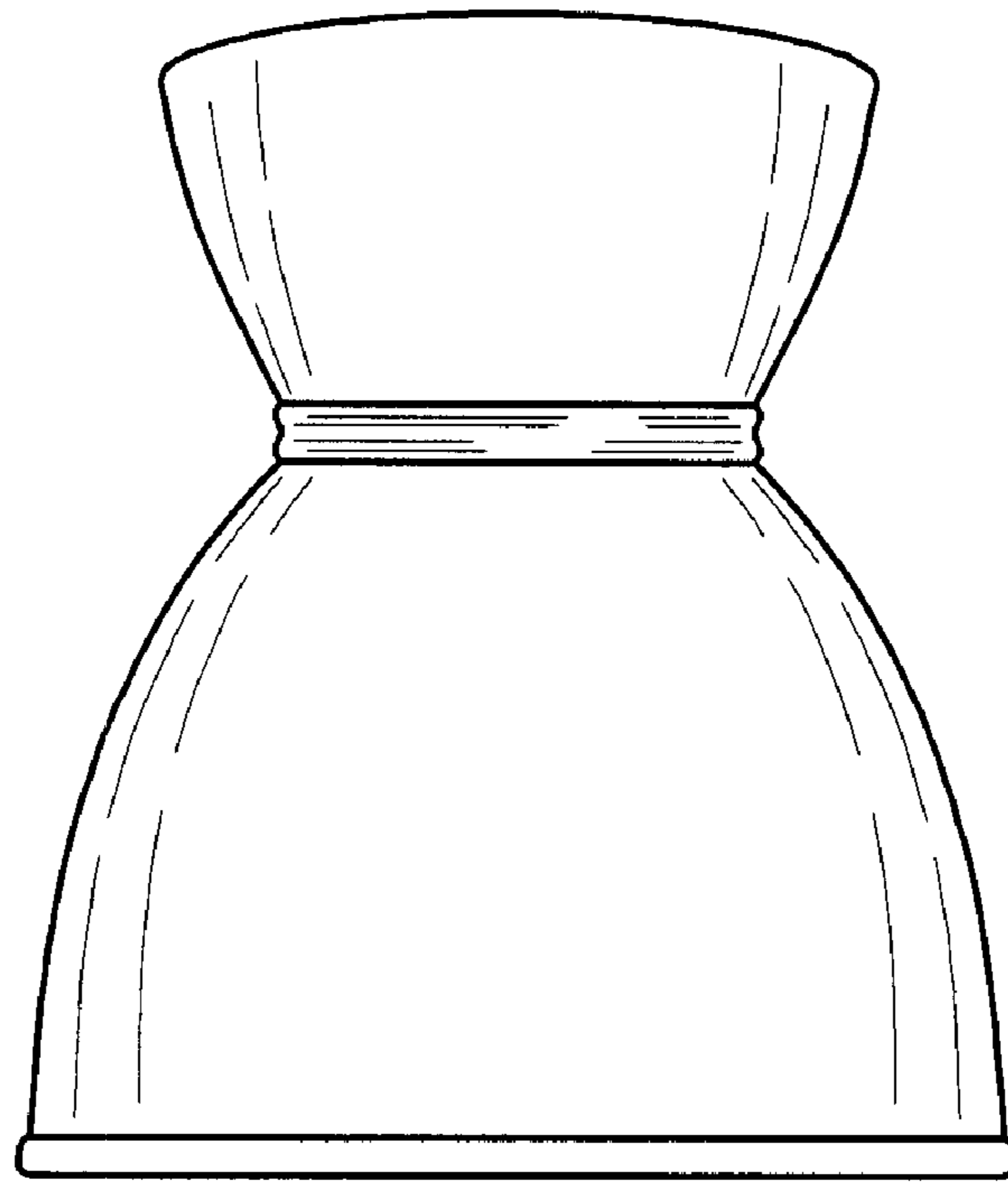

FIG. 6

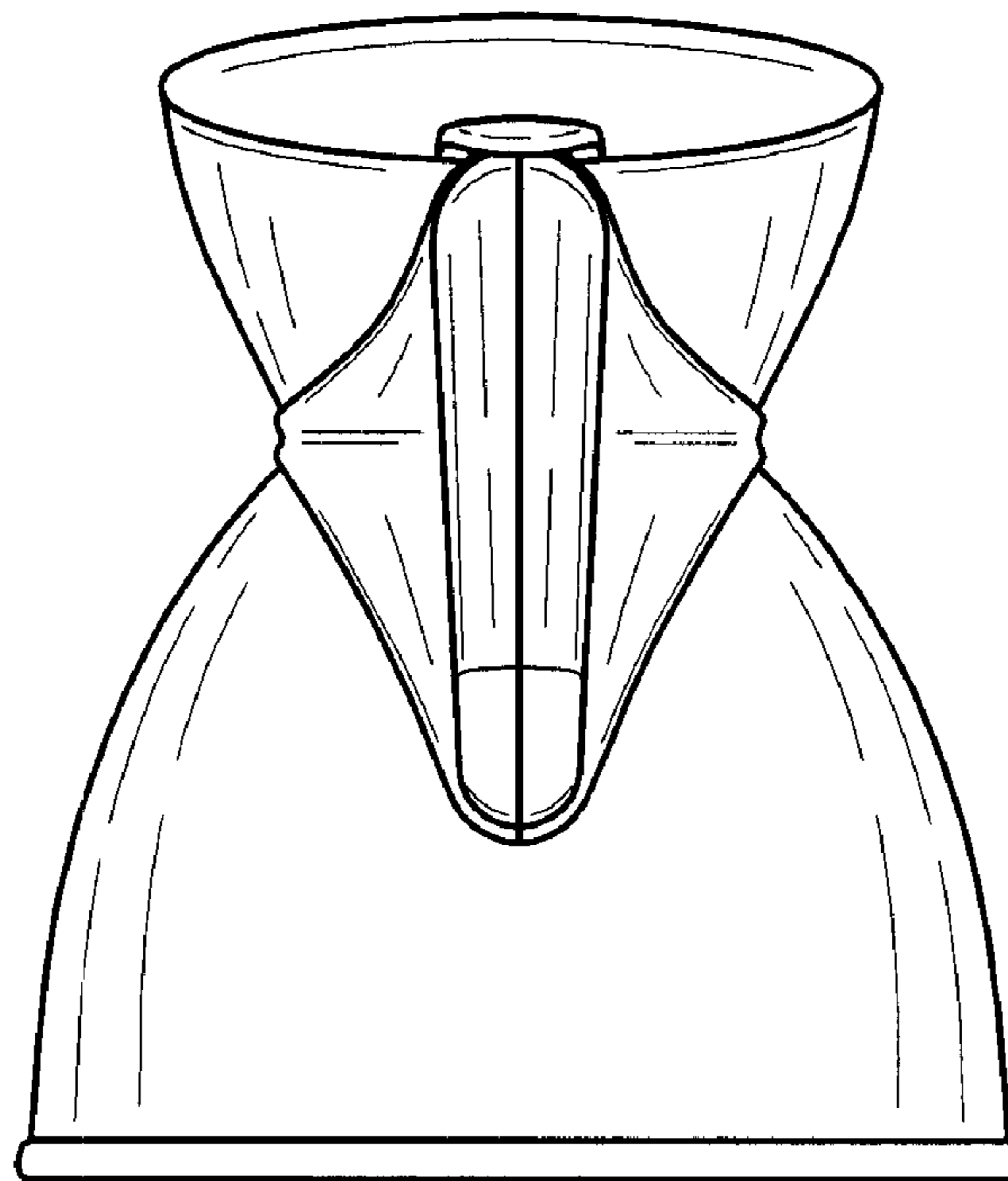

FIG. 7

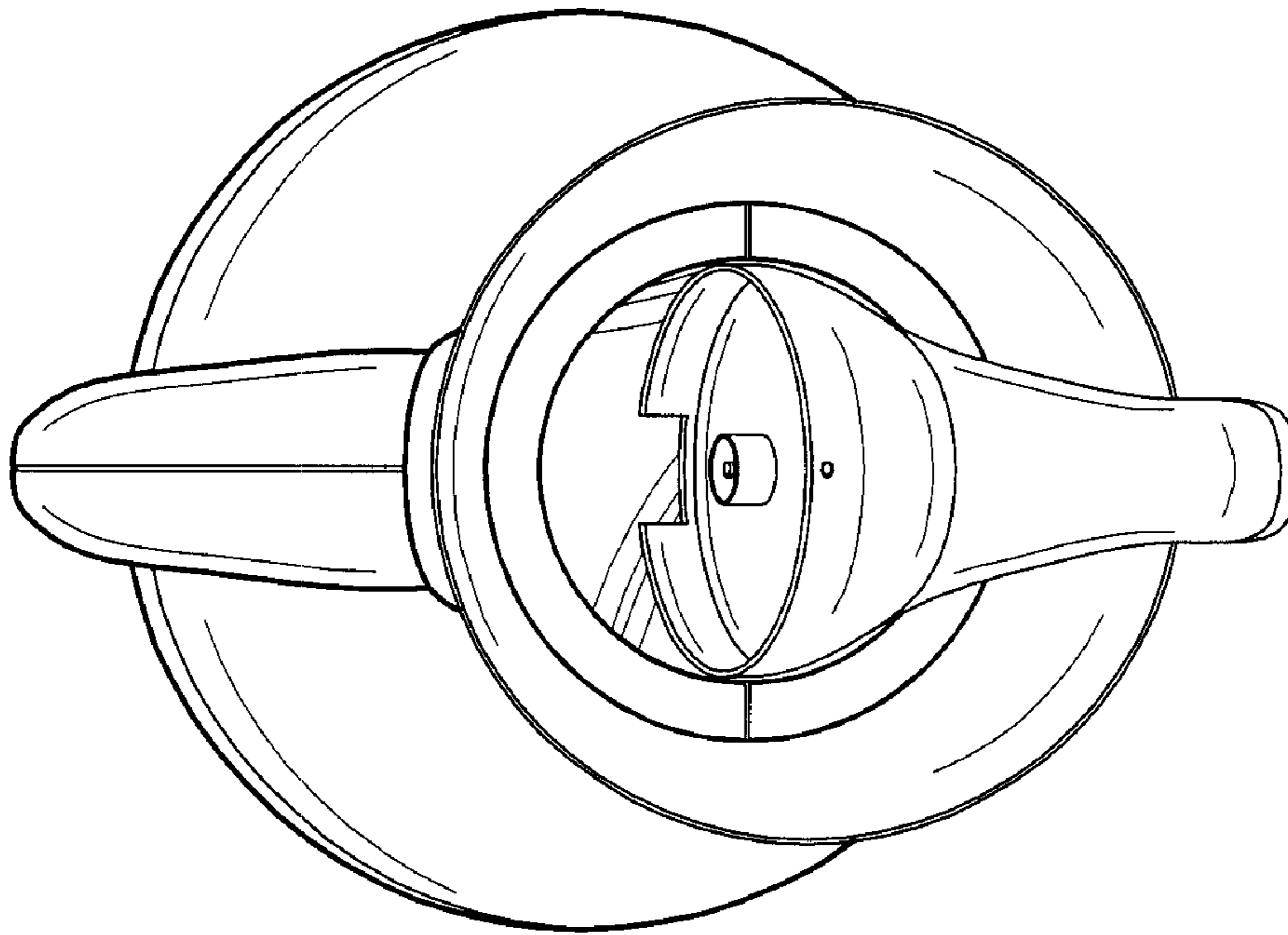

FIG. 8

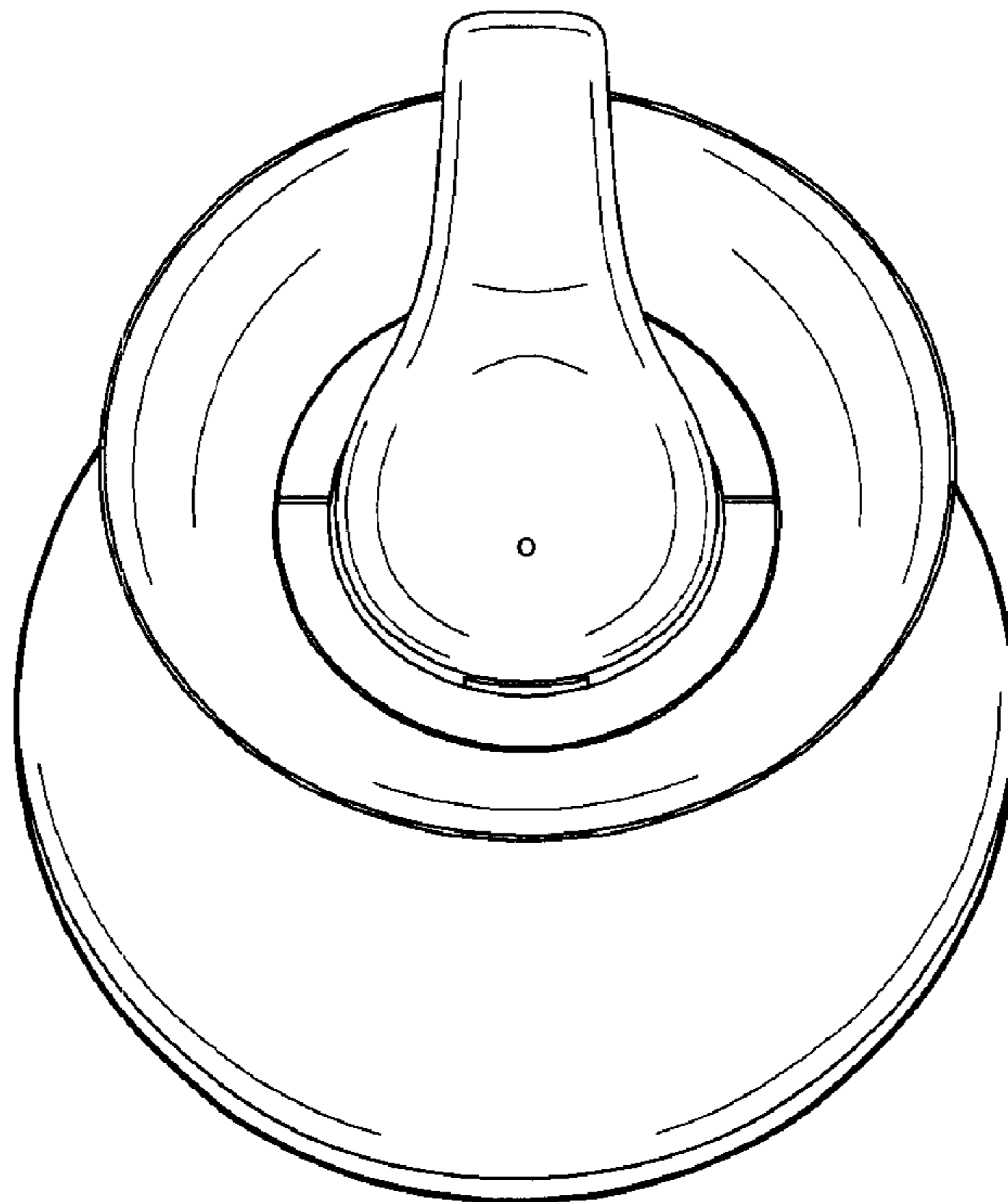

FIG. 9

UNITED STATES PATENT AND TRADEMARK OFFICE  
**CERTIFICATE OF CORRECTION**

PATENT NO. : Des. 515,349 S  
DATED : February 21, 2006  
INVENTOR(S) : Nicholas Brian Gillisie

Page 1 of 1

It is certified that error appears in the above-identified patent and that said Letters Patent is hereby corrected as shown below:

Title page,  
Item [57], **CLAIM,**  
Line 1, insert -- I claim -- at the beginning.

Signed and Sealed this

Sixteenth Day of May, 2006

A handwritten signature in black ink on a dotted background. The signature reads "Jon W. Dudas" in a cursive style.

JON W. DUDAS

*Director of the United States Patent and Trademark Office*