



US00D515300S

(12) **United States Design Patent**
White et al.

(10) **Patent No.:** **US D515,300 S**
(45) **Date of Patent:** **** Feb. 21, 2006**

(54) **FOOTWEAR UPPER**

D499,244 S * 12/2004 Dombrow D2/972

(75) Inventors: **Ian M. White**, Rockford, MI (US);
Andris Kalns, Helotes, TX (US)

(73) Assignee: **Wolverine World Wide, Inc.**,
Rockford, MI (US)

(**) Term: **14 Years**

(21) Appl. No.: **29/208,909**

(22) Filed: **Jul. 7, 2004**

(51) **LOC (8) Cl.** **02-99**

(52) **U.S. Cl.** **D2/972**

(58) **Field of Classification Search** D2/902,
D2/907, 908, 943, 944, 969, 972-974, 909-912,
D2/970; 36/45, 50.1, 77 M, 77 R, 83, 88,
36/113, 114, 126-131

See application file for complete search history.

(56) **References Cited**

U.S. PATENT DOCUMENTS

D242,089 S	*	11/1976	Raufast	D2/911
D346,479 S	*	5/1994	Teague	D2/970
D385,102 S	*	10/1997	Avar	D2/972
D399,039 S	*	10/1998	Toschi	D2/911
D438,698 S	*	3/2001	Matis et al.	D2/970
D440,387 S	*	4/2001	Matis et al.	D2/970
D480,549 S	*	10/2003	Matis et al.	D2/969
D492,097 S	*	6/2004	Magro	D2/902
D495,862 S	*	9/2004	Riosa	D2/969
D499,233 S	*	12/2004	Sedlbauer	D2/910

OTHER PUBLICATIONS

Hy-Test Catalog 1998, pp 16, 38, 40.
Wolverine Catalog 1997, p 26.

* cited by examiner

Primary Examiner—Dominic Simone

(74) *Attorney, Agent, or Firm*—Warner Norcross & Judd
LLP

(57) **CLAIM**

The ornamental design for footwear upper, as shown and
described.

DESCRIPTION

FIG. 1 is a perspective view of the footwear upper embody-
ing the new design;
FIG. 2 is a top plan view thereof;
FIG. 3 is a right side elevational view thereof;
FIG. 4 is a left side elevational view thereof;
FIG. 5 is a front elevational view thereof; and,
FIG. 6 is a rear elevational view thereof.

FIGS. 1-6 show features of the footwear in phantom lines.
These features are shown for environmental purposes, and
do not form any part of the claimed design. The phantom
lines around the perimeter, and immediately adjacent to the
solid-line portion of the design forms the boundary of the
design, with the phantom lines forming no part of the
claimed design.

1 Claim, 4 Drawing Sheets

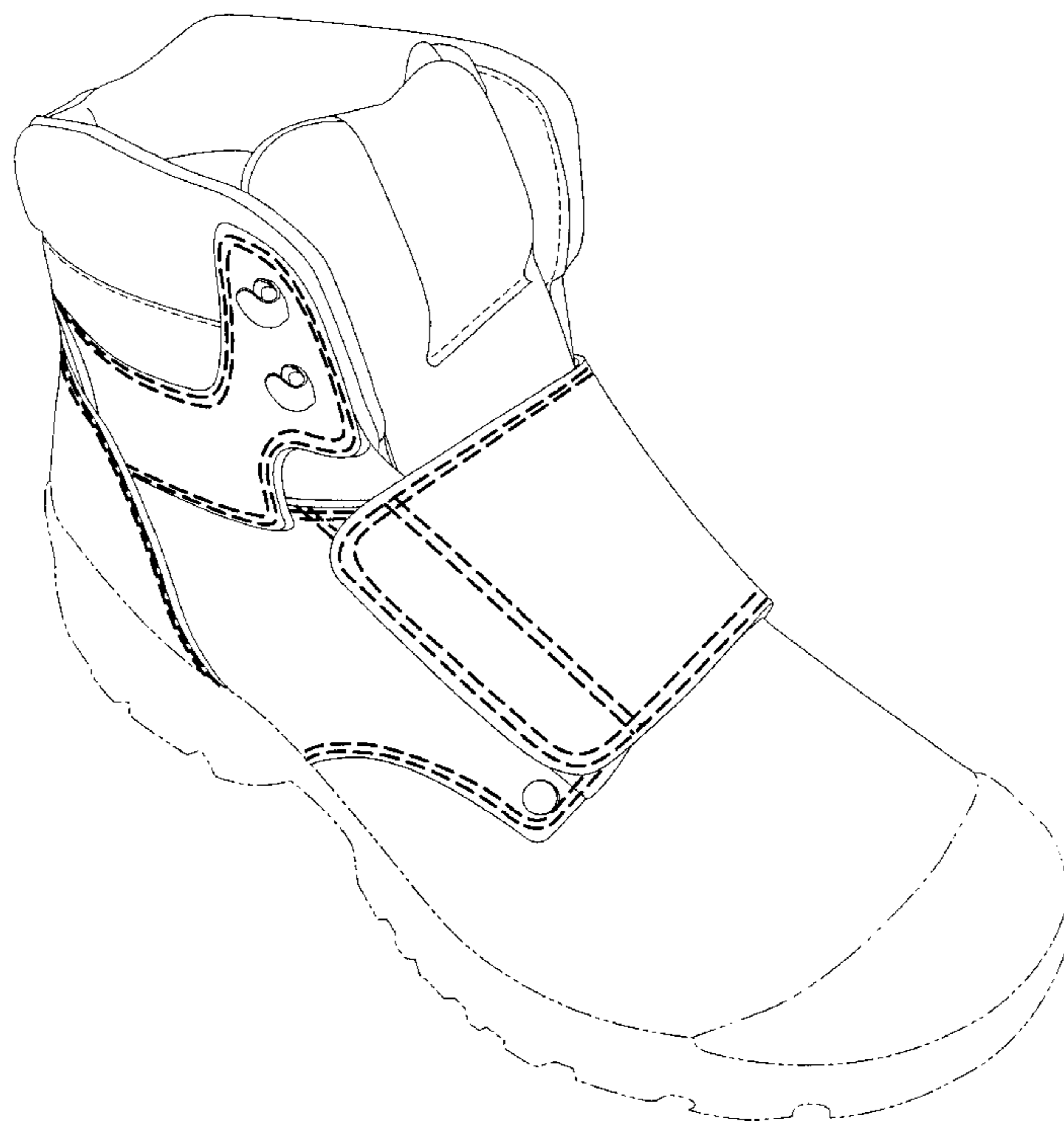

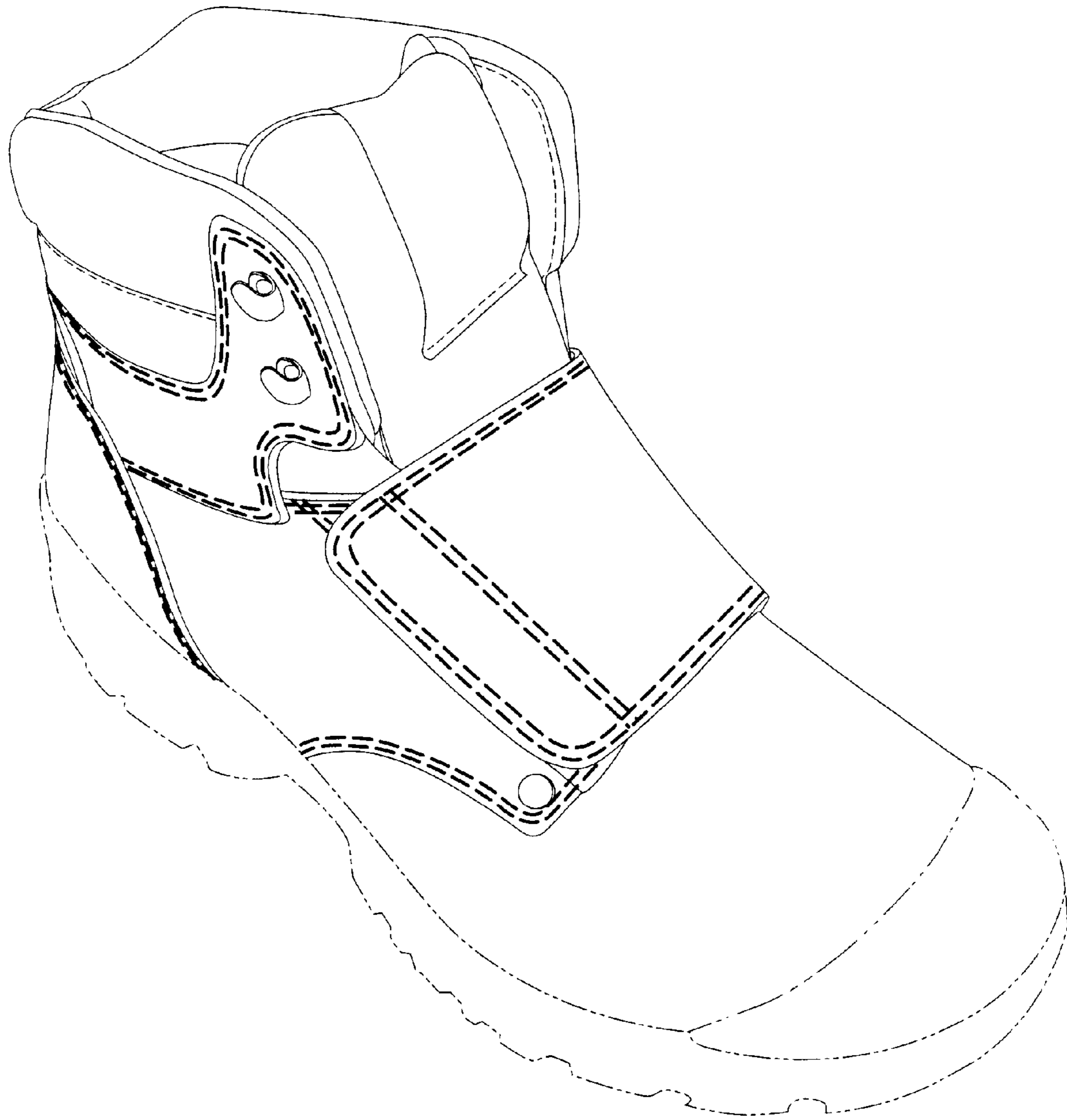

Fig. 1

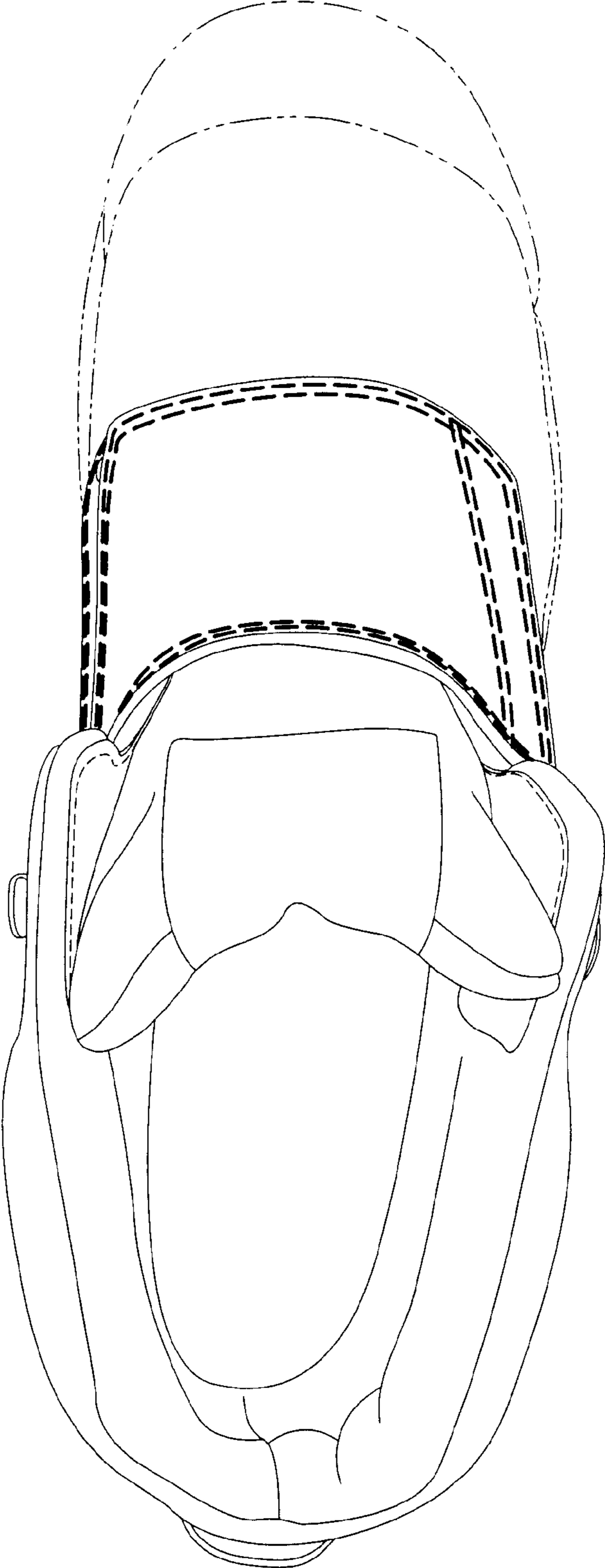

Fig. 2

Fig. 3

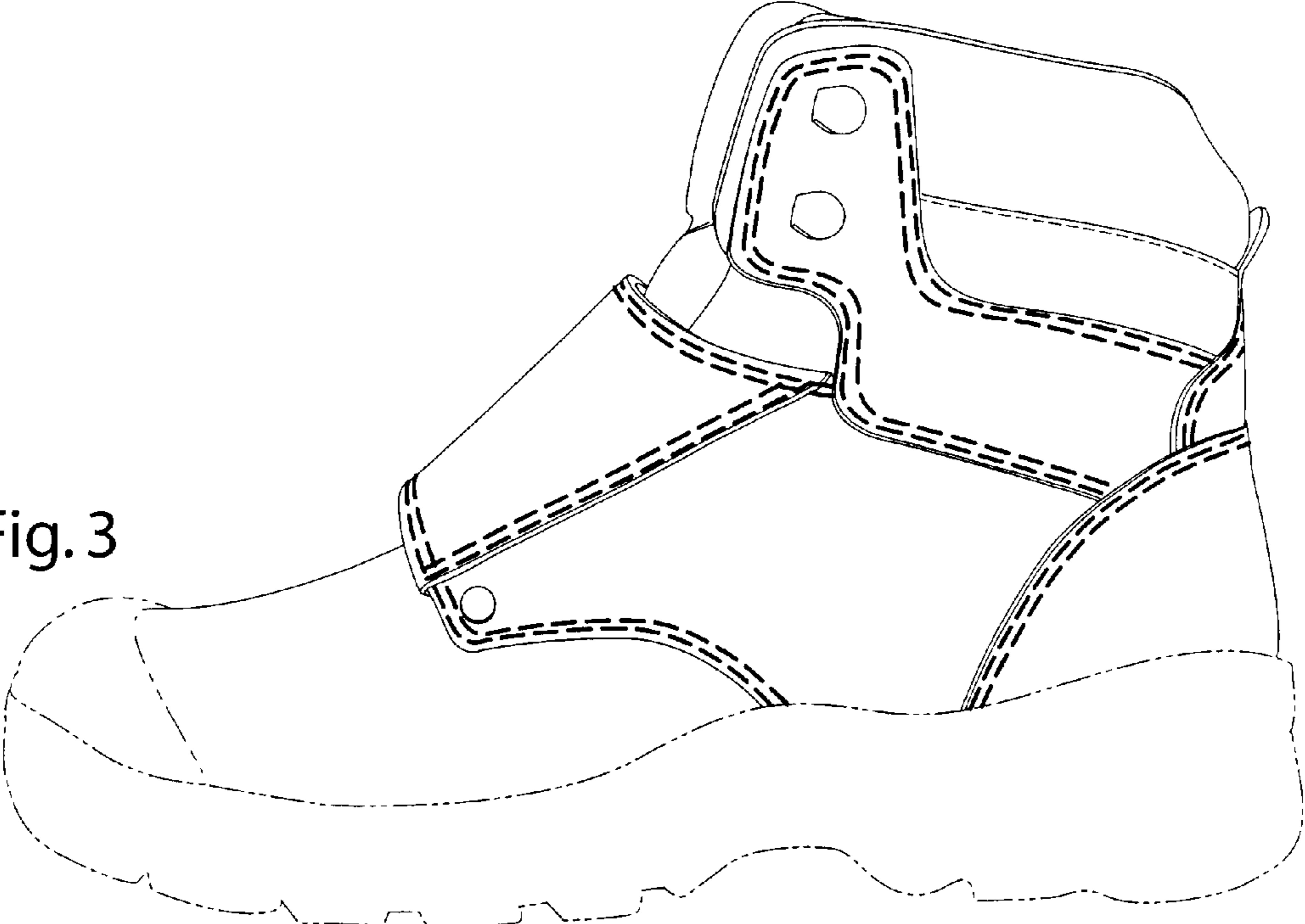
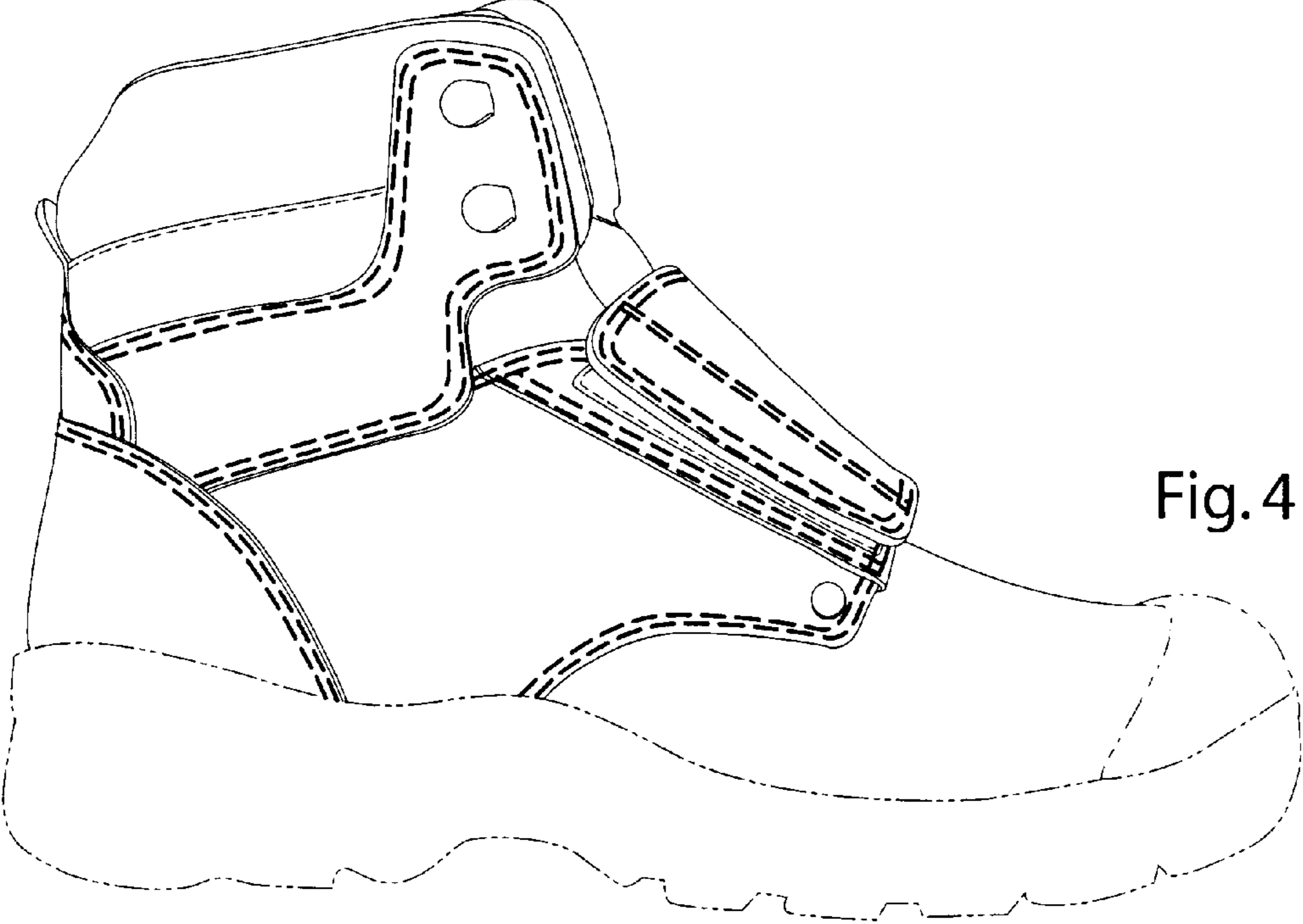

Fig. 4



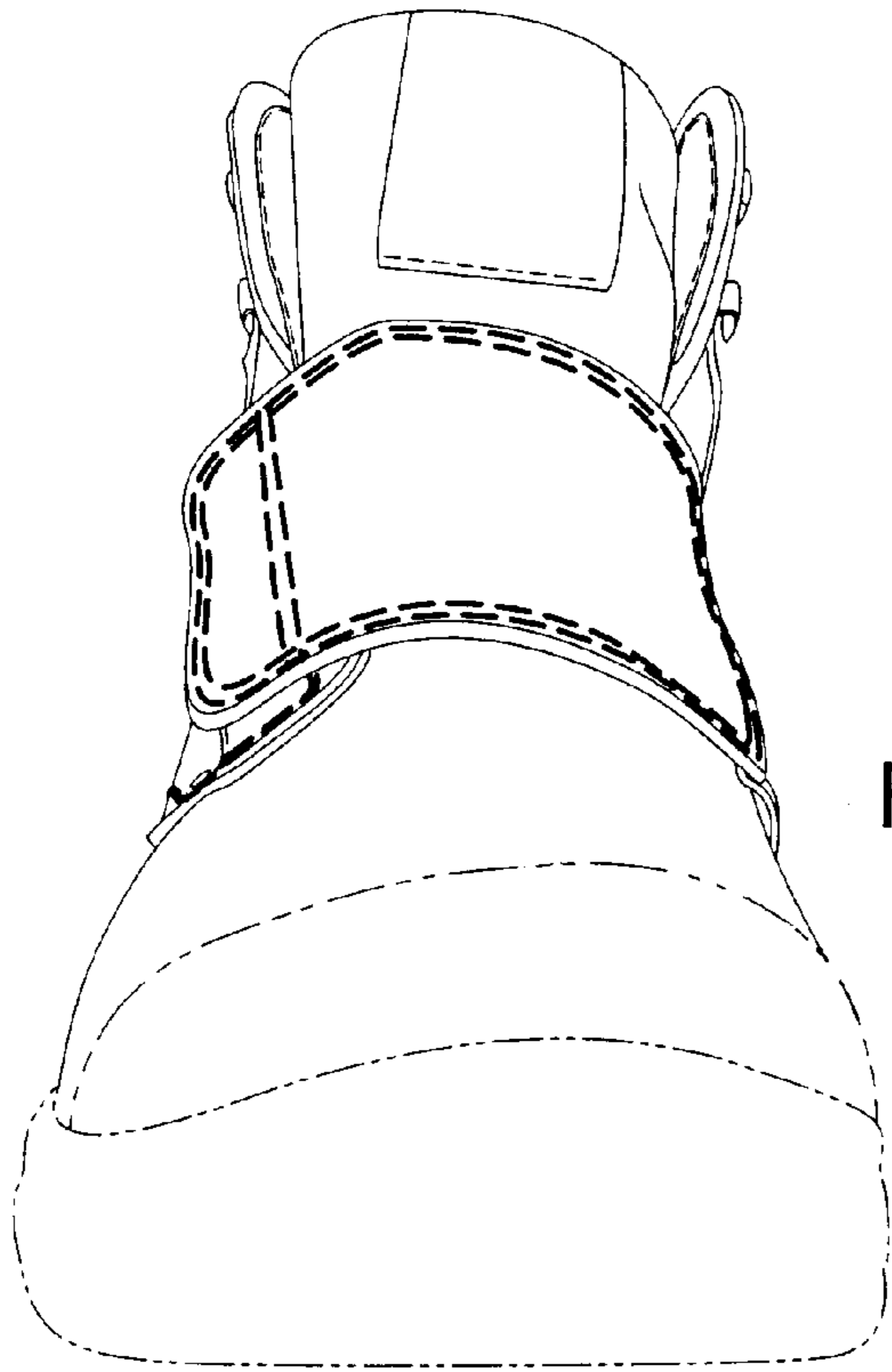

Fig. 5

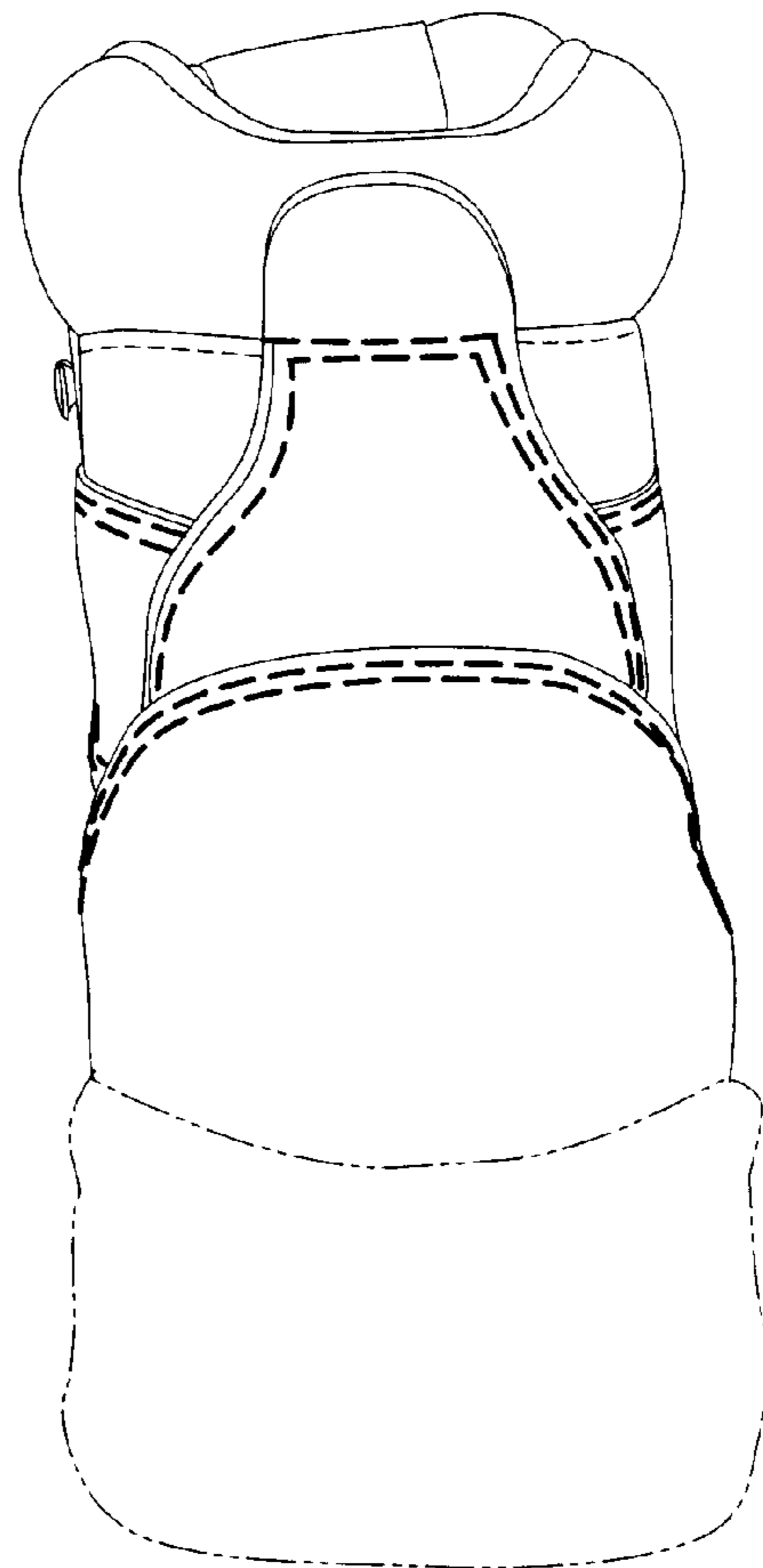

Fig. 6