



US00D515261S

(12) **United States Design Patent**
Henson

(10) **Patent No.:** **US D515,261 S**

(45) **Date of Patent:** **** Feb. 14, 2006**

(54) **HAND-HELD POOL SKIMMER WITH EXTENSIBLE HANDLE**

(76) Inventor: **Marlene E. Henson**, 18202 S. 33rd Pl., Phoenix, AZ (US) 85043

(**) Term: **14 Years**

(21) Appl. No.: **29/192,037**

(22) Filed: **Oct. 15, 2003**

(51) **LOC (8) Cl.** **08-99**

(52) **U.S. Cl.** **D32/35; D7/667; D22/135**

(58) **Field of Classification Search** D7/667, D7/668, 691; D22/135; D30/162; D32/35; 15/1.7; 43/7, 8, 11, 12; 210/470, 473, 474, 210/169, 471, 495, 497.3, 499, 776; 248/94; 294/1.3, 1.5, 55

See application file for complete search history.

(56) **References Cited**

U.S. PATENT DOCUMENTS

2,706,664 A * 4/1955 Conrad 43/12 X
D316,619 S * 4/1991 Richarson et al. D32/35
D381,781 S * 7/1997 Clay D32/35
D460,625 S * 7/2002 Wright D32/35

FOREIGN PATENT DOCUMENTS

CA 2115480 A * 8/1995
JP 10084815 A * 4/1998
JP 2001078622 A * 3/2001
JP 2003144008 A * 5/2003

* cited by examiner

Primary Examiner—Alan P. Douglas

Assistant Examiner—Lavone D. Tabor

(74) *Attorney, Agent, or Firm*—Ethernon Law Group, LLC; Sandra Ethernon

(57) **CLAIM**

The ornamental design for a hand-held pool skimmer with extensible handle, as shown and described.

DESCRIPTION

The nature and intended use of the article in which the design is embodied is as a hand-held pool skimmer to remove unwanted floating or submerged items from a pool. Close items are reached with the handle in its normal, retracted position; more distant items are reached by extending the handle.

FIG. 1 is the front view of a hand-held pool skimmer showing the handle in its normal, retracted position.

FIG. 2 is an end view of the pool skimmer from the scoop end.

FIG. 3 is an end view of the pool skimmer from the handle end.

FIG. 4 is a right side view of a pool skimmer showing the handle in its normal, retracted position. The left side view is a mirror image thereof.

FIG. 5 is a rear view of a pool skimmer showing the handle in its normal, retracted position; and,

FIG. 6 is a perspective view of the pool skimmer showing the handle in its normal, retracted position.

The hatching partially shown in all of the views represents a conventional material and is understood to continue throughout the entire surface on which it is shown.

1 Claim, 5 Drawing Sheets

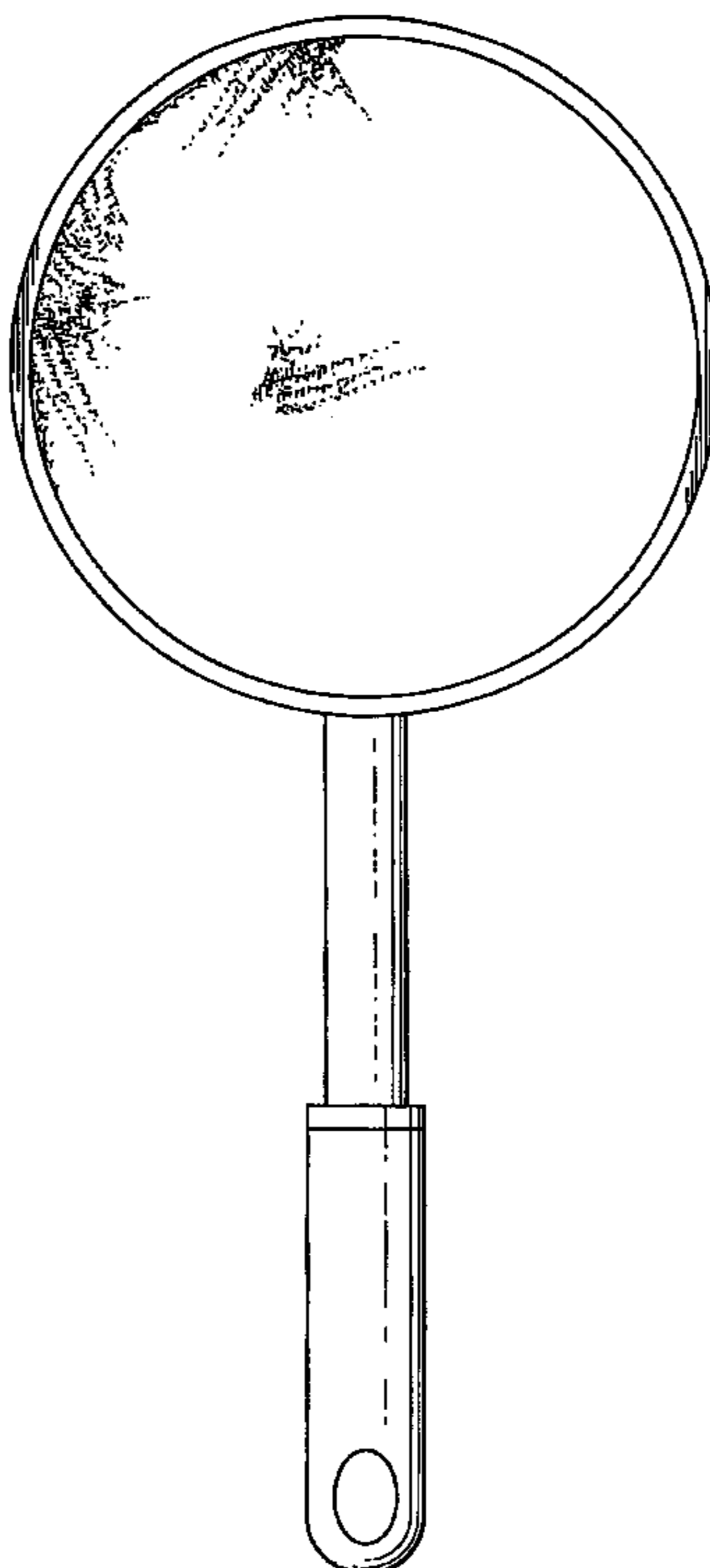

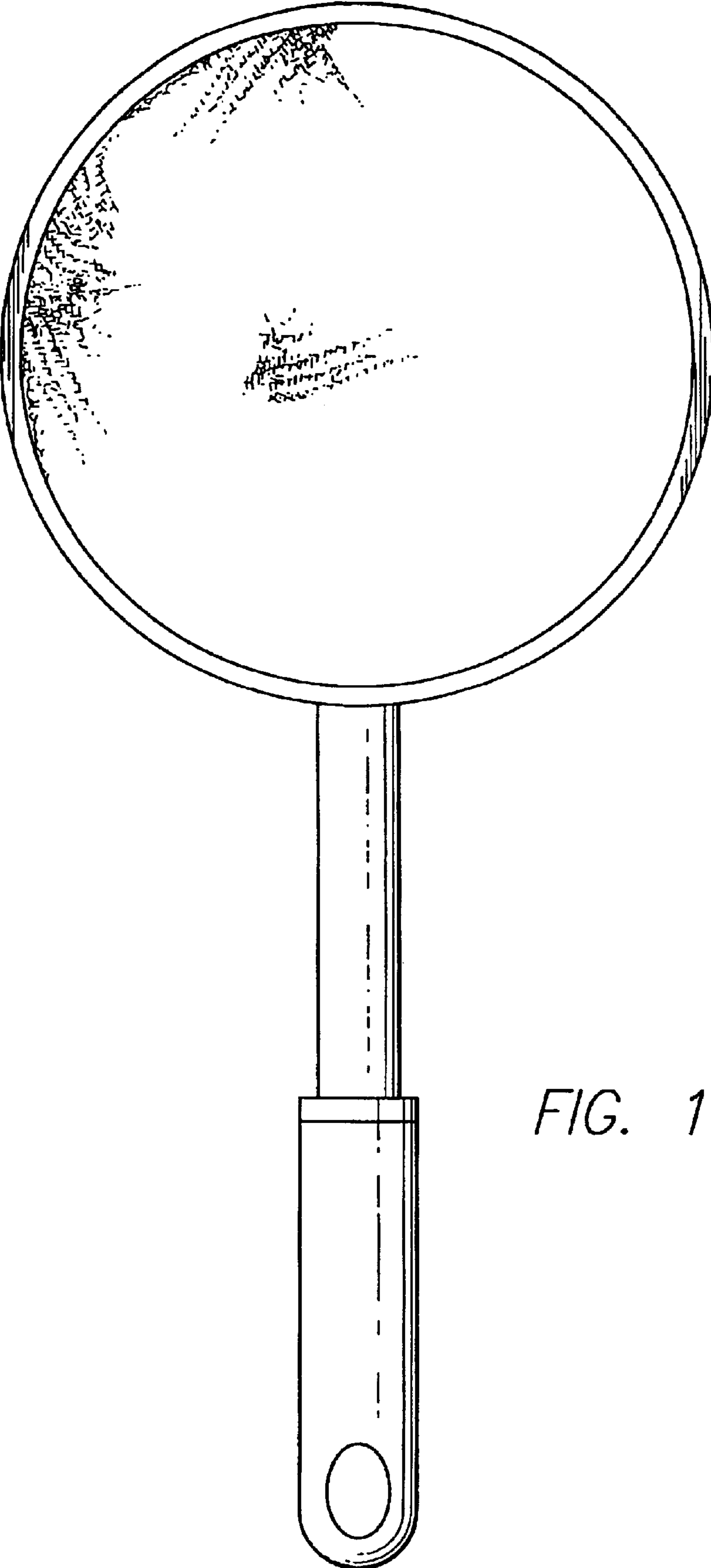

FIG. 1

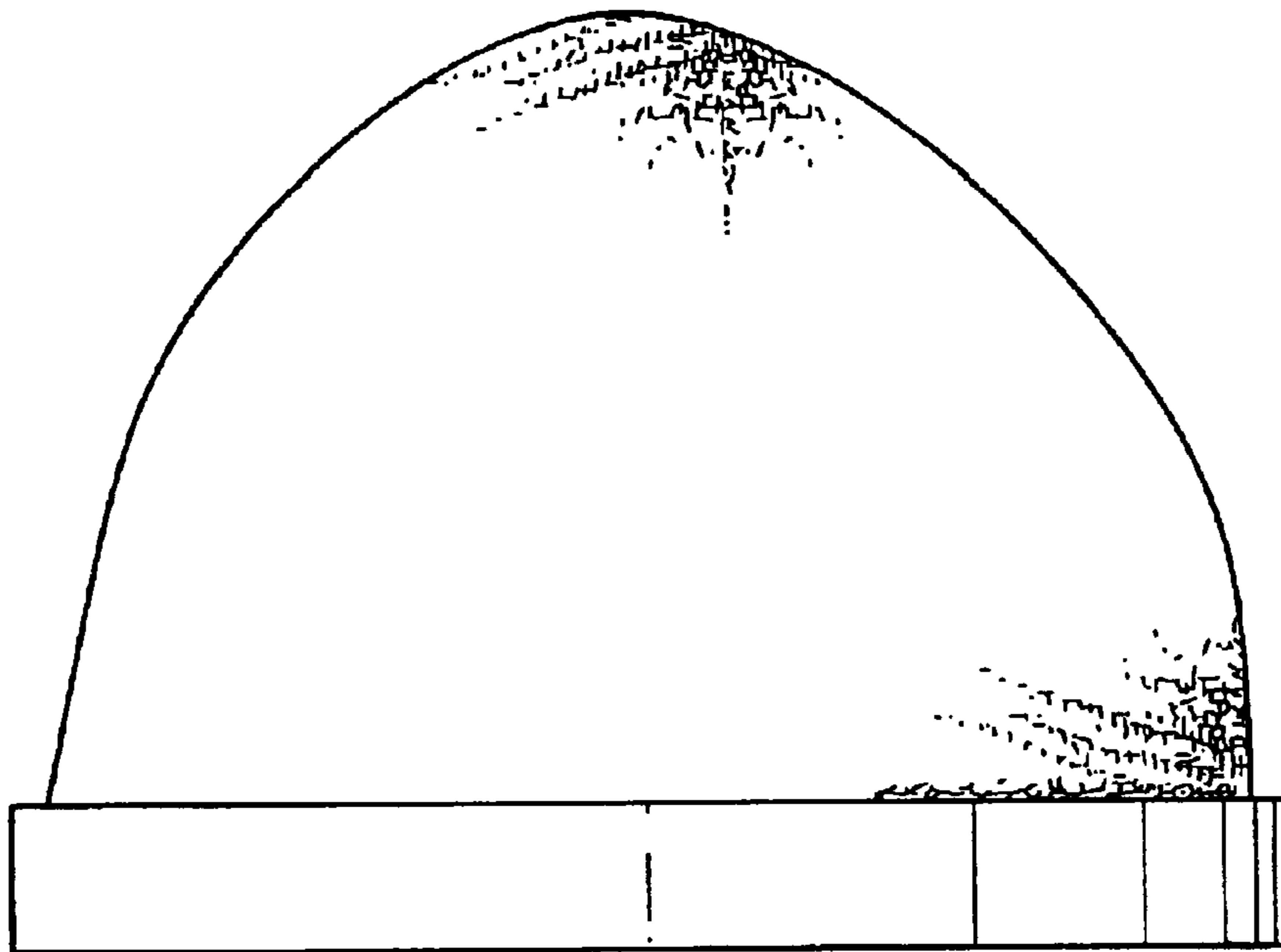
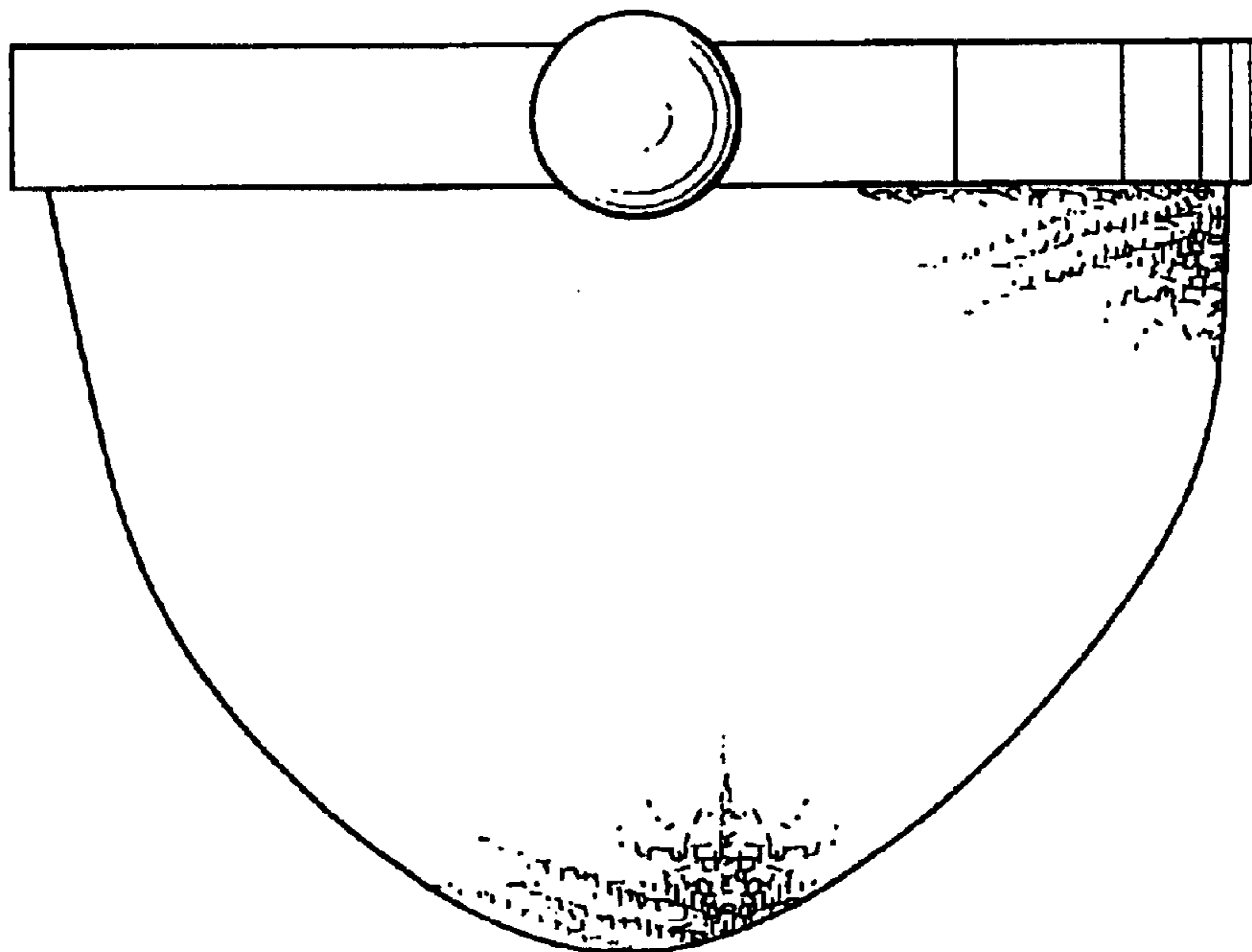

FIG. 2

FIG. 3



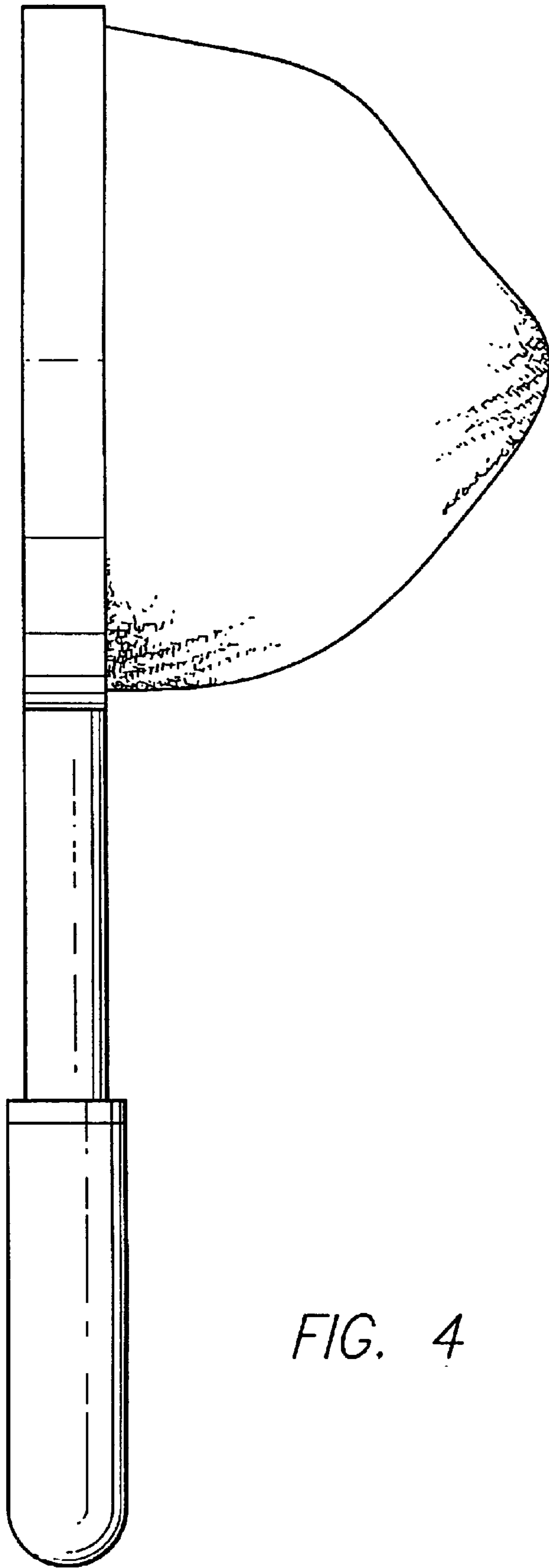

FIG. 4

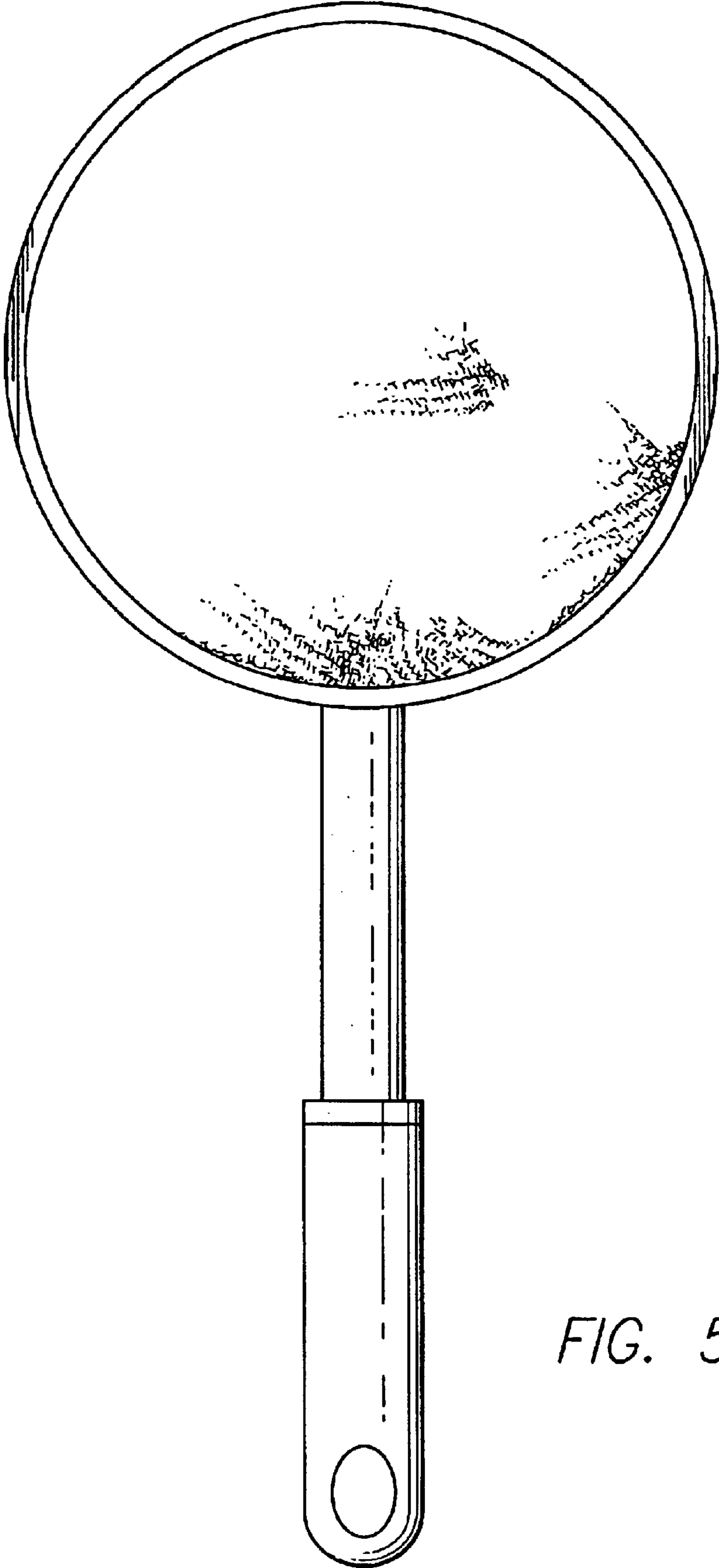

FIG. 5

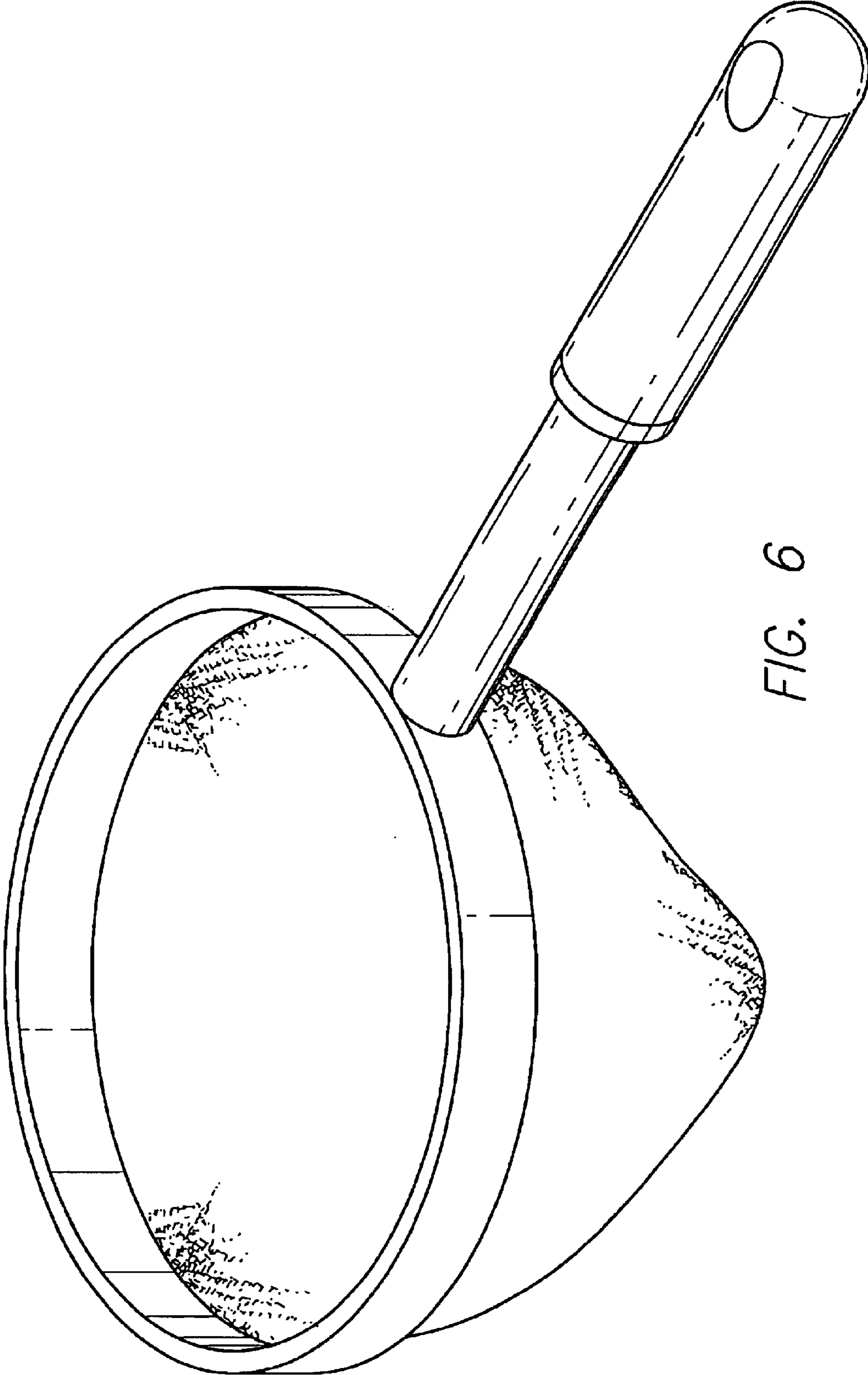

FIG. 6