



US00D515232S

(12) **United States Design Patent** (10) **Patent No.:** **US D515,232 S**
Aviles (45) **Date of Patent:** **** Feb. 14, 2006**

(54) **LAMP**

(76) Inventor: **Andres Aviles**, 230 Power Ct., Ste. 100, Sanford, FL (US) 32771

(**) Term: **14 Years**

(21) Appl. No.: **29/195,781**

(22) Filed: **Dec. 17, 2003**

(51) **LOC (8) Cl.** **26-03**

(52) **U.S. Cl.** **D26/87; D26/92**

(58) **Field of Classification Search** D26/72, D26/85-92, 128; 362/147, 432, 404-408

See application file for complete search history.

(56) **References Cited**

U.S. PATENT DOCUMENTS

D73,386 S	*	8/1927	Lipschutz	D26/87
D74,129 S	*	12/1927	Wagner	D26/87
D76,062 S	*	8/1928	Shortt	D26/87
D313,868 S	*	1/1991	Shyu	D26/87
D334,349 S	*	3/1993	Maini	D10/114
D394,325 S	*	5/1998	Hsu	D26/87
D455,515 S	*	4/2002	De'Armond et al.	D26/72
D464,163 S	*	10/2002	Orozco	D26/87
D469,558 S	*	1/2003	DiPasquale	D26/67

OTHER PUBLICATIONS

Copy of a logo apparently showing a silhouette of a castle turret. No surface shapes or specifics are shown. Simplicity Plan de Puerto Rico card.

* cited by examiner

Primary Examiner—Clare E Heflin

(74) *Attorney, Agent, or Firm*—John V. Stewart

(57) **CLAIM**

I claim the ornamental design for a lamp, as shown and described.

DESCRIPTION

FIG. 1 is a front/upper perspective view of a lamp according to the invention;

FIG. 2 is a front view;

FIG. 3 is a back view;

FIG. 4 is a bottom view;

FIG. 5 is a top view;

FIG. 6 is a right side view, the left side being a mirror image; and,

FIG. 7 is a sectional view taken along line 7—7 in FIG. 6.

The broken lines transparently show environmental structure that constitutes no part of the claimed invention. The sectional view of FIG. 7 is provided only for the purpose of additional disclosure of the external shape of the invention.

1 Claim, 4 Drawing Sheets

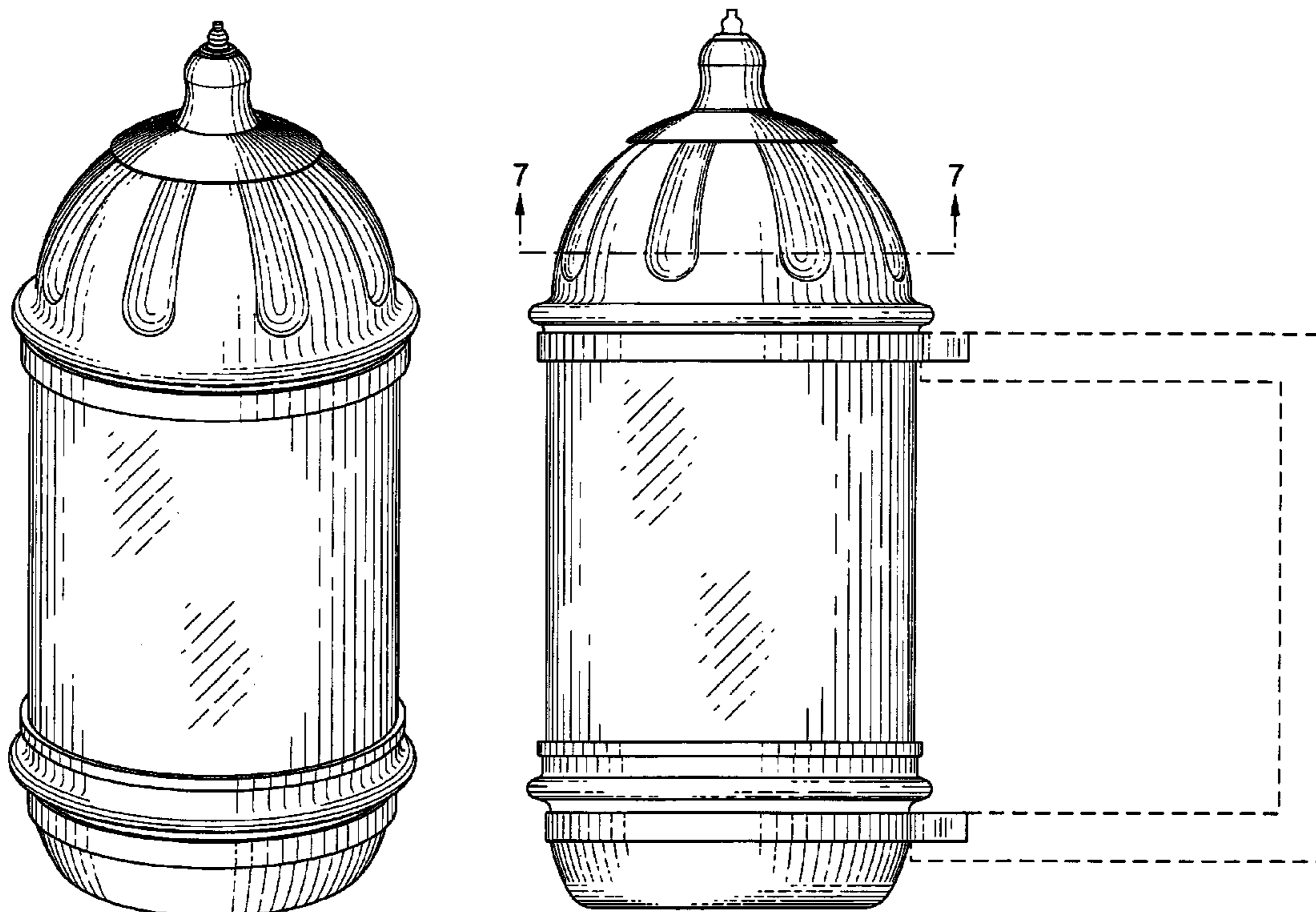
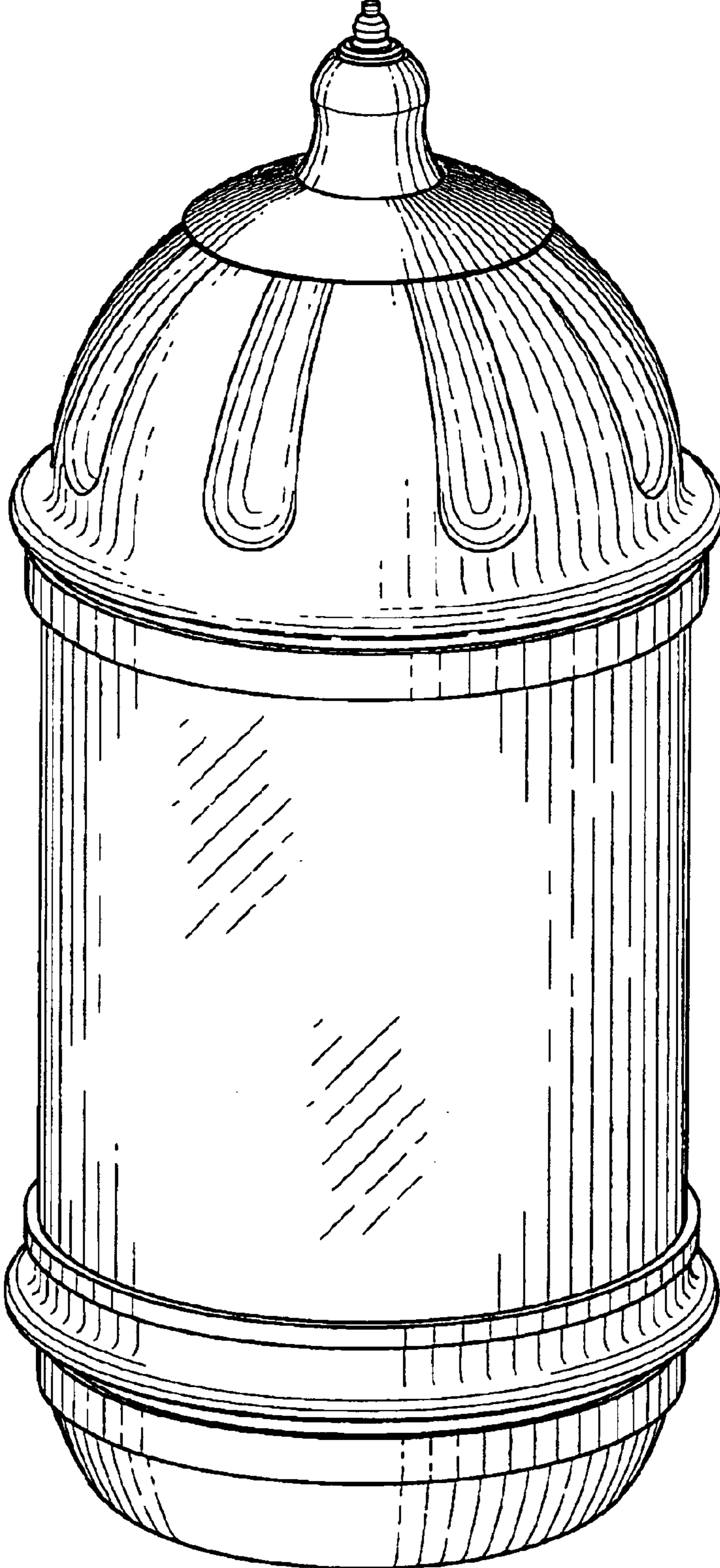
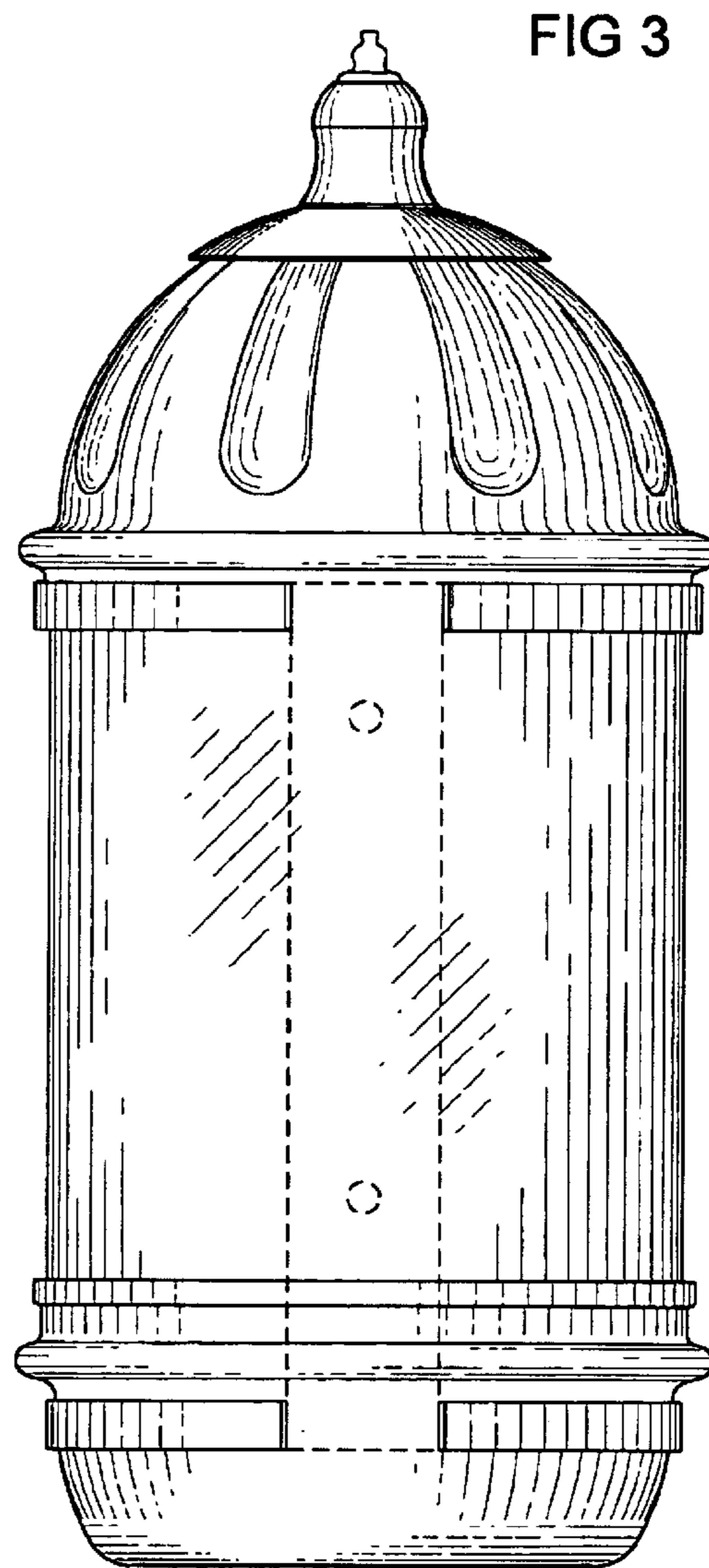
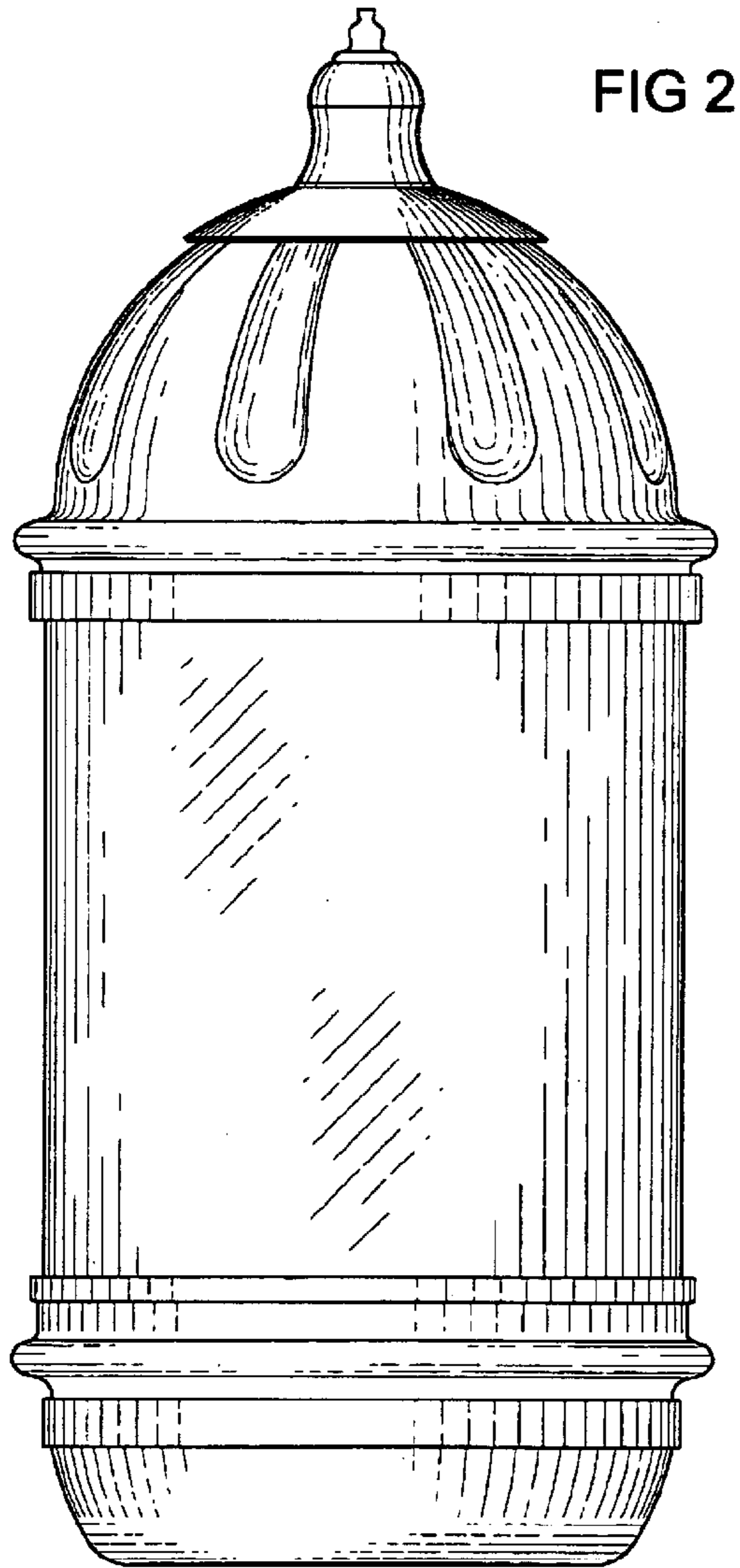

FIG 1





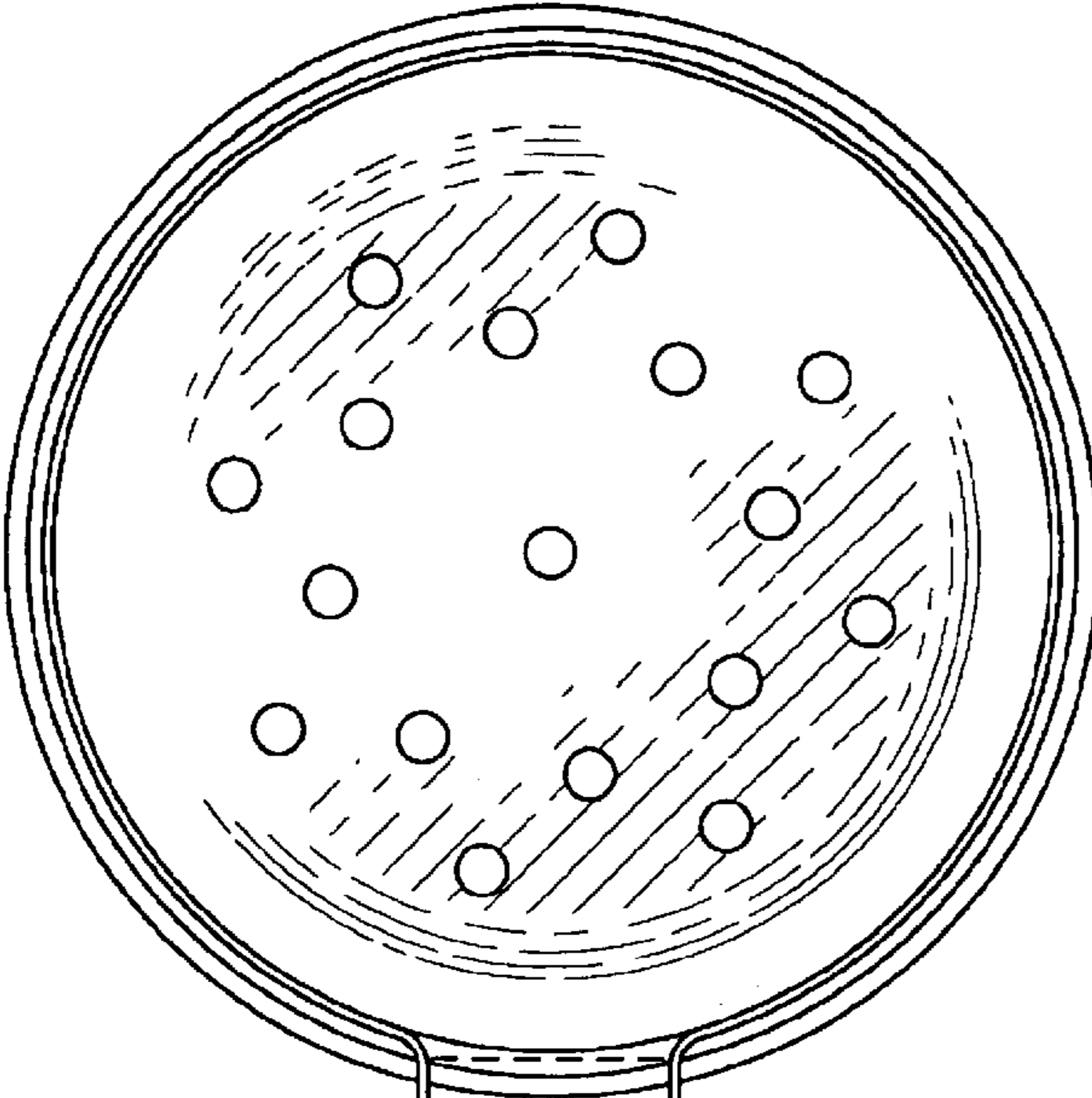

FIG 4

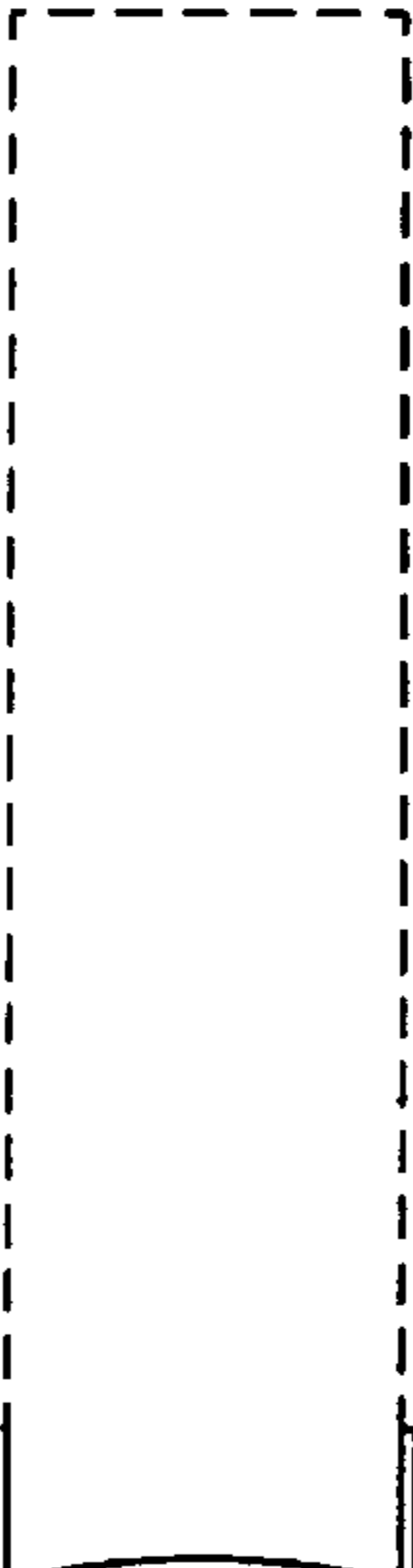

FIG 5

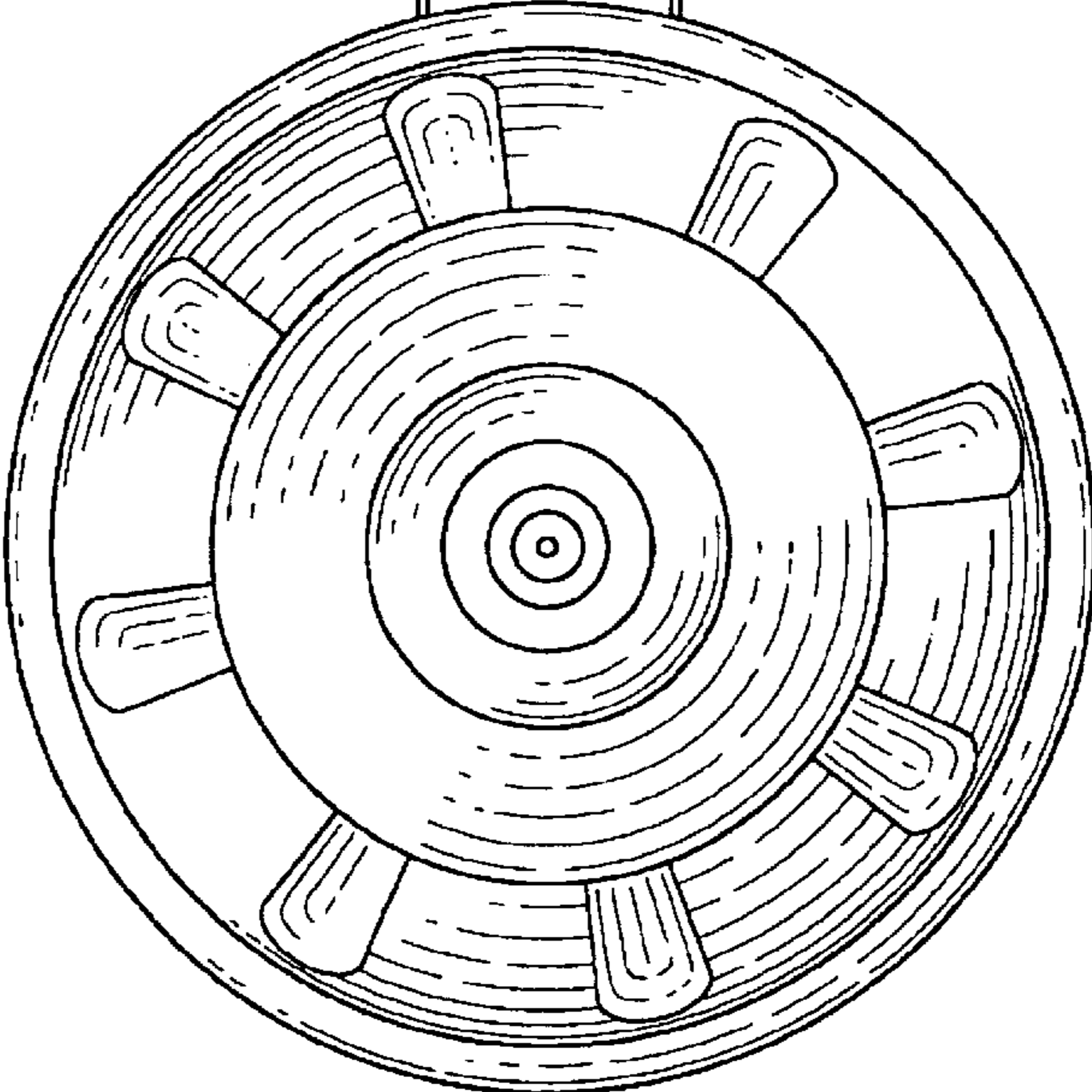

FIG 6

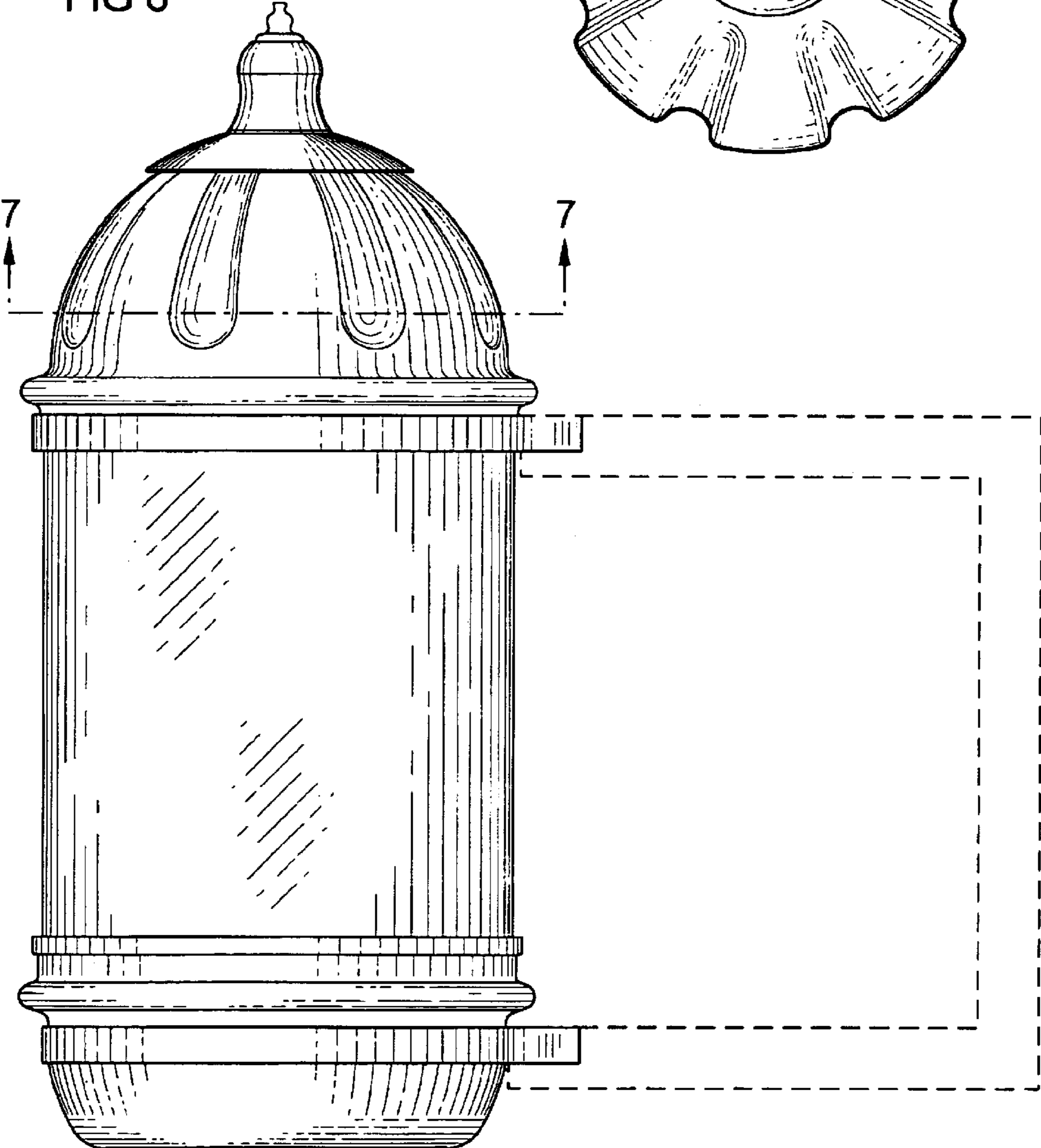

FIG 7

