



US00D515136S

(12) **United States Design Patent** (10) **Patent No.:** **US D515,136 S**
Herrmannsen et al. (45) **Date of Patent:** **** Feb. 14, 2006**

(54) **CORRECTION TAPE**

(75) Inventors: **Wulf Herrmannsen**, Ronnenberg (DE);
Corine Van Zuthem-Maasdam,
Barcelona (ES); **Lutz Paulus**, Neuss
(DE); **Ulf Plihal**, Cologne (DE)

(73) Assignee: **Henkel Kommanditgesellschaft auf
Aktien**, Duesseldorf (DE)

(**) Term: **14 Years**

(21) Appl. No.: **29/224,978**

(22) Filed: **Mar. 9, 2005**

D400,585 S 11/1998 Fritz et al.
D410,494 S 6/1999 Hoffmann
D410,955 S 6/1999 Hoffmann
D421,060 S 2/2000 Kelders et al.
D424,619 S * 5/2000 Katami D19/69
6,112,796 A 9/2000 Stevens
D436,129 S * 1/2001 Fujihara D19/53
D447,180 S 8/2001 Stropkay et al.
D448,416 S * 9/2001 Kimura D19/69
D449,858 S * 10/2001 Liu D19/69
D457,564 S * 5/2002 Kimura D19/53
D465,241 S * 11/2002 Suzuki D19/69
D466,939 S * 12/2002 Lee D19/69
D470,531 S * 2/2003 Altmann et al. D19/69
D492,355 S * 6/2004 Suzuki D19/69
2003/0205332 A1 * 11/2003 Shinya 156/577

Related U.S. Application Data

(62) Division of application No. 29/201,550, filed on Mar. 17,
2004.

(51) **LOC (8) Cl.** **19-02**

(52) **U.S. Cl.** **D19/69**

(58) **Field of Classification Search** D19/66,
D19/67, 68, 69, 70; 156/523, 527, 540, 577;
206/411; 225/6, 25, 39, 77; 242/588, 588.1,
242/588.2, 588.3, 588.6, 598.5

See application file for complete search history.

(56) **References Cited**

U.S. PATENT DOCUMENTS

4,324,603 A * 4/1982 Crandall et al. 156/584
D315,109 S * 3/1991 Ingram, II et al. D10/72
D328,098 S * 7/1992 Czech D19/69
D330,566 S * 10/1992 Czech D19/69
D348,691 S * 7/1994 Bell et al. D19/69
D368,115 S * 3/1996 Kouda D19/69
5,759,270 A 6/1998 Lee

* cited by examiner

Primary Examiner—Jeffrey Asch

Assistant Examiner—Elizabeth Albert

(74) *Attorney, Agent, or Firm*—Stephen D. Harper; Glenn
E.J. Murphy

(57) **CLAIM**

The ornamental design for a correction tape, as shown and
described.

DESCRIPTION

FIG. 1 is a top right perspective view of a correction tape
according to the new design;

FIG. 2 is a right elevation view thereof;

FIG. 3 is a left elevation view thereof;

FIG. 4 is a front elevation view thereof;

FIG. 5 is a back elevation view thereof;

FIG. 6 is a top plan view thereof; and,

FIG. 7 is a bottom plan view thereof.

1 Claim, 3 Drawing Sheets

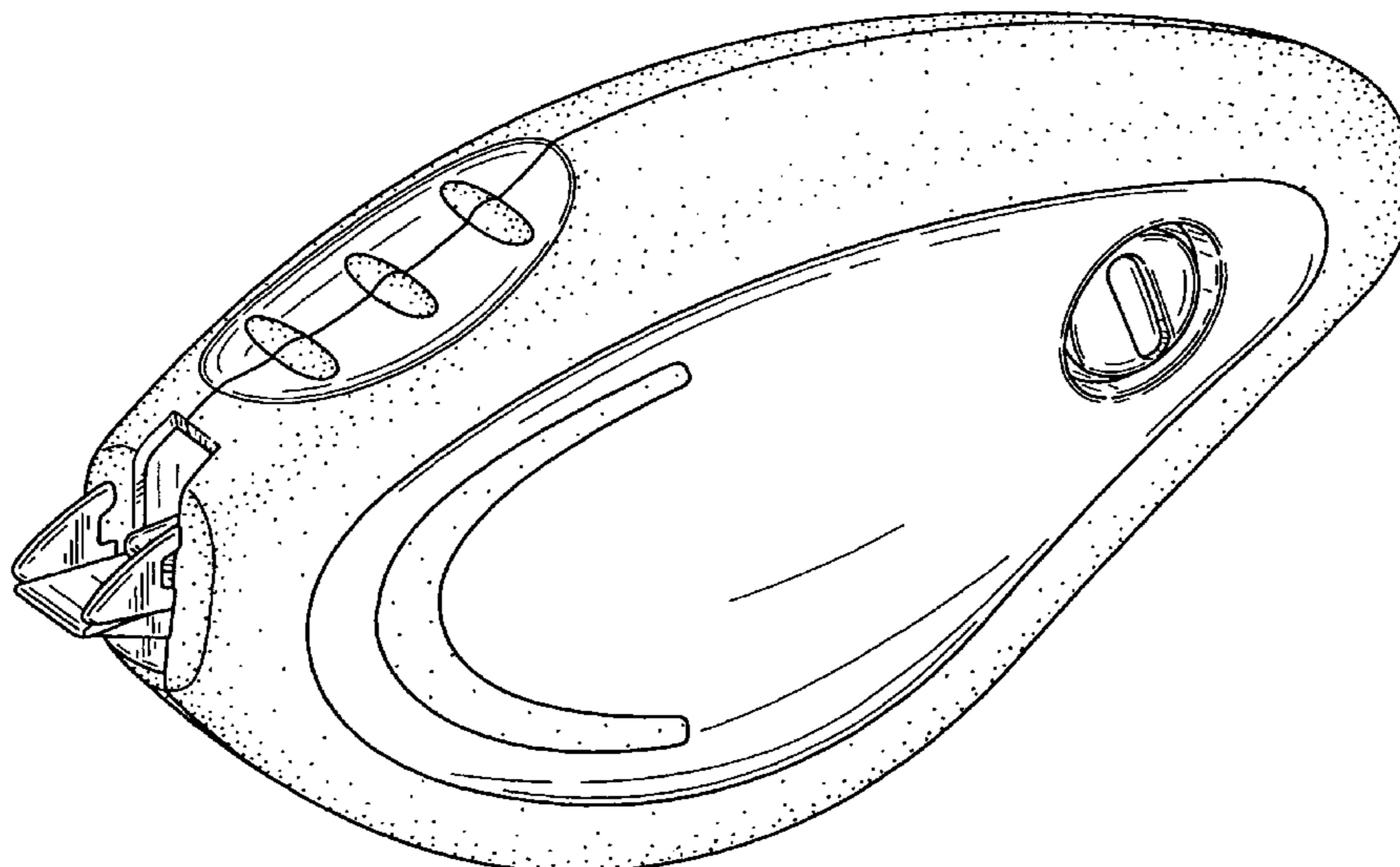

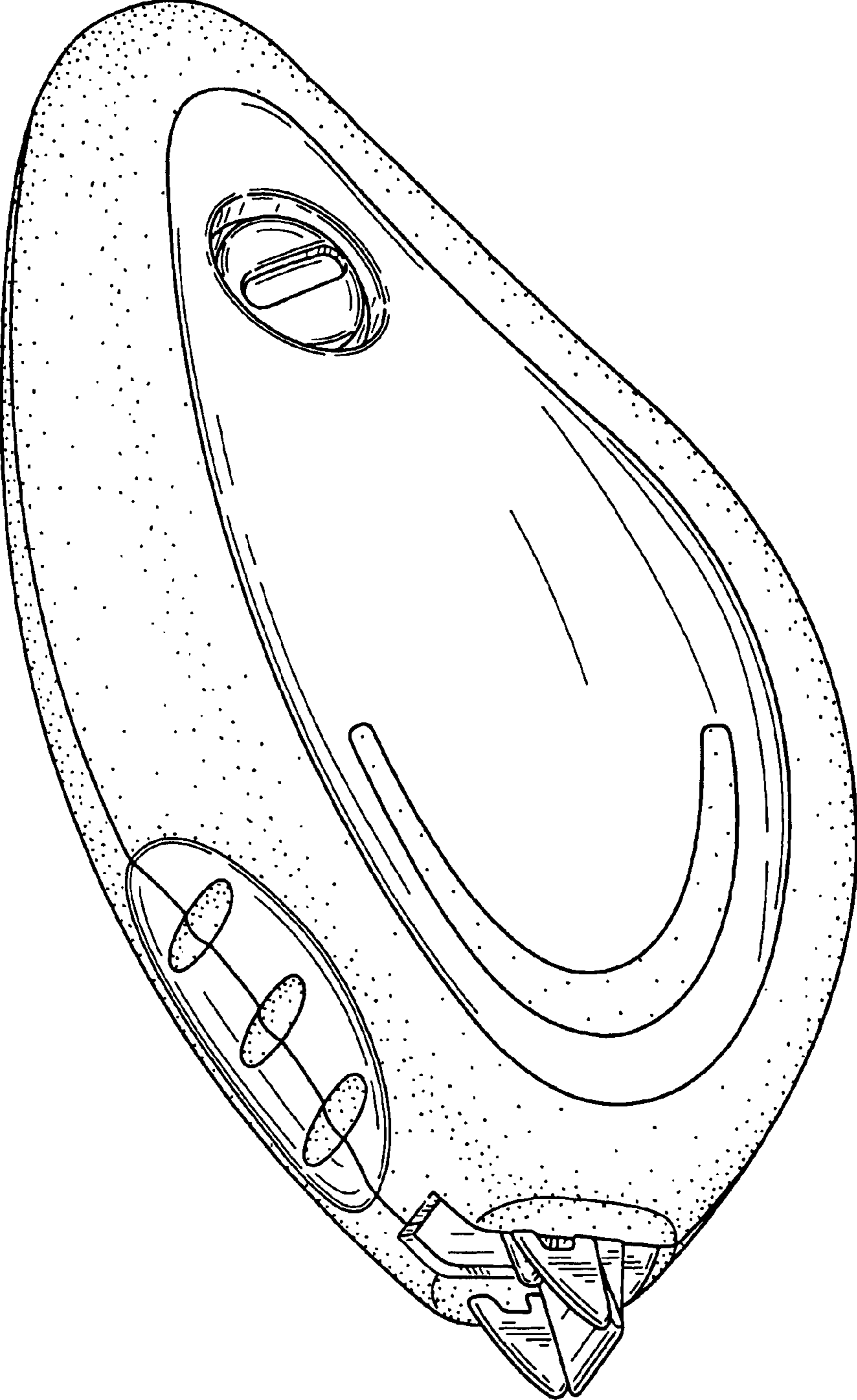

FIG. 1

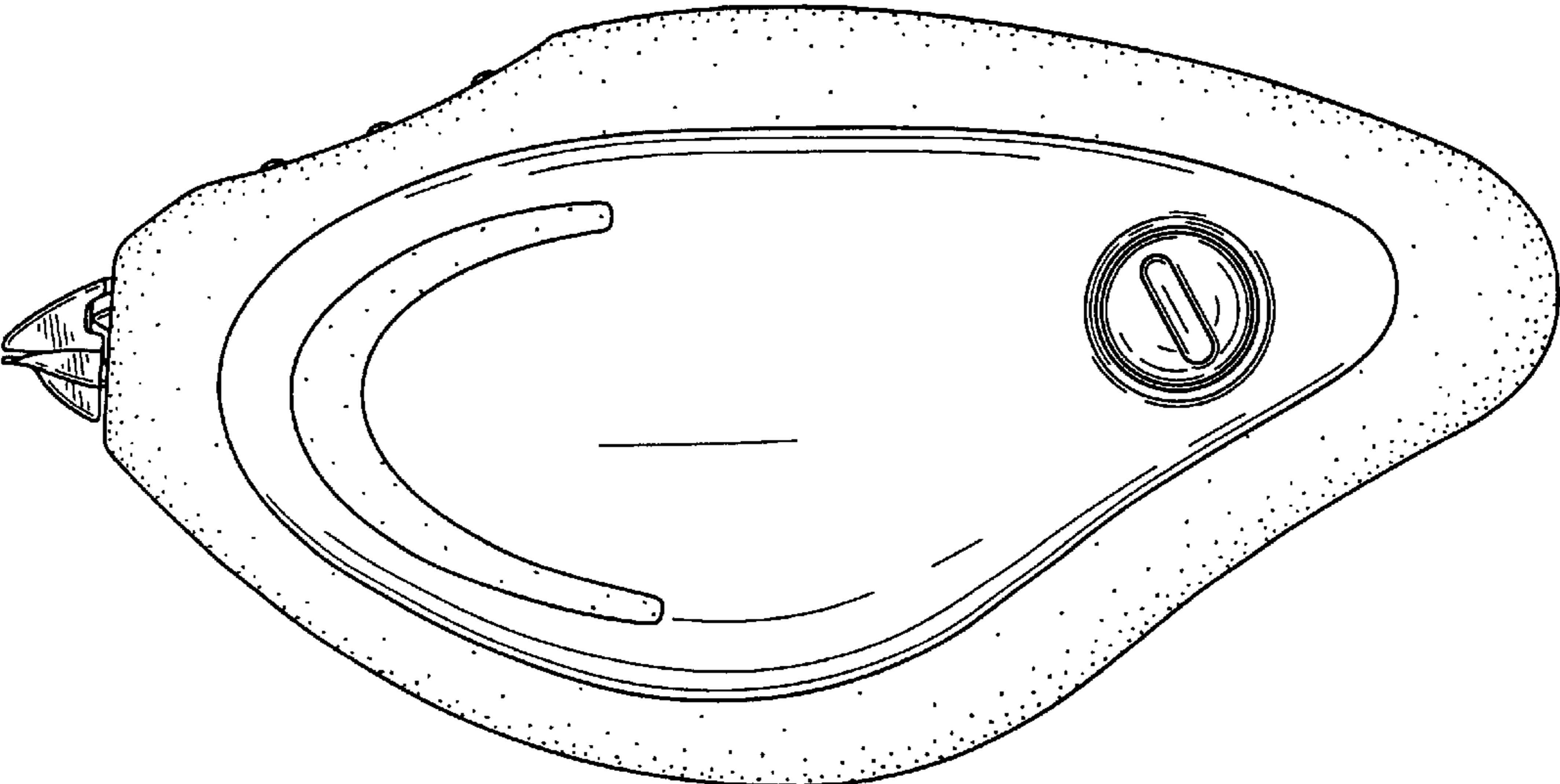

FIG. 2

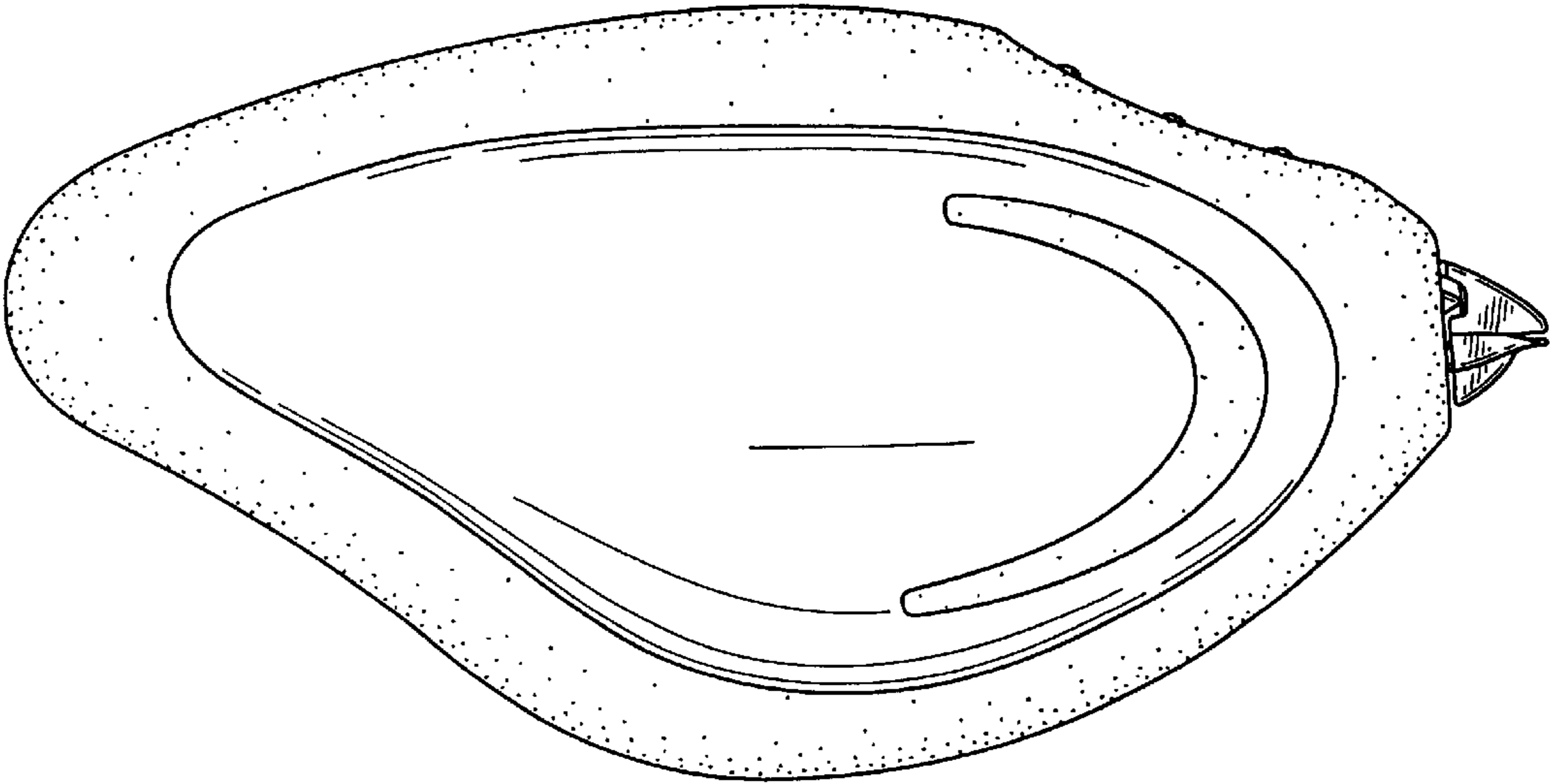

FIG. 3

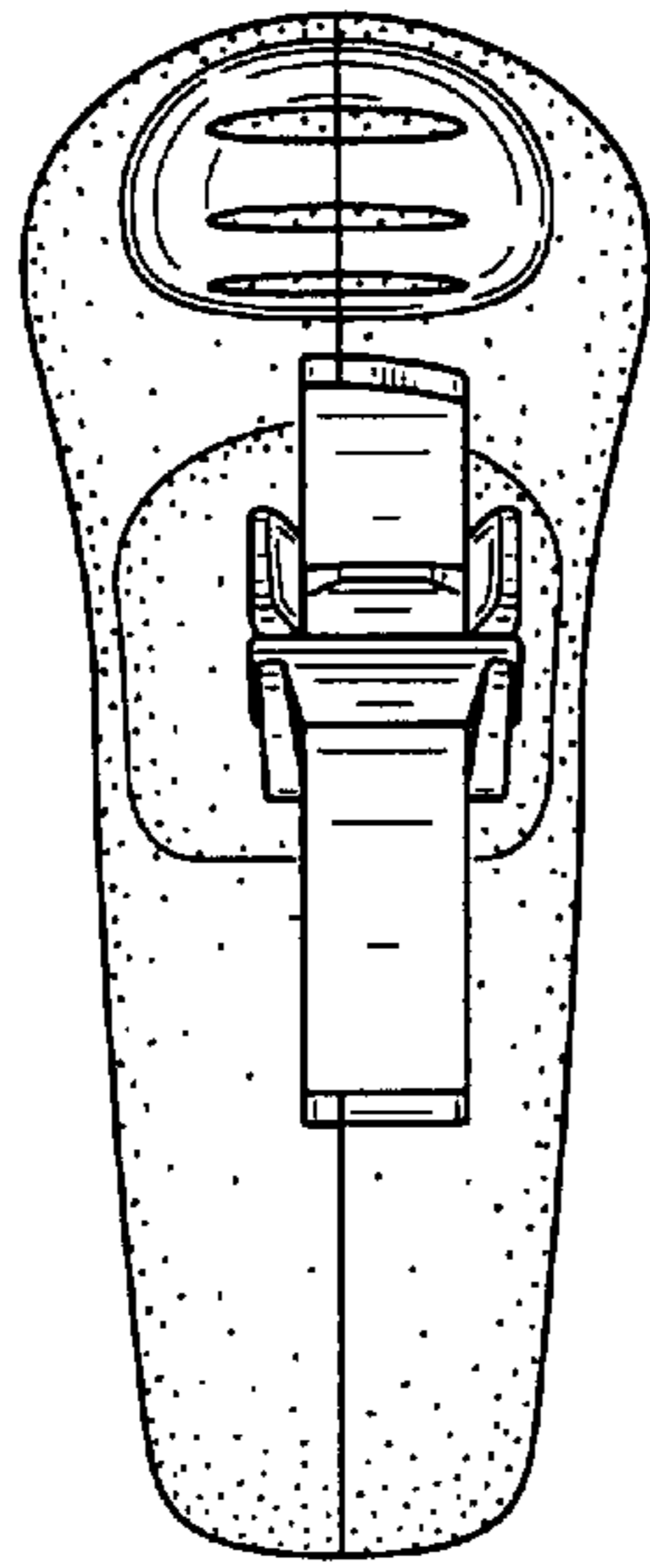

FIG. 4

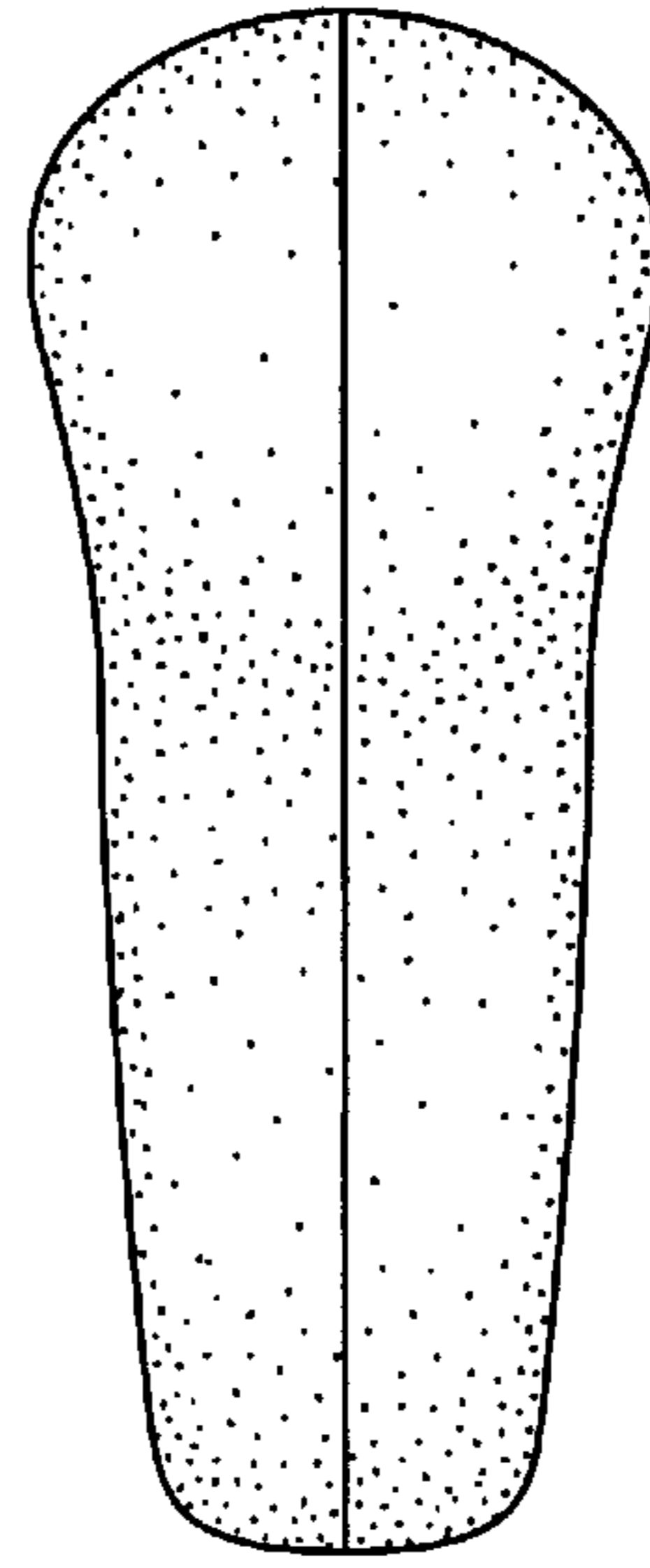

FIG. 5

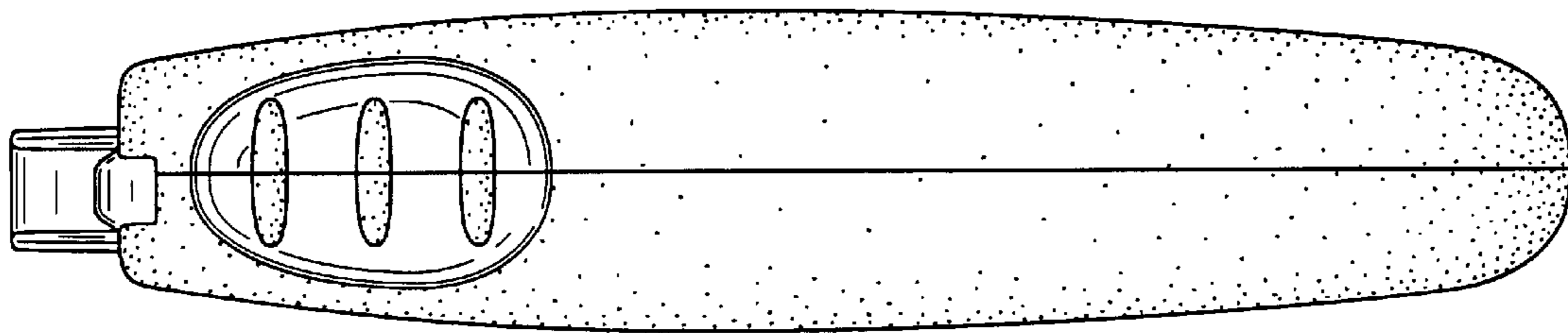

FIG. 6

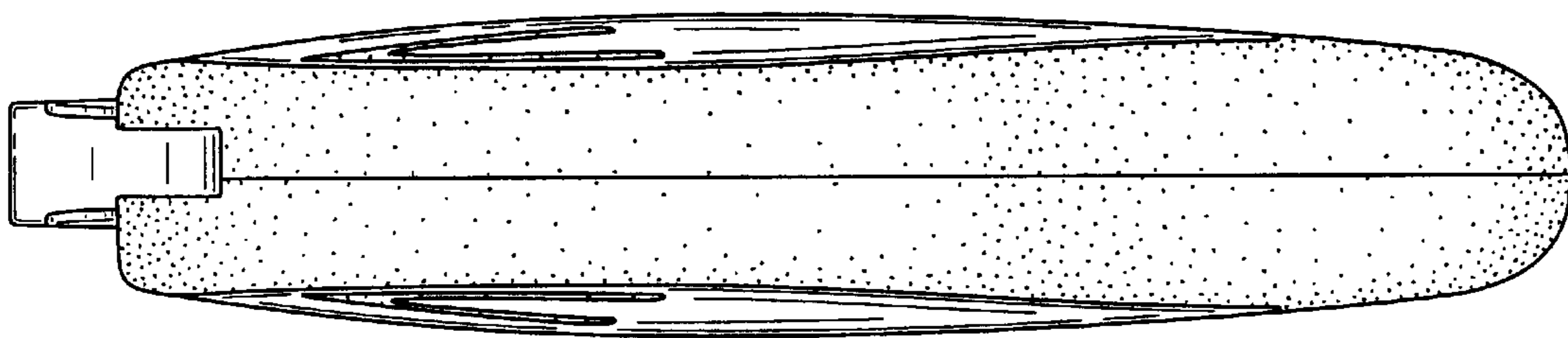

FIG. 7