



US00D515099S

(12) **United States Design Patent**
Lee

(10) **Patent No.: US D515,099 S**
(45) **Date of Patent: ** Feb. 14, 2006**

(54) **DIGITAL AUDIO PLAYER**
(75) **Inventor: Myoung-Yong Lee, Goyang-Si (KR)**
(73) **Assignee: Cowon Systems, Inc. (KR)**
(**) **Term: 14 Years**

D492,665 S * 7/2004 Lee D14/218
D493,779 S * 8/2004 Lee D14/156
D496,668 S * 9/2004 Huang D14/496
6,791,907 B2 * 9/2004 Berhan 369/7
D497,618 S * 10/2004 Andre et al. D14/496
D499,424 S * 12/2004 Bahroocha D14/496
D504,409 S * 4/2005 Kim D14/156
D504,442 S * 4/2005 Kim D14/496

(21) **Appl. No.: 29/214,765**
(22) **Filed: Oct. 7, 2004**
(30) **Foreign Application Priority Data**
Sep. 10, 2004 (KR) 30-2004-0028082

OTHER PUBLICATIONS

New Dell DJ20 1999–2005 (C), From Dell Web Page.*
Samsung YP-T5V, 2005 (C), From Web Page.*
San Disk Digitl Audio Player From Web Page.*

(51) **LOC (8) Cl. 14-03**
(52) **U.S. Cl. D14/496**
(58) **Field of Classification Search D14/496,**
D14/435, 474, 483, 217, 188, 204, 156, 157,
D14/160, 167, 168; 369/1, 2, 75.11, 86, 99,
369/12; 370/342–344; 455/344–351; 273/148 B;
463/1, 43–47

* cited by examiner

Primary Examiner—Prabhakar Deshmukh
(74) *Attorney, Agent, or Firm*—Cantor Colburn LLP

See application file for complete search history.

(57) **CLAIM**

I claim, the ornamental design for a digital audio player, as shown and described.

(56) **References Cited**

DESCRIPTION

U.S. PATENT DOCUMENTS

5,349,575 A * 9/1994 Park 369/1
5,859,594 A * 1/1999 King et al. 340/7.55
6,041,023 A * 3/2000 Lakhansingh 369/7
6,122,526 A * 9/2000 Parulski et al. 455/556.1
D452,226 S * 12/2001 Simpson et al. D14/167
6,606,281 B2 * 8/2003 Cowgill et al. 369/11
D489,052 S * 4/2004 Shiraki et al. D14/156

FIG. 1 is a top and front perspective view of a digital audio player, showing my new design;
FIG. 2 is a front view thereof;
FIG. 3 is a rear view thereof;
FIG. 4 is a left side view thereof;
FIG. 5 is a right side view thereof;
FIG. 6 is a top plan view thereof; and,
FIG. 7 is a bottom plan view thereof.

1 Claim, 6 Drawing Sheets

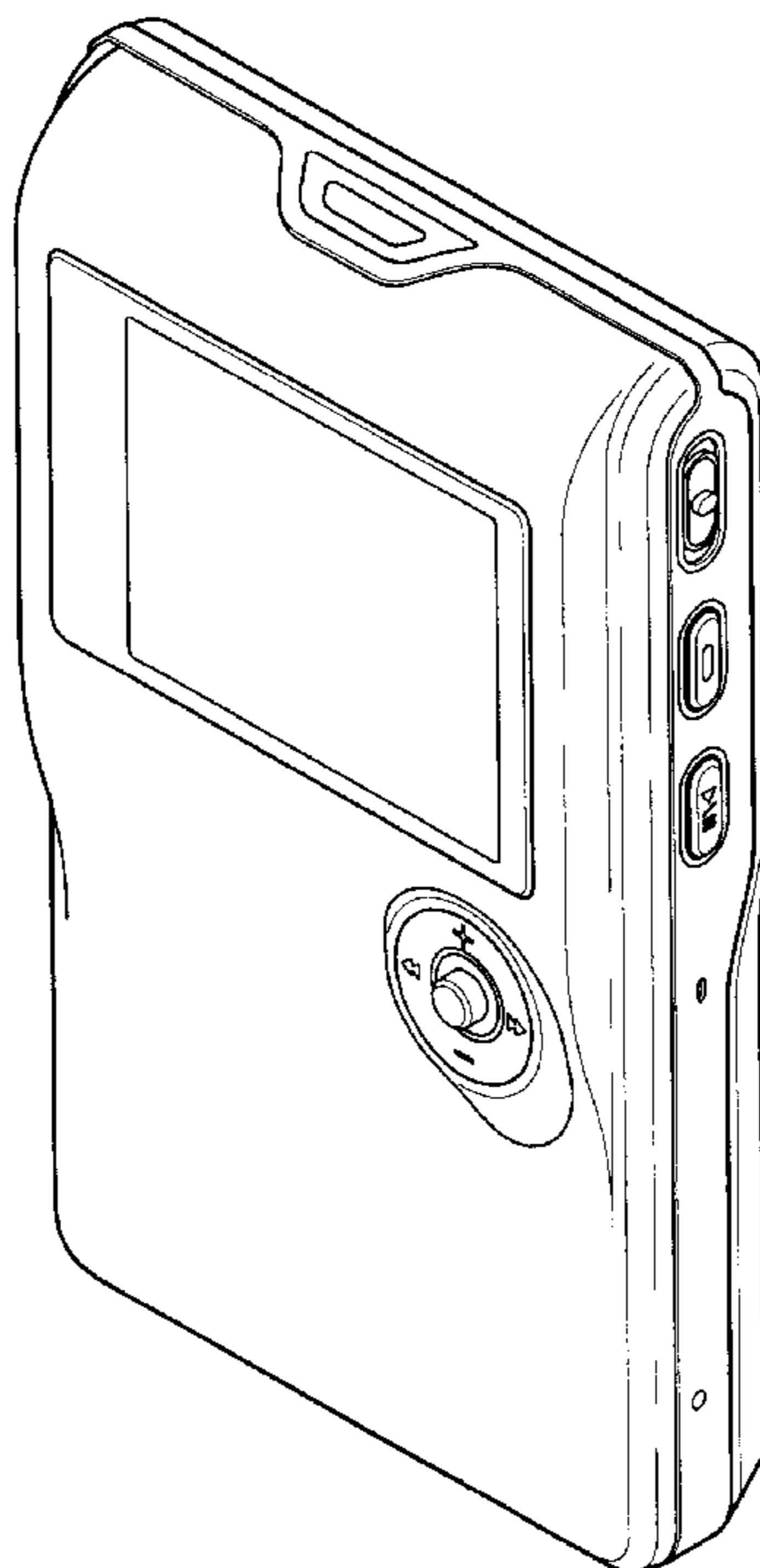

Fig. 1

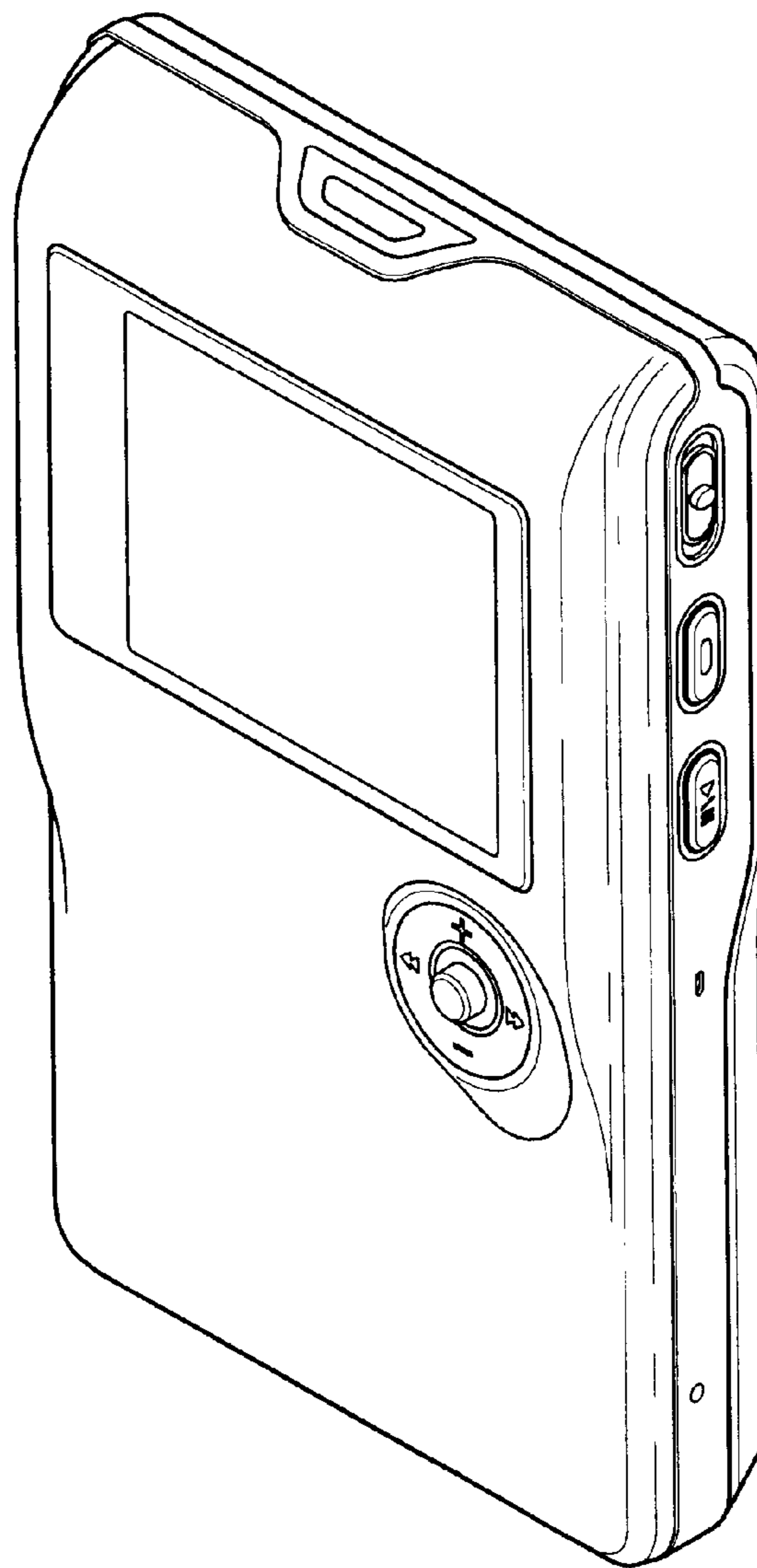

Fig.2

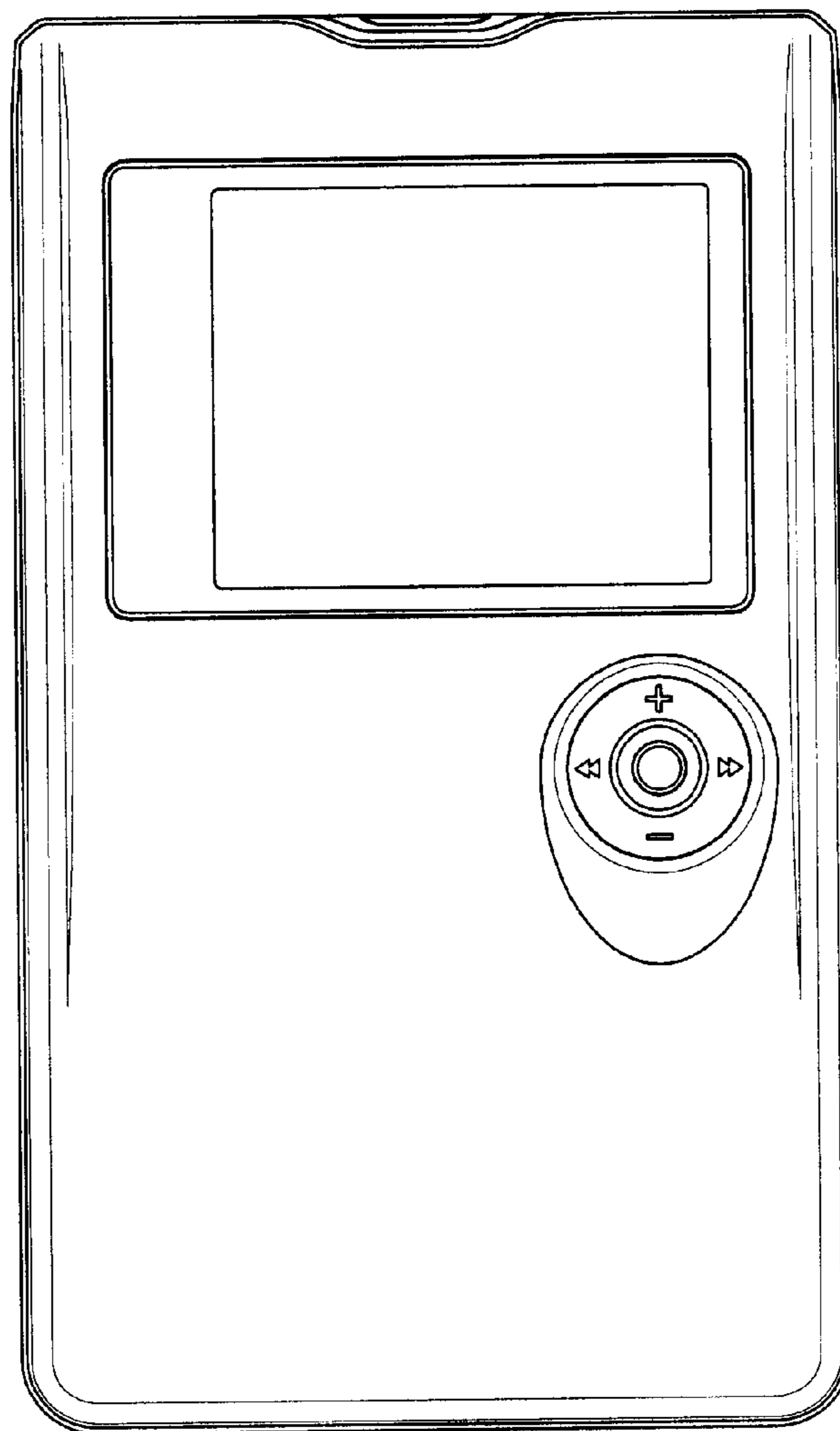

Fig.3

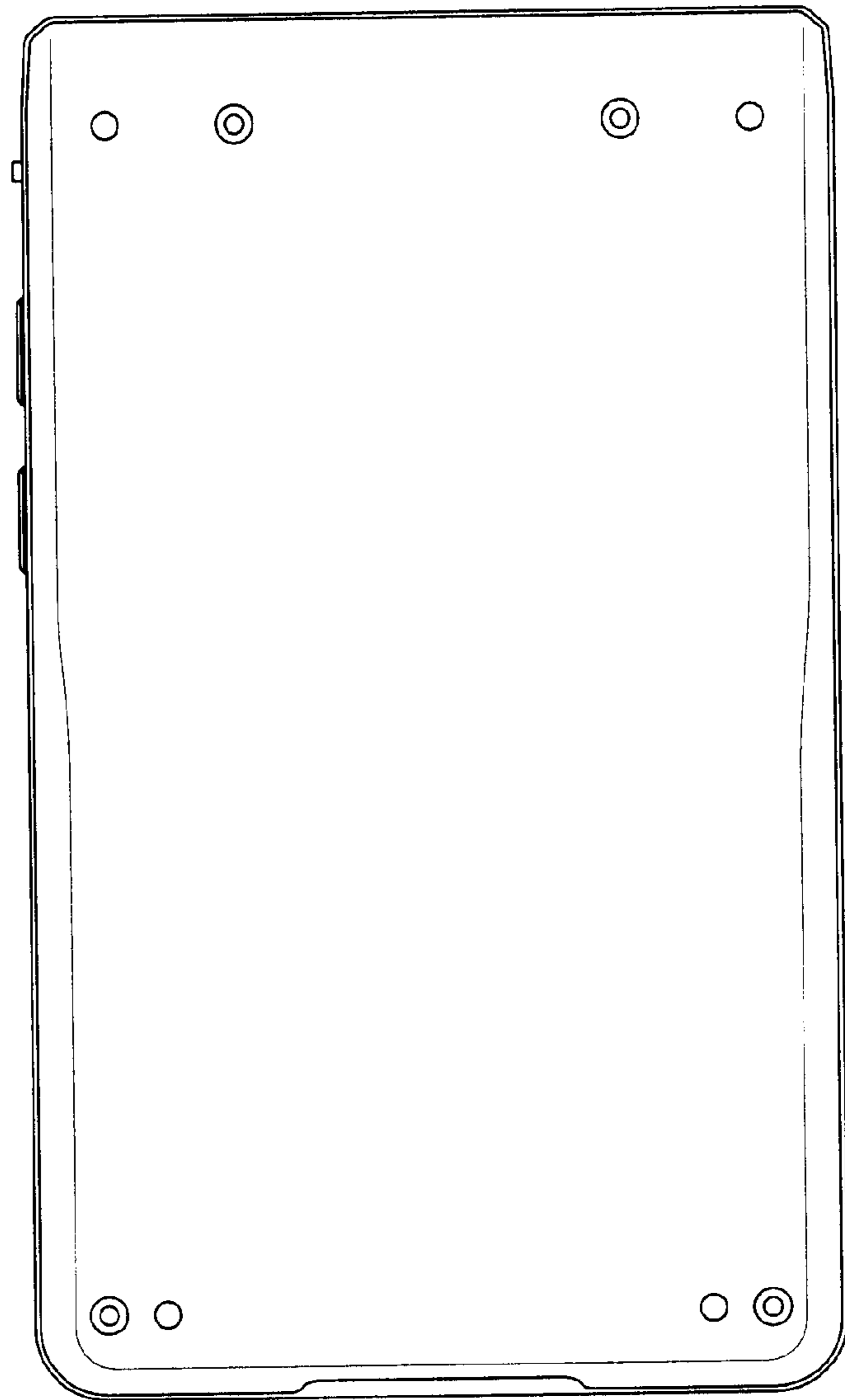

Fig.4

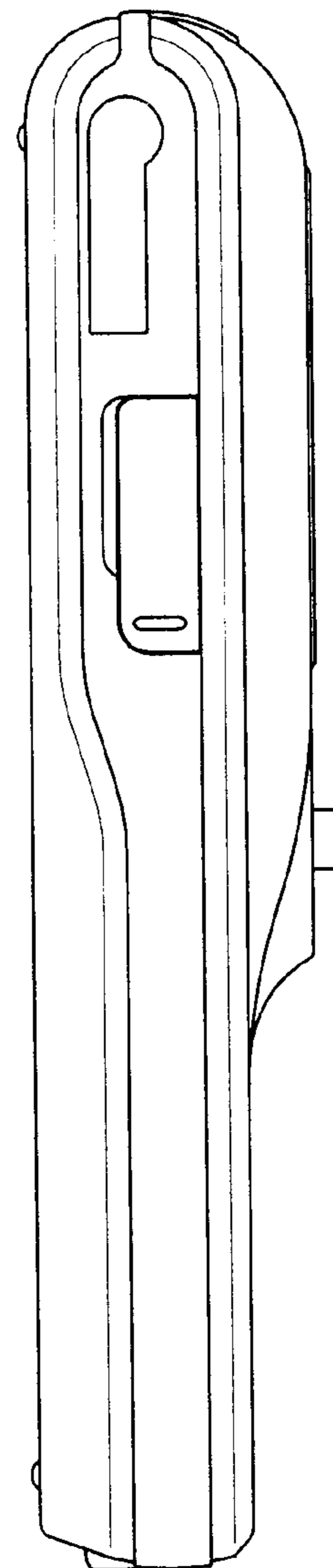

Fig.5

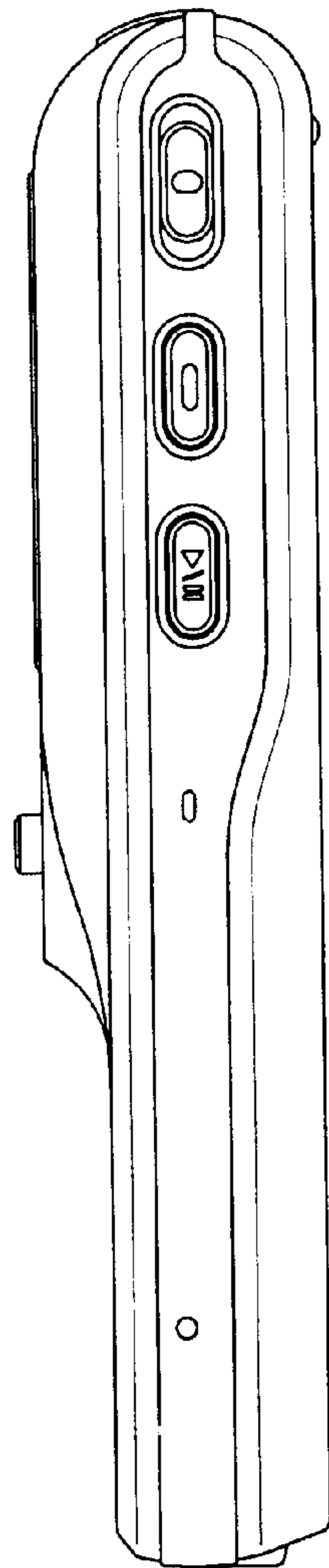

Fig.6

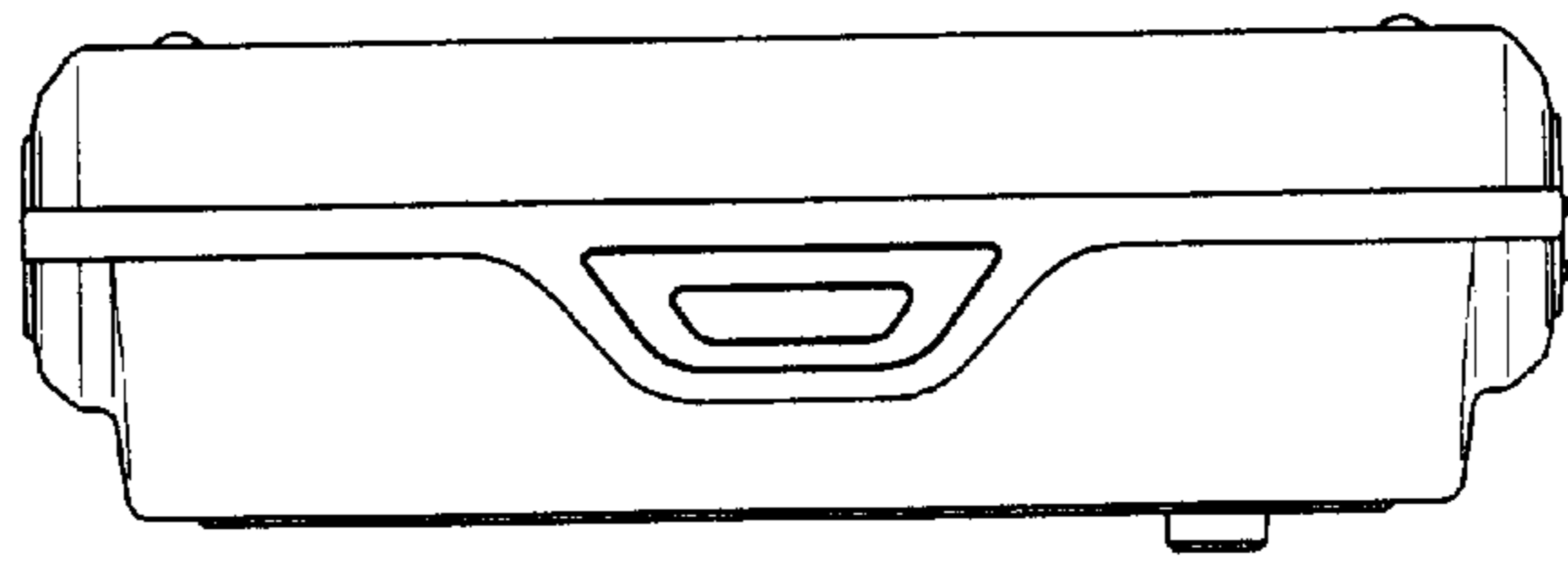

Fig.7

