



US00D515094S

(12) **United States Design Patent**
Kawami et al.

(10) **Patent No.:** **US D515,094 S**

(45) **Date of Patent:** **** Feb. 14, 2006**

(54) **PERSONAL COMPUTER**

D452,686 S * 1/2002 Chen et al. D14/318

(75) Inventors: **Mitsuhiko Kawami**, Tokyo (JP);
Masaki Kanayama, Tachikawa (JP)

* cited by examiner

(73) Assignee: **Fujitsu Limited**, Kawasaki (JP)

Primary Examiner—Alan P. Douglas

Assistant Examiner—Susan Moon Lee

(74) *Attorney, Agent, or Firm*—Staas & Halsey LLP

(**) Term: **14 Years**

(57) **CLAIM**

(21) Appl. No.: **29/212,287**

The ornamental design for a personal computer, as shown and described.

(22) Filed: **Aug. 31, 2004**

DESCRIPTION

(30) **Foreign Application Priority Data**

Mar. 9, 2004 (JP) 2004-006950

FIG. 1 is a perspective view of the top, rear and right side of a personal computer showing our new design;

(51) **LOC (8) Cl.** **14-02**

FIG. 2 is a front view thereof;

(52) **U.S. Cl.** **D14/439**

FIG. 3 is a rear view thereof;

(58) **Field of Classification Search** D14/315-319,

FIG. 4 is a top plan view thereof;

D14/439, 441, 432, 322-327; 361/683, 686

FIG. 5 is a bottom view thereof;

See application file for complete search history.

FIG. 6 is a right side view thereof; and,

FIG. 7 is a left side view thereof.

(56) **References Cited**

The portions of the article in broken lines are shown for illustrative purposes only and form no part of the claimed design.

U.S. PATENT DOCUMENTS

D430,869 S * 9/2000 Lee et al. D14/318

1 Claim, 7 Drawing Sheets

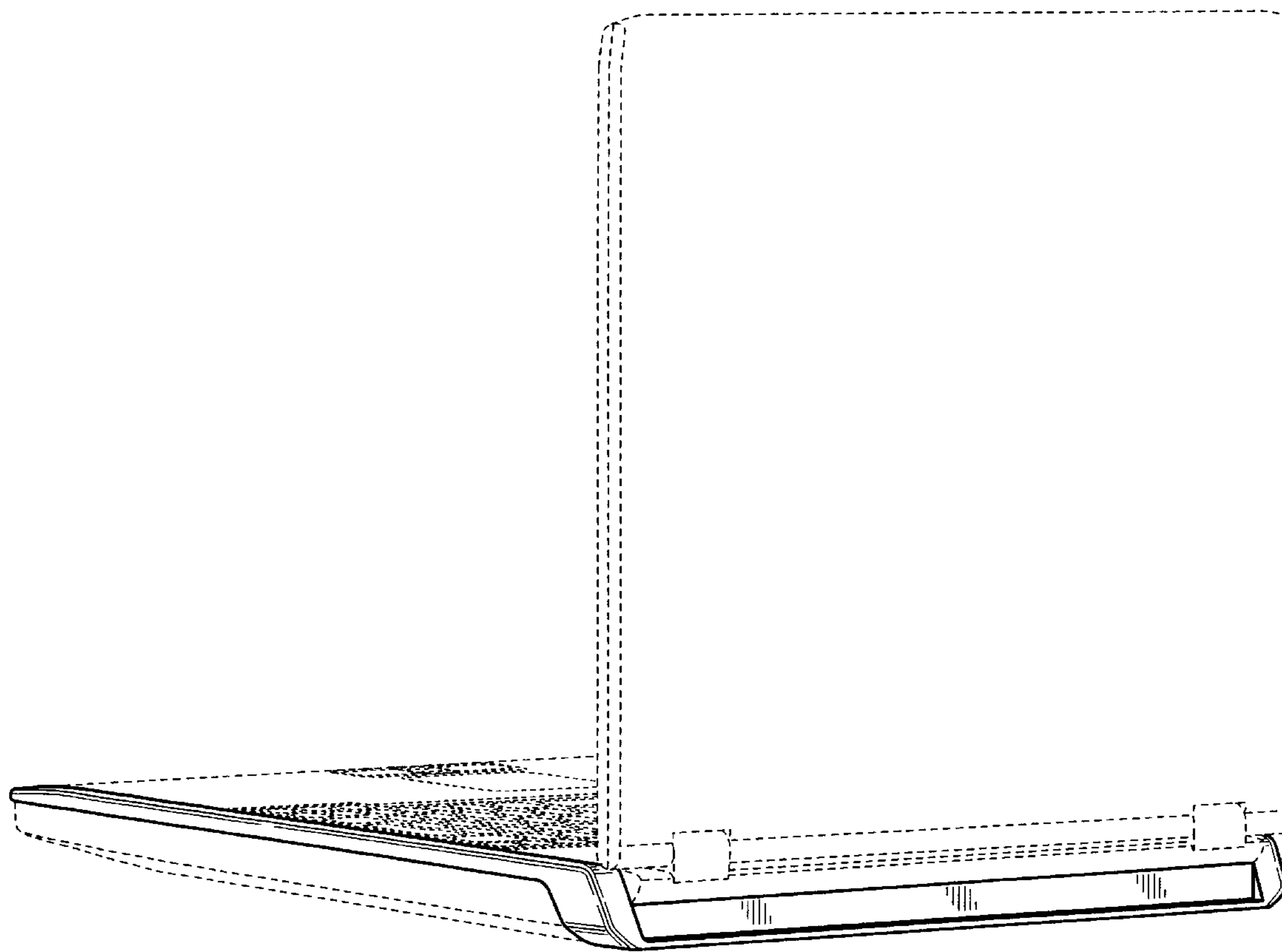

FIG. 1

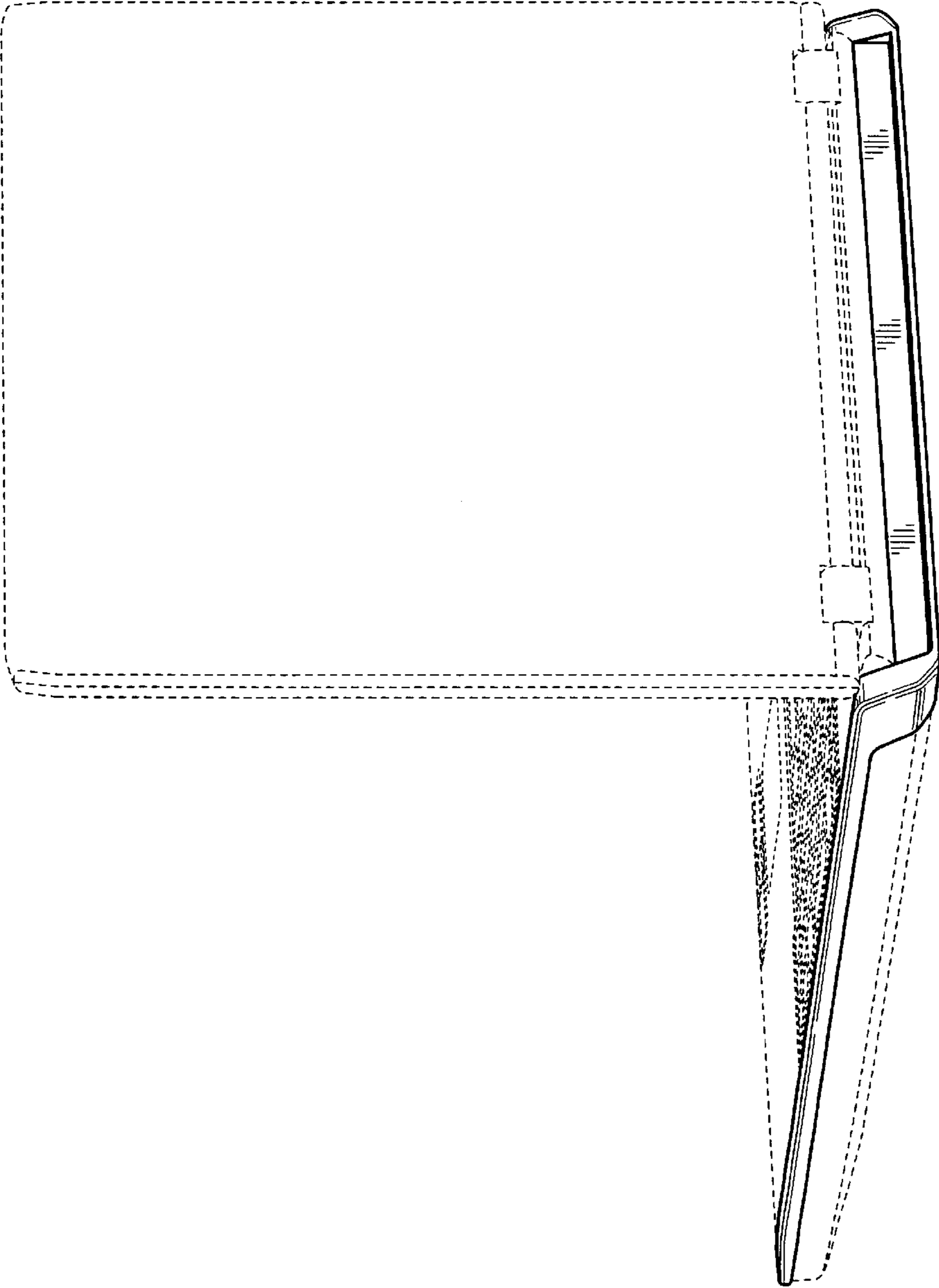

FIG. 2

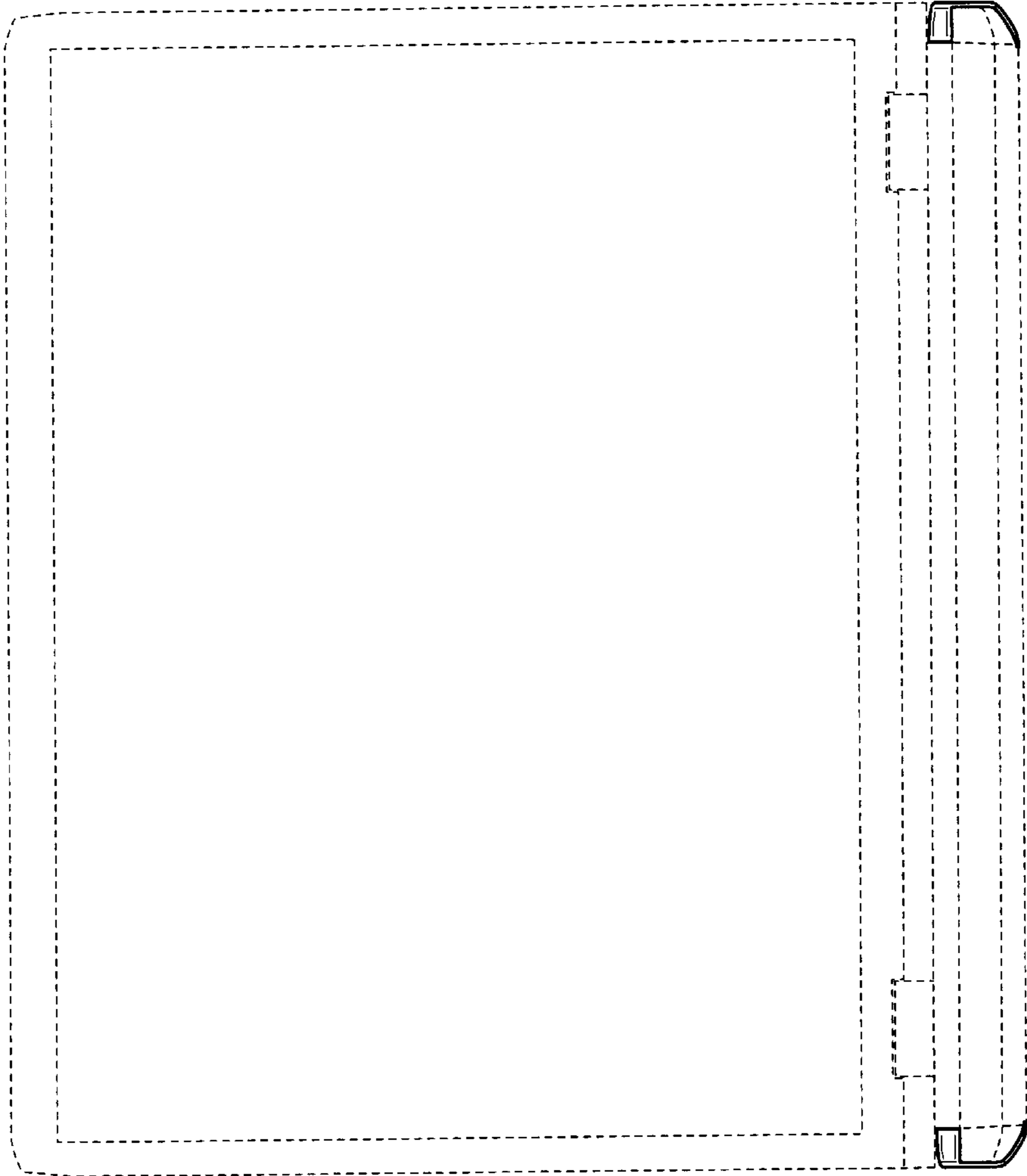

FIG. 3

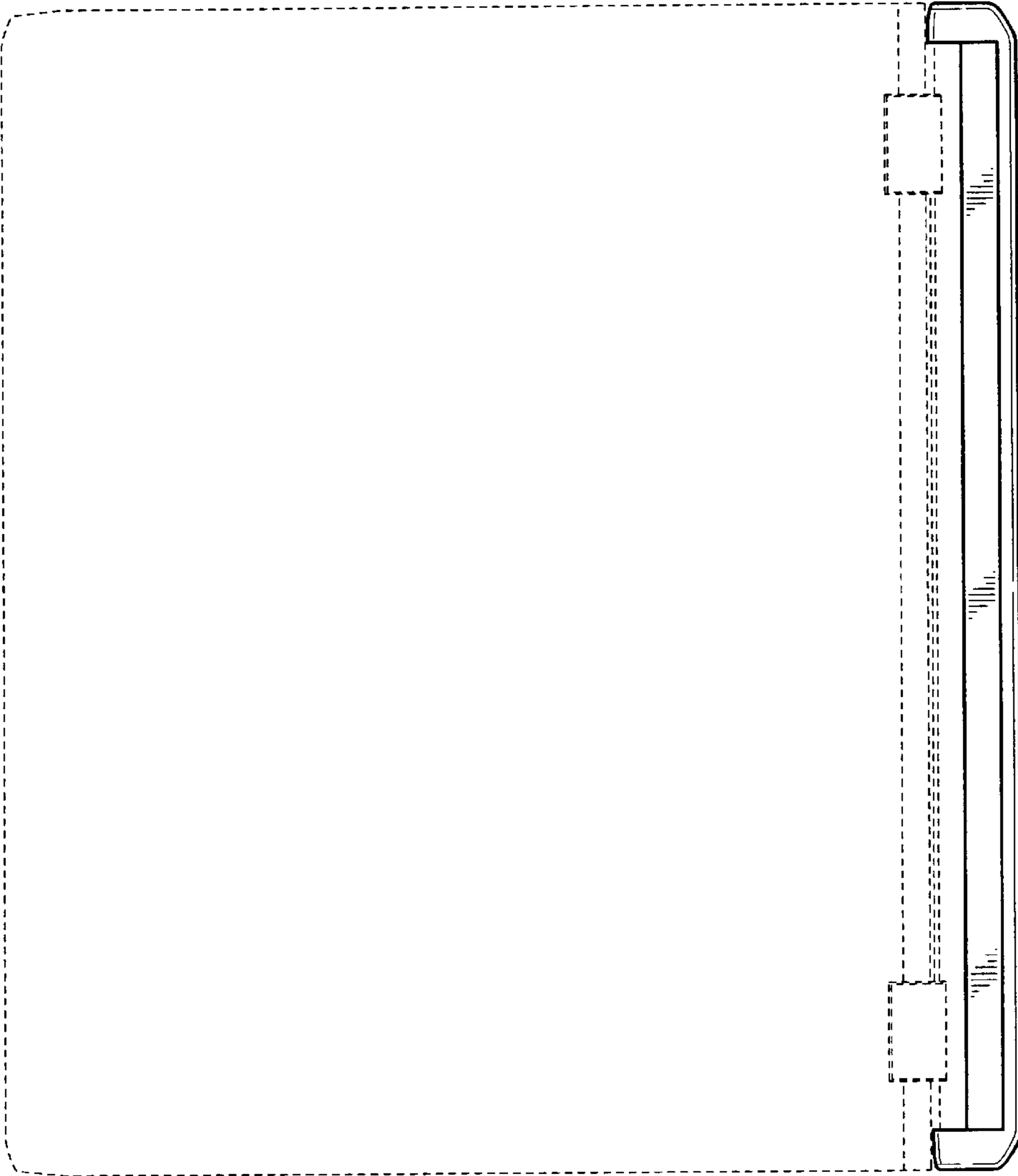

FIG. 4

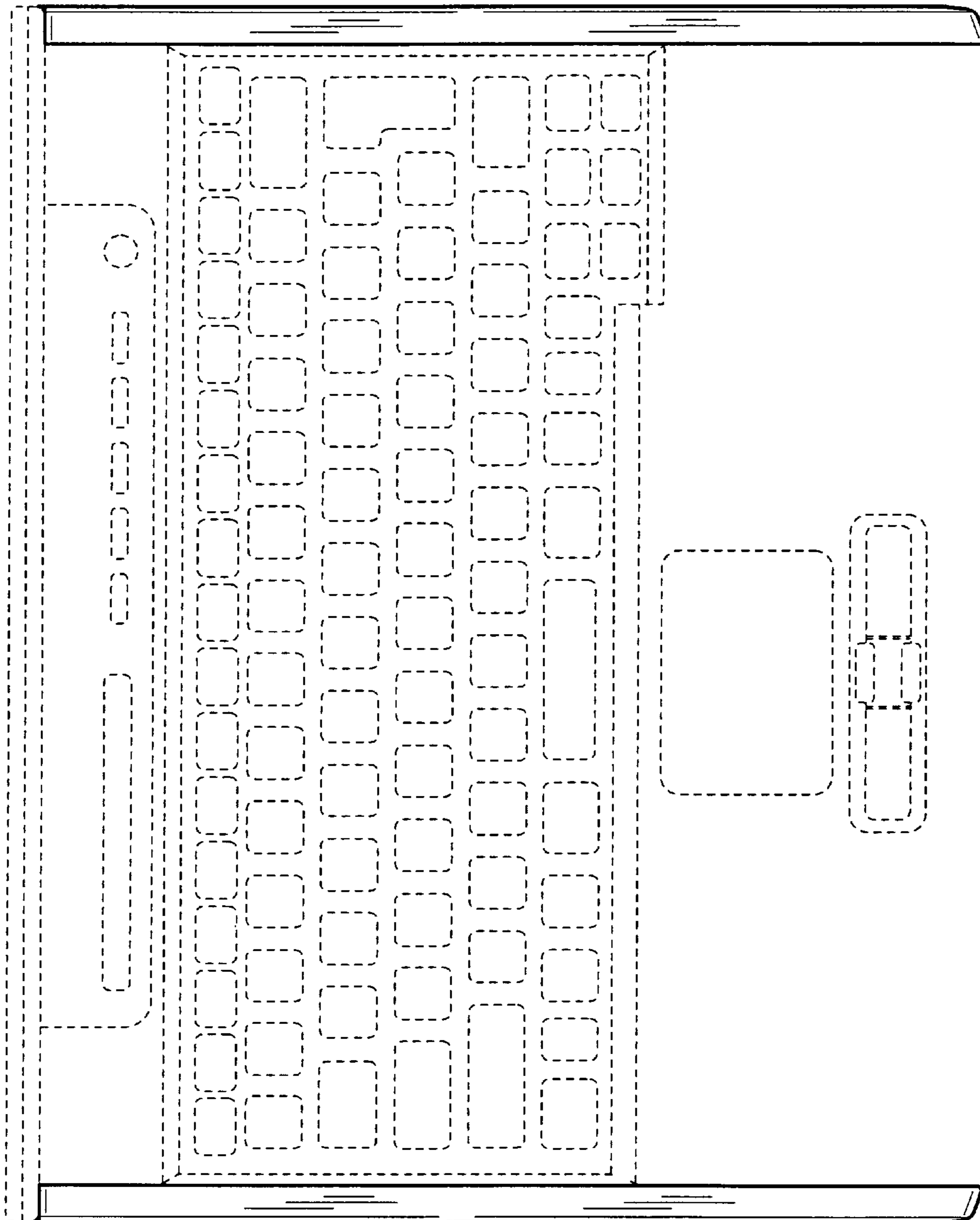

FIG. 5

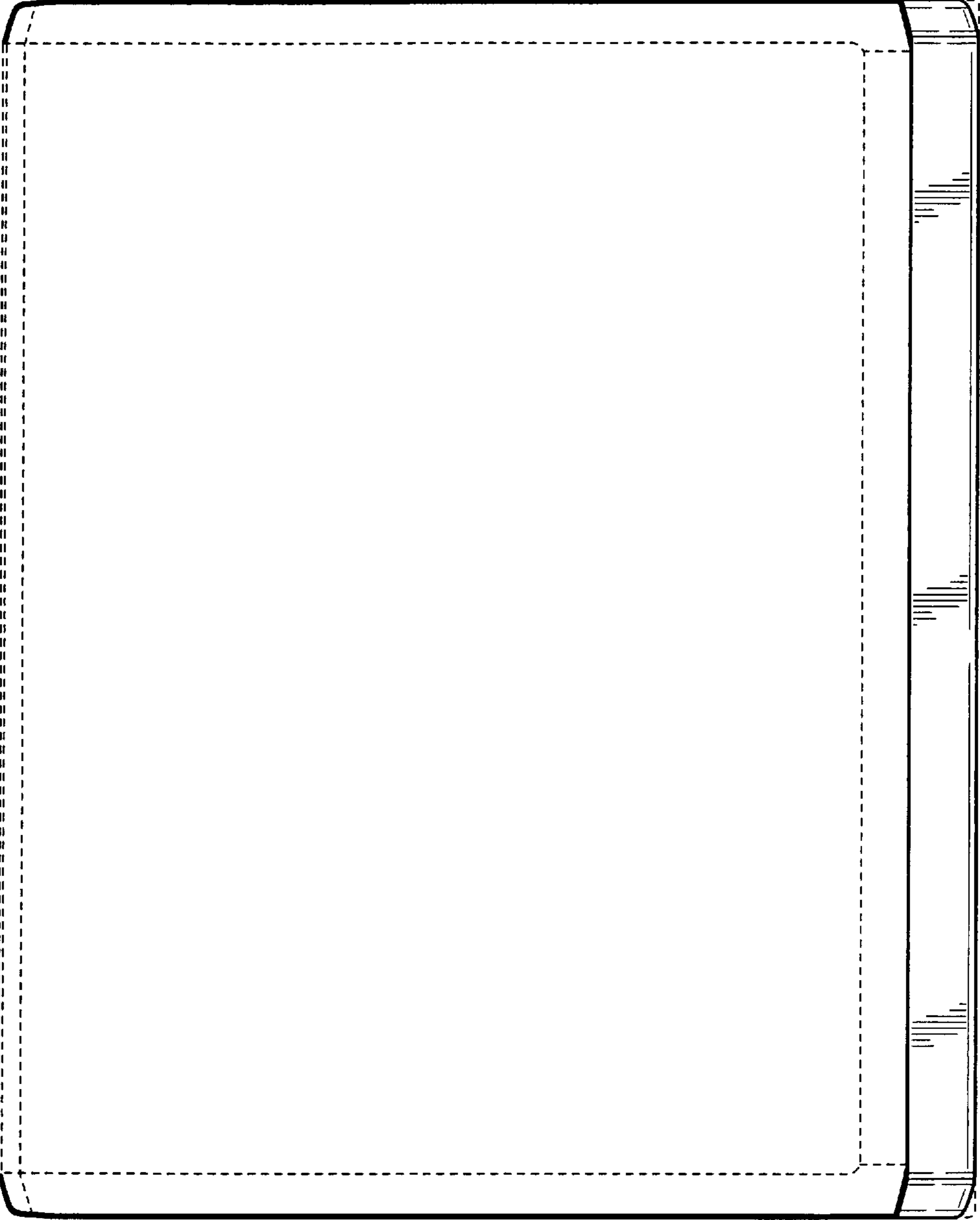

FIG. 6

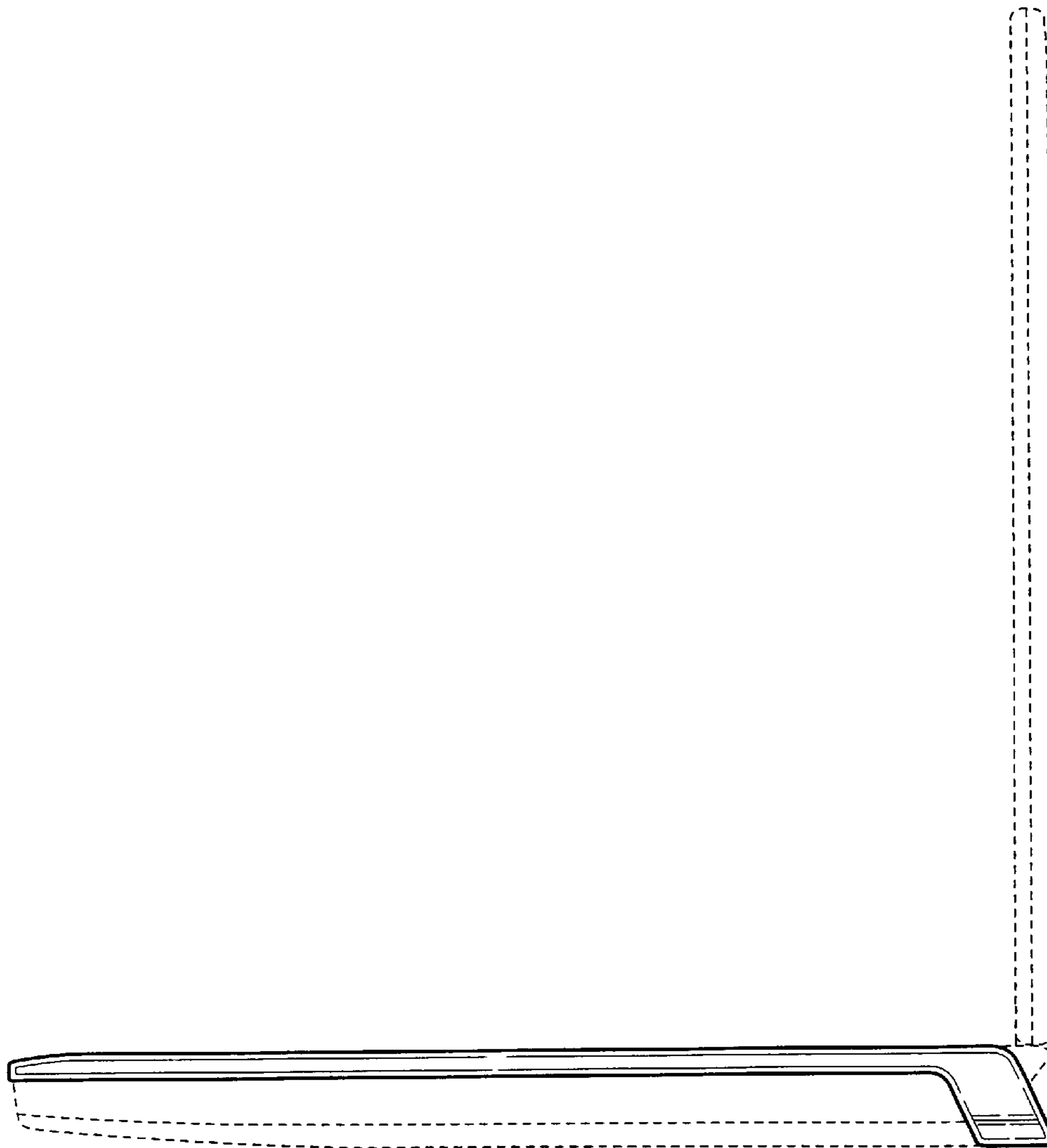

FIG. 7

