



US00D515063S

(12) **United States Design Patent** (10) **Patent No.:** **US D515,063 S**
Yanagisawa et al. (45) **Date of Patent:** **** Feb. 14, 2006**

(54) **TELEPHONE SET**
 (75) Inventors: **Keigo Yanagisawa**, Tokyo (JP);
Teruaki Takigawa, Tokyo (JP); **Syohei Suzuki**, Tokyo (JP)
 (73) Assignee: **Iwatsu Electric Co., Ltd.**, Tokyo (JP)
 (**) Term: **14 Years**

D410,648 S * 6/1999 Zeitman D14/151
 D472,540 S * 4/2003 Katou D14/151
 D481,701 S * 11/2003 Kamezawa et al. D14/151
 D489,700 S * 5/2004 Hillenmayer D14/151
 D490,394 S * 5/2004 Taniguchi et al. D14/151
 D499,079 S * 11/2004 Abe et al. D14/151
 D499,713 S * 12/2004 Shibata et al. D14/151
 2004/0247113 A1 * 12/2004 Akatsu 379/419

FOREIGN PATENT DOCUMENTS

JP 979140 * 4/1997

(21) Appl. No.: **29/220,292**
 (22) Filed: **Dec. 28, 2004**

OTHER PUBLICATIONS

(51) **LOC (8) Cl.** **14-03**
 (52) **U.S. Cl.** **D14/151**
 (58) **Field of Classification Search** D14/149–151,
 D14/147–148, 251–253, 144, 143, 130, 329,
 D14/330, 434, 140, 142; 379/419, 428.01–428.04,
 379/440; D13/107, 108; D21/517
 See application file for complete search history.

Yanagisawa, Keigo et al., “Telephone Set”, Advance Design—WG, Iwatsu Electric Co., Ltd., Apr. 15, 2004, 10 pages.

Yanagisawa, Keigo et al., “Telephone Set”, Telenetwork of the Future Telmage, Iwatsu Electric Co., Ltd., Nov. 2004, pp. 7 and 8.

* cited by examiner

(56) **References Cited**

U.S. PATENT DOCUMENTS

D276,338 S * 11/1984 Pardo D14/144
 D298,936 S * 12/1988 Ohta et al. D14/151
 D303,386 S * 9/1989 Iino D14/142
 D303,390 S * 9/1989 Ohta et al. D14/151
 D312,459 S * 11/1990 Oshima et al. D14/151
 D319,054 S * 8/1991 Appleby D14/151
 D319,642 S * 9/1991 Ando D14/151
 D321,872 S * 11/1991 Ando D14/151
 D342,247 S * 12/1993 Desbarats D14/130
 D344,517 S * 2/1994 Toh et al. D14/151
 D345,557 S * 3/1994 Akatsu et al. D14/151
 D348,670 S * 7/1994 Yoneyama D14/151
 D354,956 S * 1/1995 Toh et al. D14/151
 5,412,417 A * 5/1995 Tozuka 348/14.01
 D375,093 S * 10/1996 Babbitt et al. D14/151
 D387,056 S * 12/1997 Yoneyama D14/151
 D406,842 S * 3/1999 Zeitman D14/151

Primary Examiner—Jeffrey Asch

(74) *Attorney, Agent, or Firm*—Foley & Lardner LLP

(57) **CLAIM**

The ornamental design for a telephone set, as shown and described.

DESCRIPTION

FIG. 1 is a front perspective view of a telephone set showing our new design;
 FIG. 2 is a front view thereof;
 FIG. 3 is a top plan view thereof;
 FIG. 4 is a right side elevational view thereof;
 FIG. 5 is a left side elevational view thereof;
 FIG. 6 is a rear view thereof; and,
 FIG. 7 is a bottom plan view thereof.

1 Claim, 4 Drawing Sheets

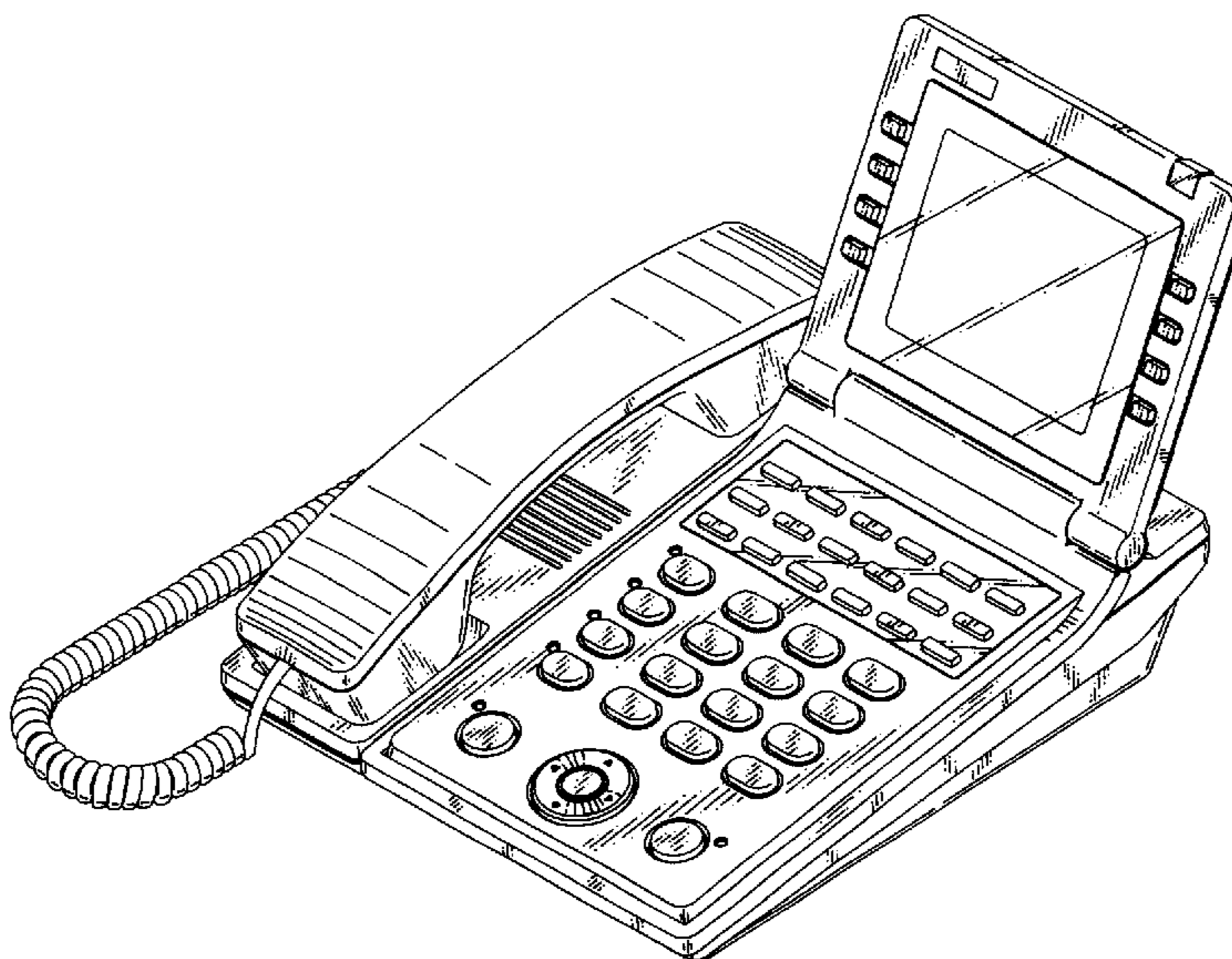

Fig. 1

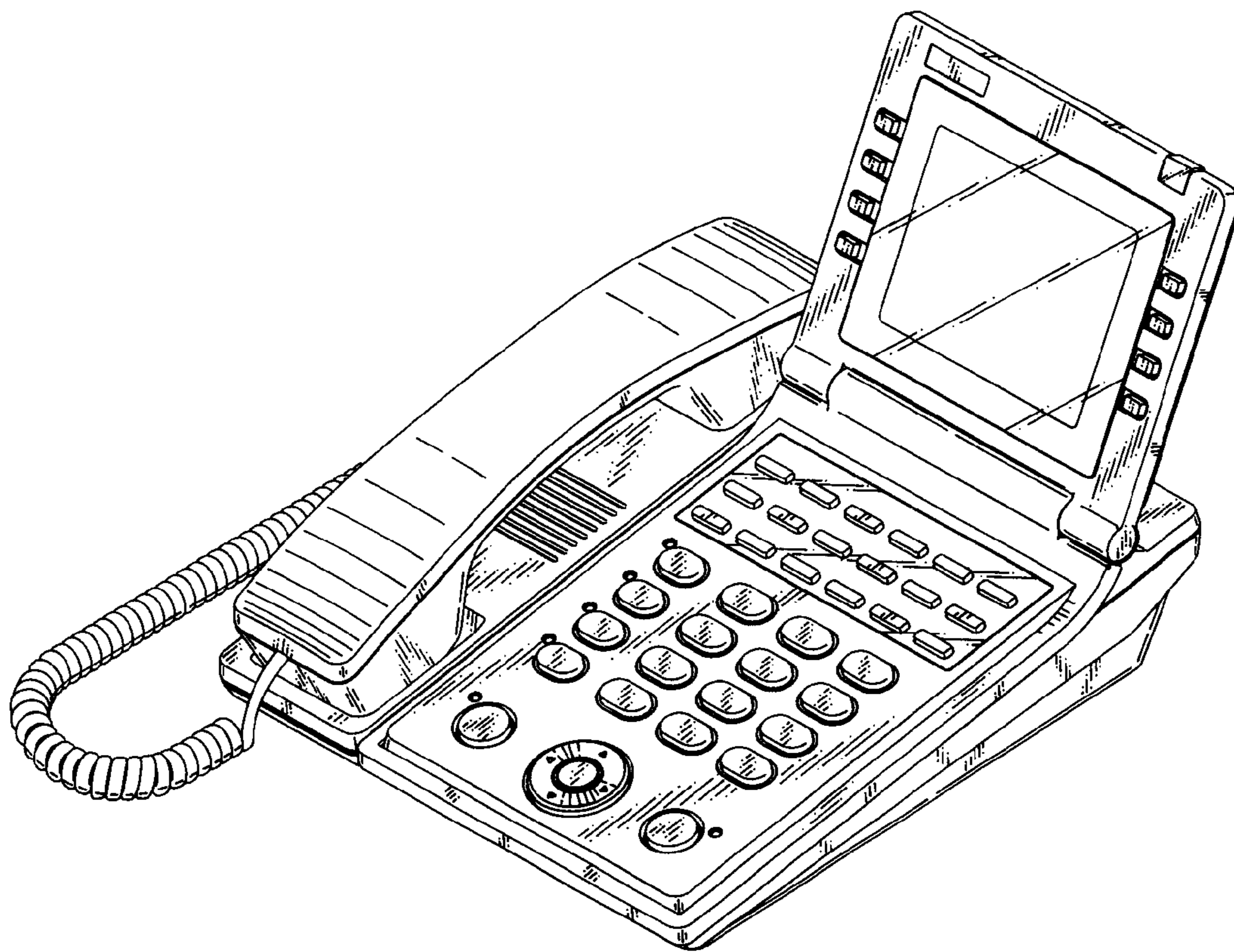

Fig.2

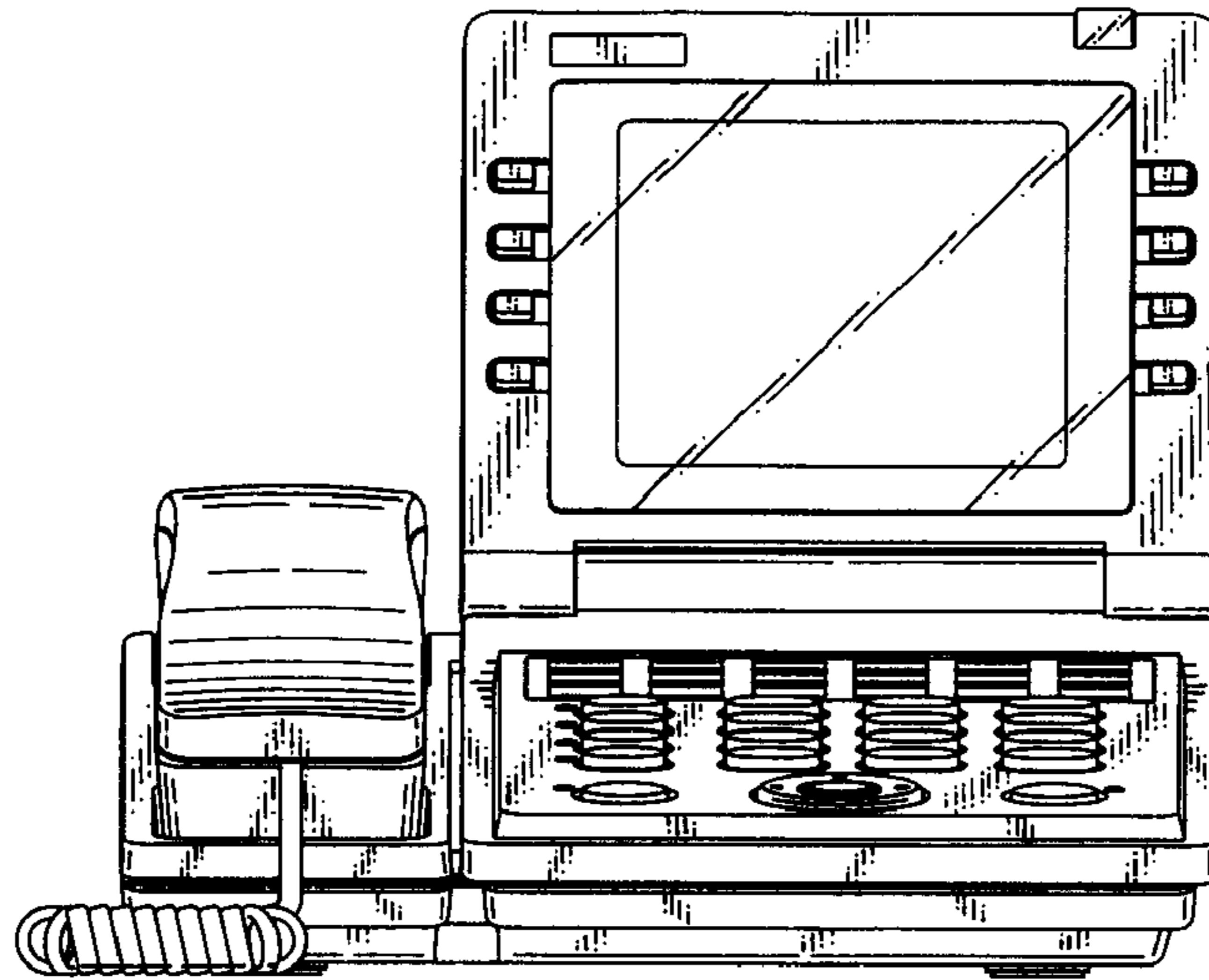

Fig.3

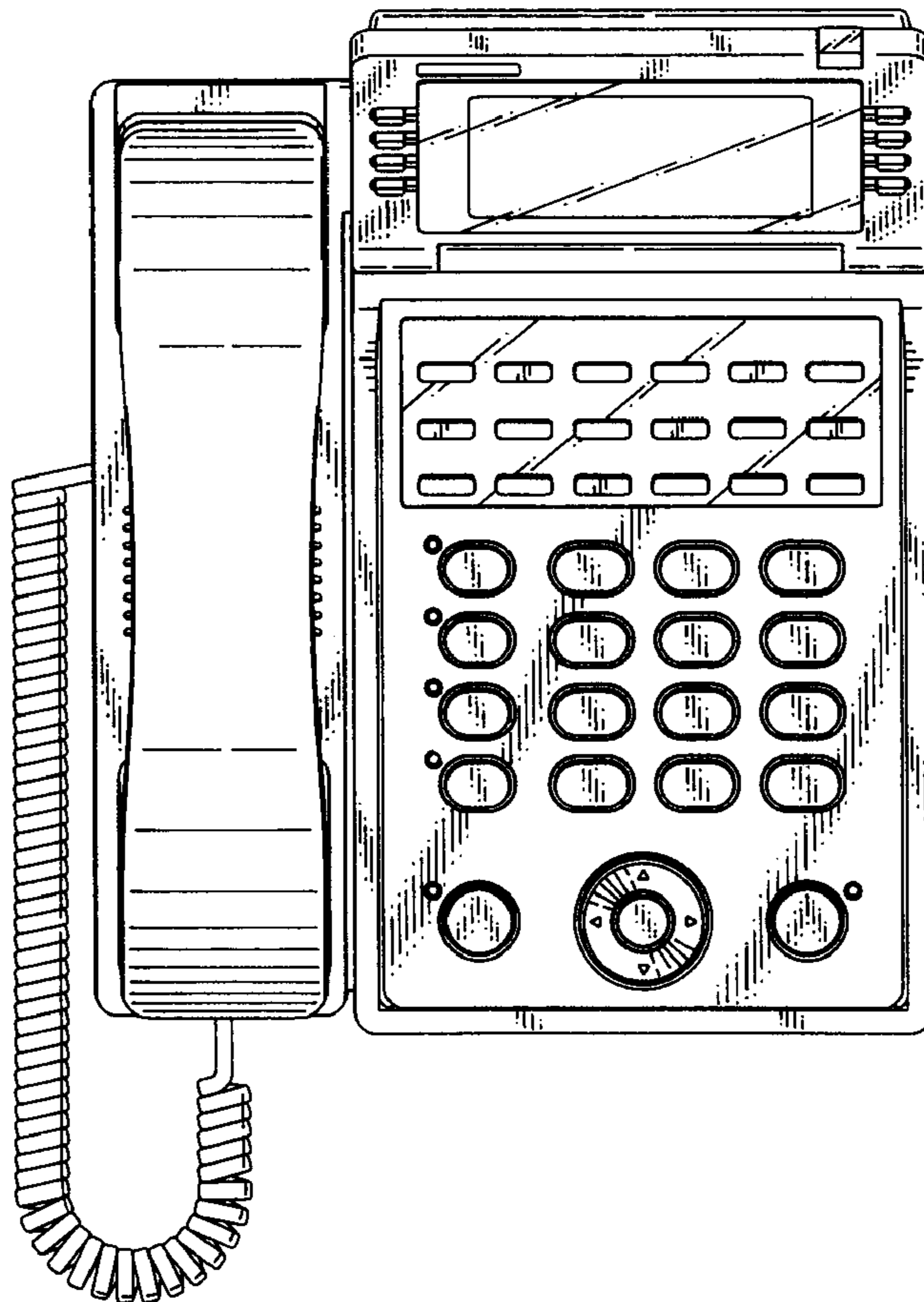

Fig.4

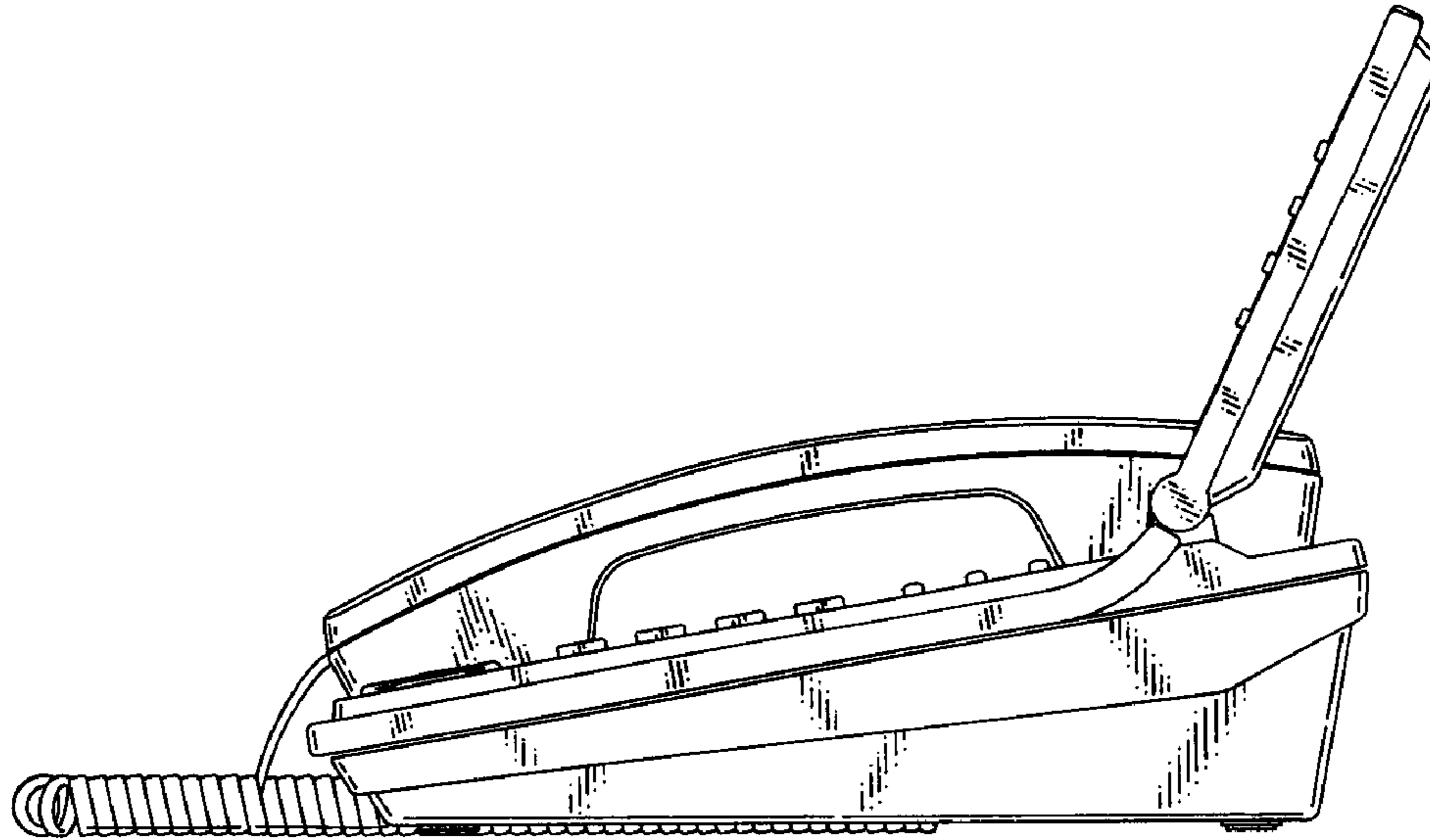

Fig.5

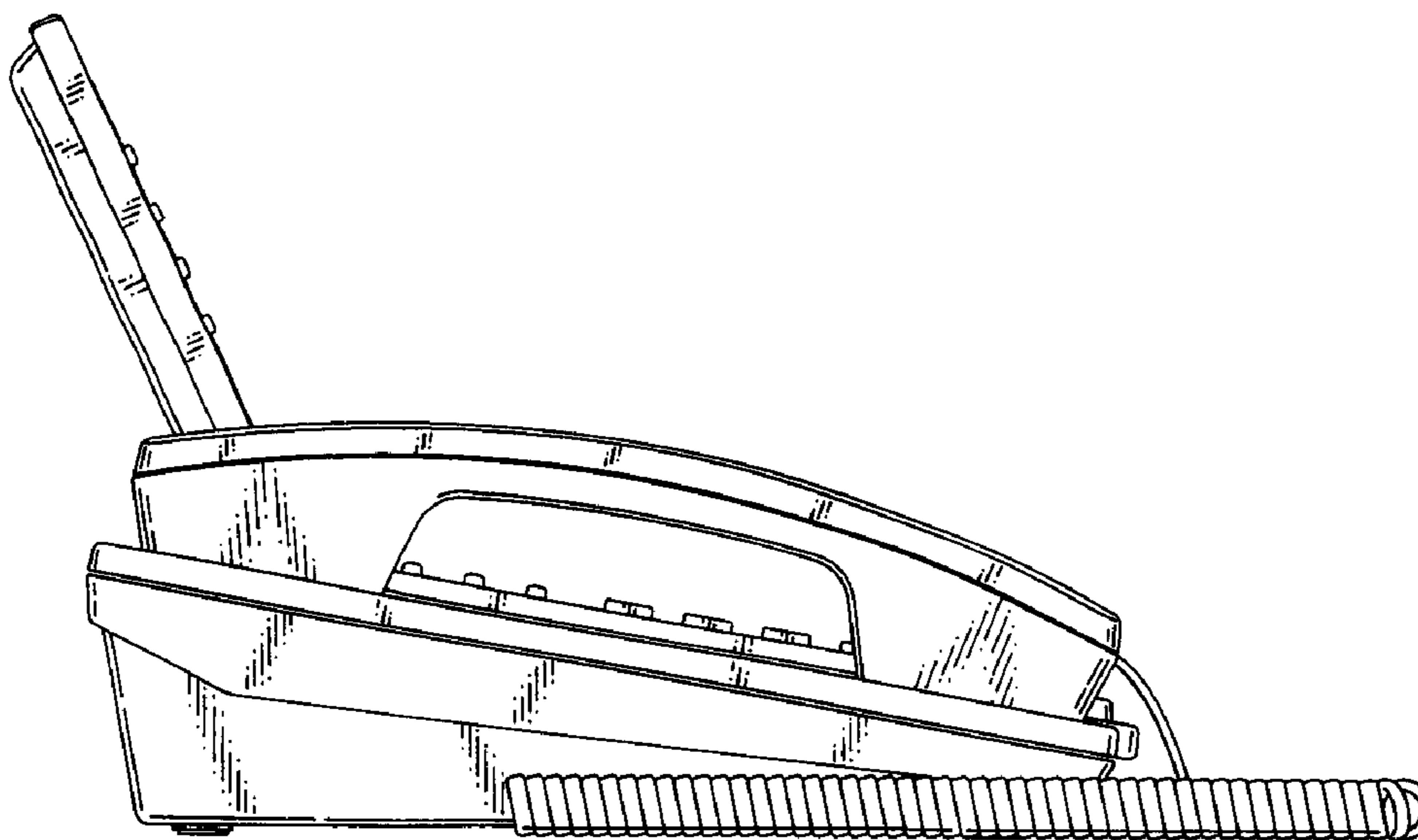

Fig.6

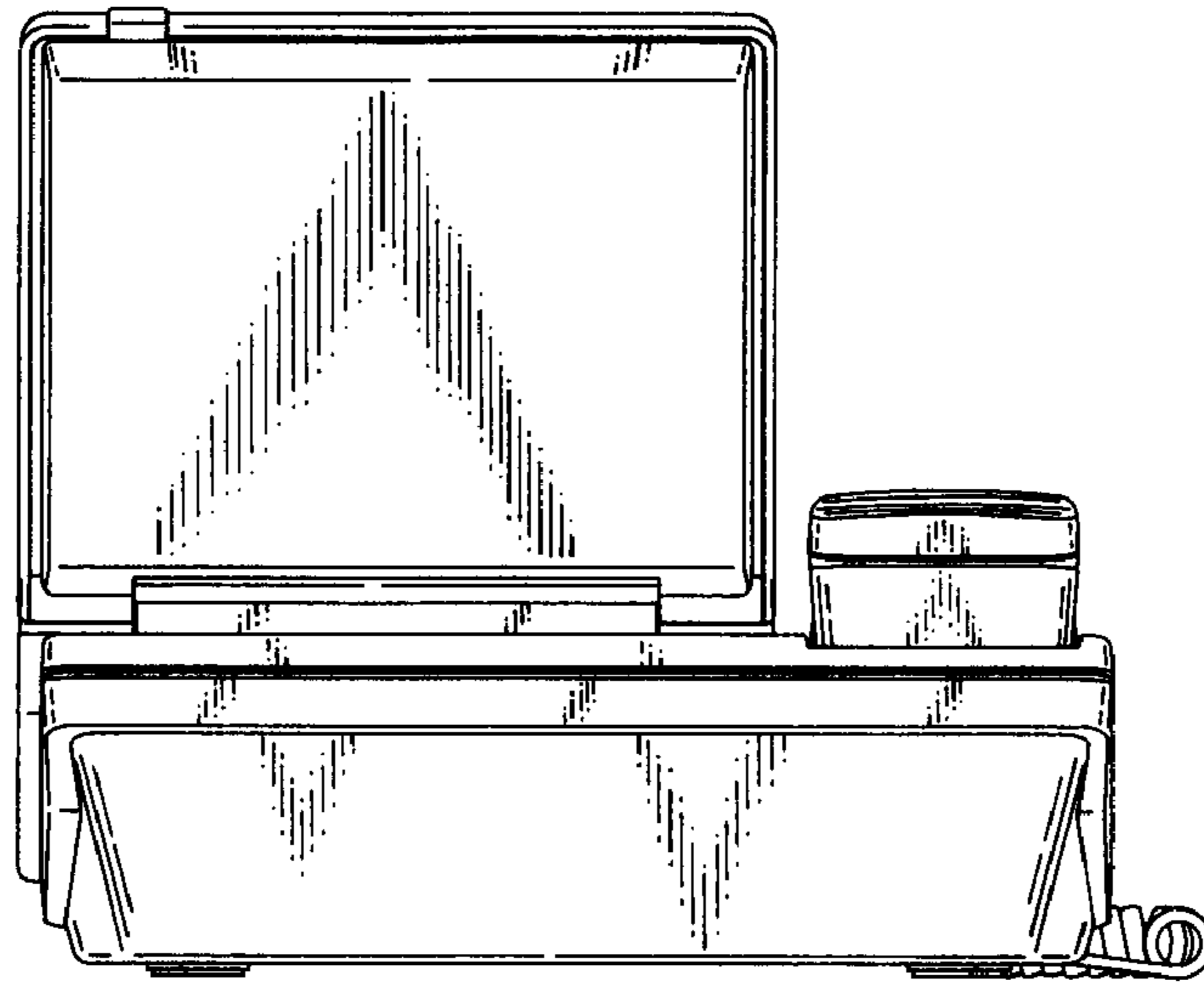

Fig.7

