



US00D515060S

(12) **United States Design Patent** (10) **Patent No.:** **US D515,060 S**
Lee et al. (45) **Date of Patent:** **** Feb. 14, 2006**

(54) **CELLULAR PHONE**

(75) Inventors: **Min-Hyouk Lee**, Suwon-si (KR);
Chang-Hwan Hwang, Goyang-si (KR)

(73) Assignee: **Samsung Electronics Co., Ltd.** (KR)

(**) Term: **14 Years**

(21) Appl. No.: **29/214,451**

(22) Filed: **Oct. 1, 2004**

(30) **Foreign Application Priority Data**

Apr. 1, 2004 (KR) 30-2004-0009314

(51) **LOC (8) Cl.** **14-03**

(52) **U.S. Cl.** **D14/138**

(58) **Field of Classification Search** D14/137,
D14/138, 147-148, 247-248, 144, 341-347;
379/433.01-433.13, 434; 455/550.1-90.3,
455/575.4, 566, 575.1, 556.1, 556.2, 575.6;
D21/517; 345/169

See application file for complete search history.

(56) **References Cited**

U.S. PATENT DOCUMENTS

- D423,493 S * 4/2000 Hakoda D14/138
- D425,887 S * 5/2000 Edwards et al. D14/138
- D466,096 S * 11/2002 Takada D14/138
- D479,215 S * 9/2003 Yokoyama D14/138
- D481,692 S * 11/2003 Husgafvel D14/138
- D484,503 S * 12/2003 Duarte et al. D14/346
- D485,819 S * 1/2004 Ahlgren D14/138
- D487,438 S * 3/2004 Sheu D14/138
- D488,468 S * 4/2004 Hu D14/341
- D488,789 S * 4/2004 Lee D14/138
- D493,156 S * 7/2004 Hamann et al. D14/138
- D494,950 S * 8/2004 Keunecke D14/138
- D495,310 S * 8/2004 Husgafvel D14/138
- D495,695 S * 9/2004 Yugaya D14/346
- D496,644 S * 9/2004 Yoo et al. D14/138
- D496,645 S * 9/2004 Yoo et al. D14/138
- D496,921 S * 10/2004 Hwang D14/138
- D497,602 S * 10/2004 Huff D14/138
- D498,736 S * 11/2004 Lee D14/138

- 6,822,871 B1 * 11/2004 Lee et al. 361/727
- D501,475 S * 2/2005 Kim D14/346
- D502,162 S * 2/2005 Kim et al. D14/138
- 2003/0064688 A1 * 4/2003 Mizuta et al. 455/90
- 2004/0198458 A1 * 10/2004 Kawamura 455/566
- 2004/0259592 A1 * 12/2004 Taneya et al. 455/556.1
- 2004/0266477 A1 * 12/2004 Murata 455/556.1
- 2005/0009581 A1 * 1/2005 Im et al. 455/575.4
- 2005/0014527 A1 * 1/2005 Chambers et al. 455/556.1
- 2005/0020327 A1 * 1/2005 Chung et al. 455/575.3

FOREIGN PATENT DOCUMENTS

- JP 1088577 * 10/2000
- JP 1160810 * 12/2002
- JP 2003298699 A * 10/2003

OTHER PUBLICATIONS

NTTDoCoMo SO505i, © 2003, showings from NTT DoCoMo visited Apr. 10, 2003 and www.mobileburn.com visited Sep. 28, 2004.*

www.mobiletechnews.com visited Mar. 3, 2005, Samsung SGH-D500 phone, article posted Oct. 11, 2004.*

* cited by examiner

Primary Examiner—Jeffrey Asch

(74) *Attorney, Agent, or Firm*—Cantor Colburn LLP

(57) **CLAIM**

We claim, the ornamental design for a cellular phone, as shown and described.

DESCRIPTION

FIG. 1 is a top and front perspective view of a cellular phone, showing our new design;
 FIG. 2 is a front elevational view thereof;
 FIG. 3 is a rear elevational view thereof;
 FIG. 4 is a top elevational view thereof;
 FIG. 5 is a bottom elevational view thereof;
 FIG. 6 is a left side view thereof;
 FIG. 7 is a right side view thereof; and,
 FIG. 8 is a front perspective view thereof, the cellular phone being in an alternate position.

1 Claim, 5 Drawing Sheets

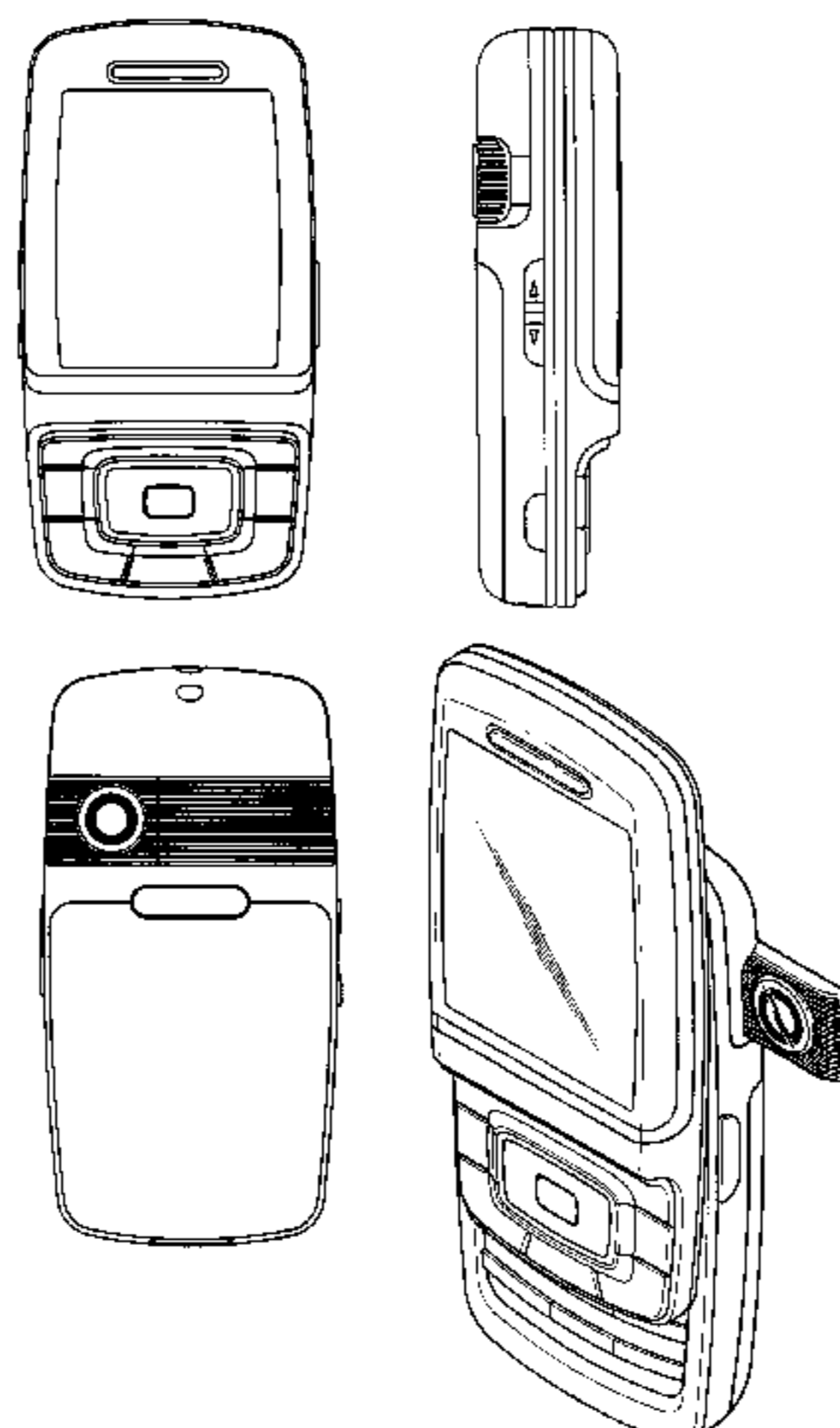

FIG. 1

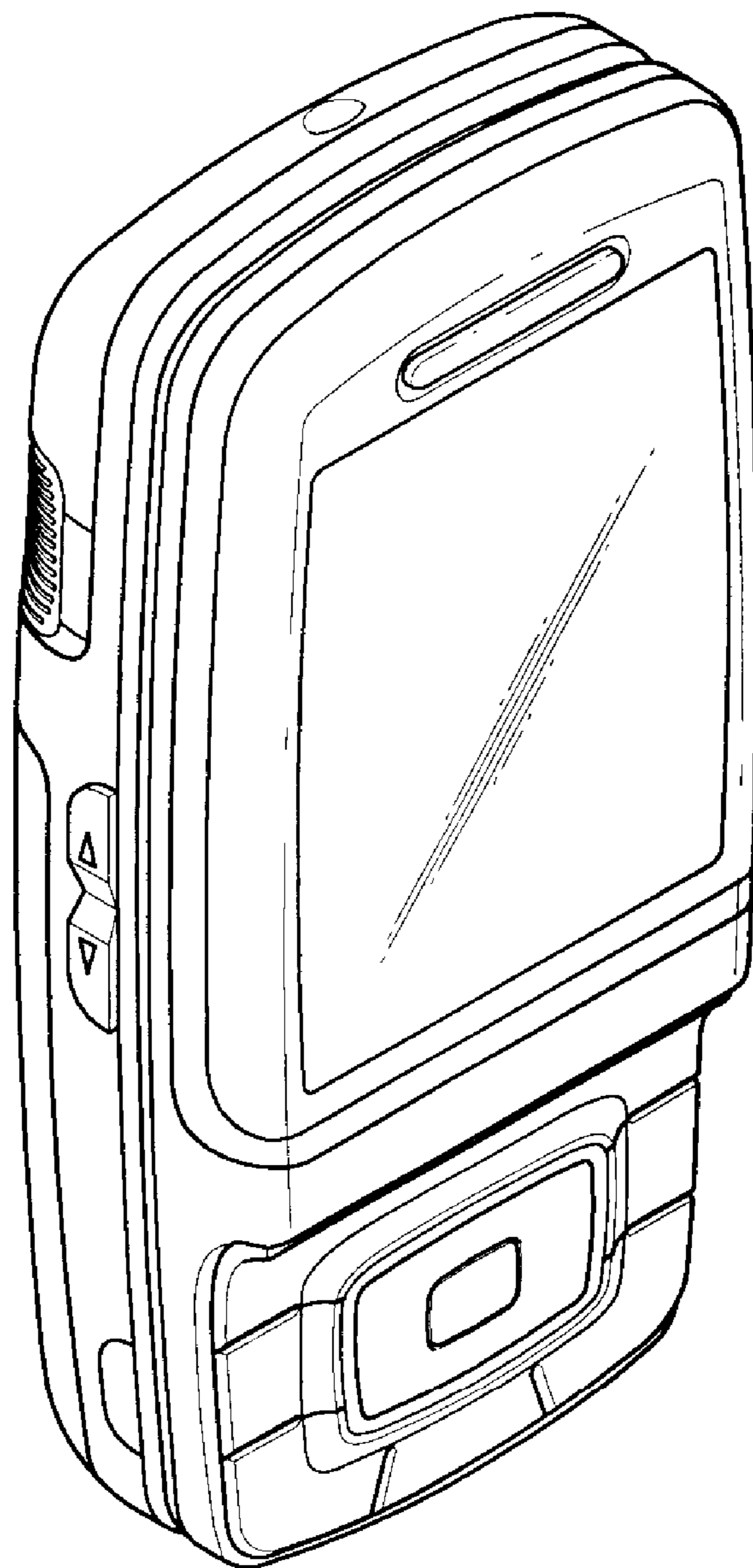

FIG. 2

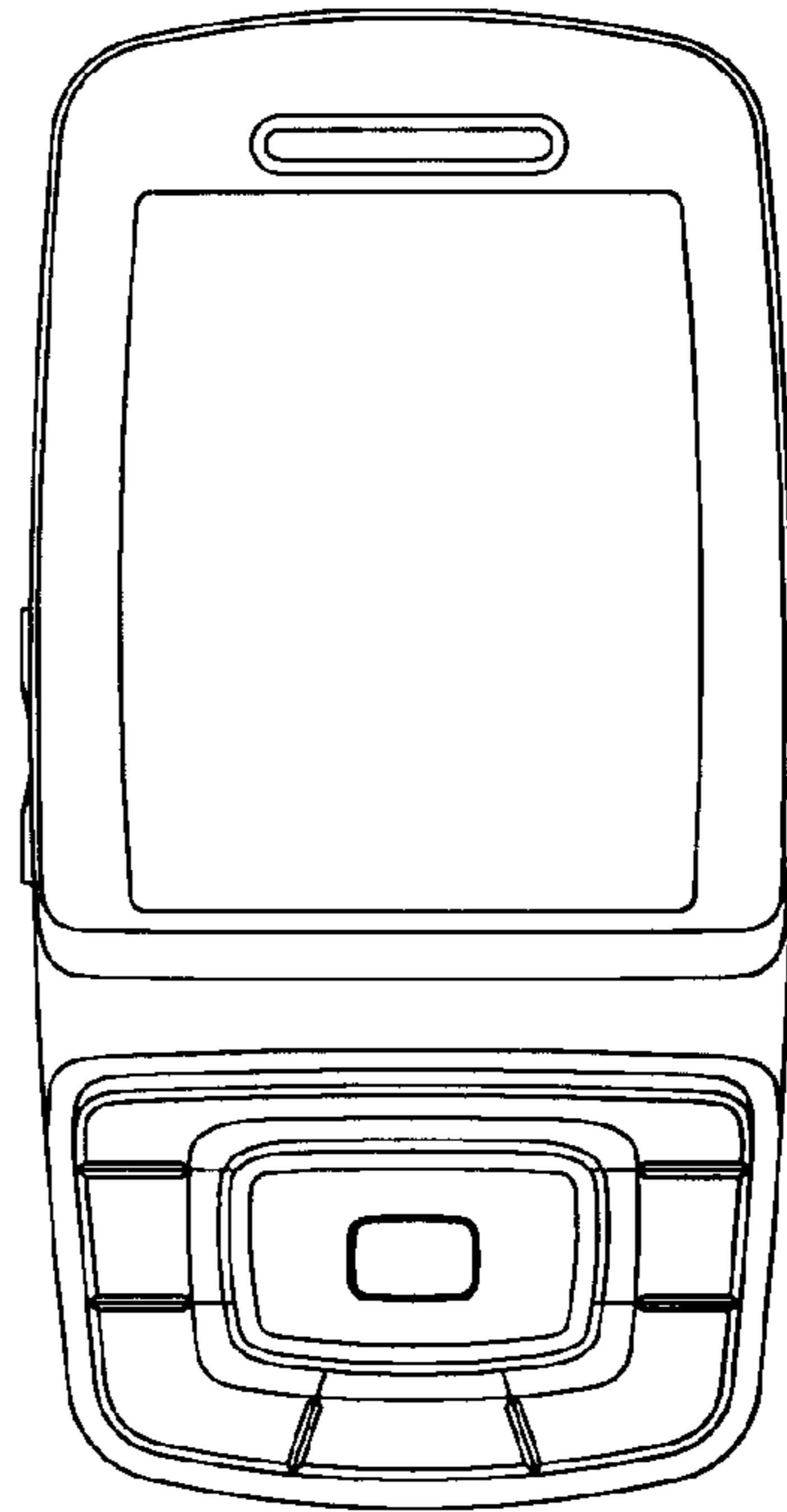

FIG. 3

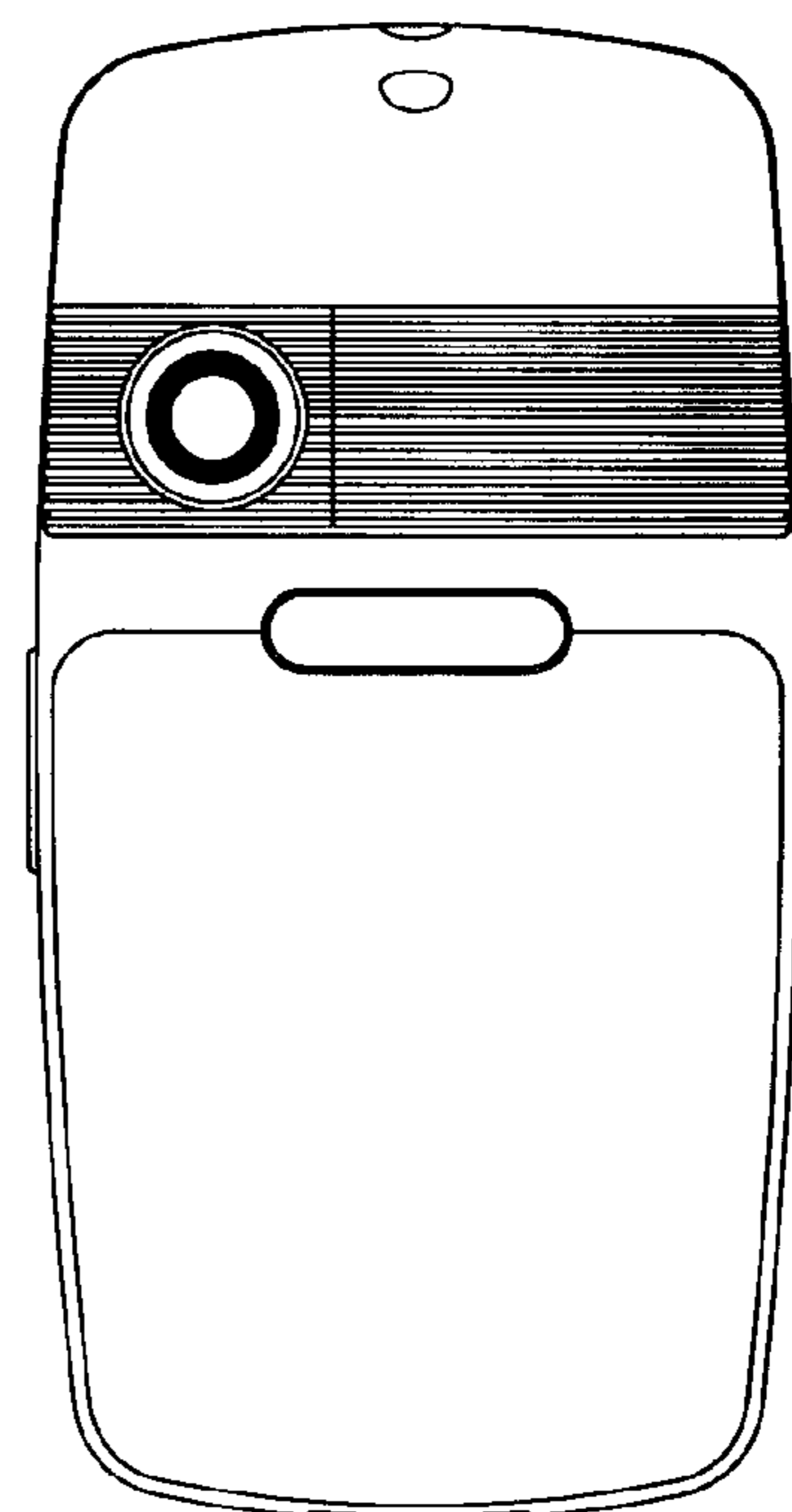

FIG. 4

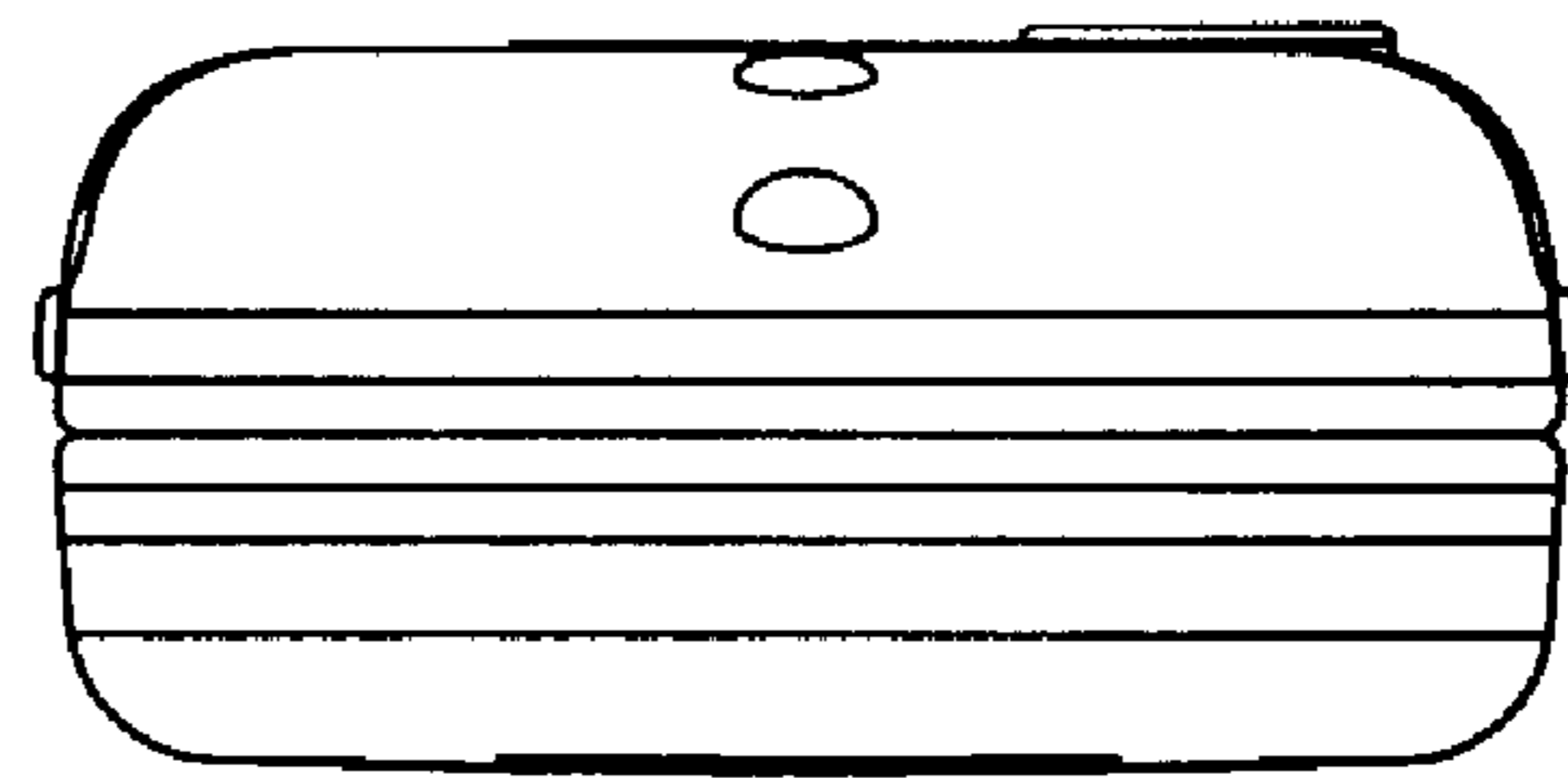

FIG. 5

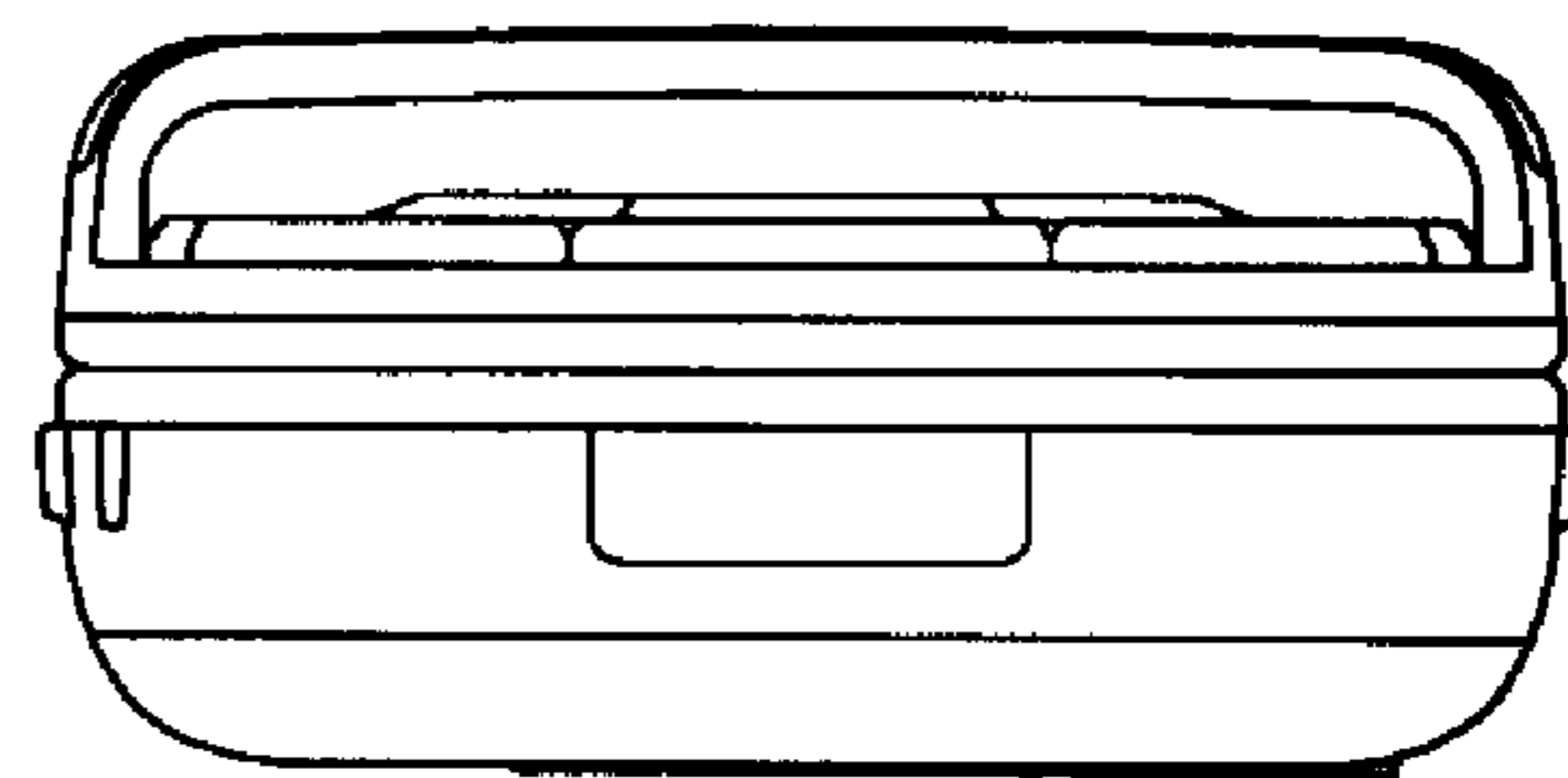

FIG. 6

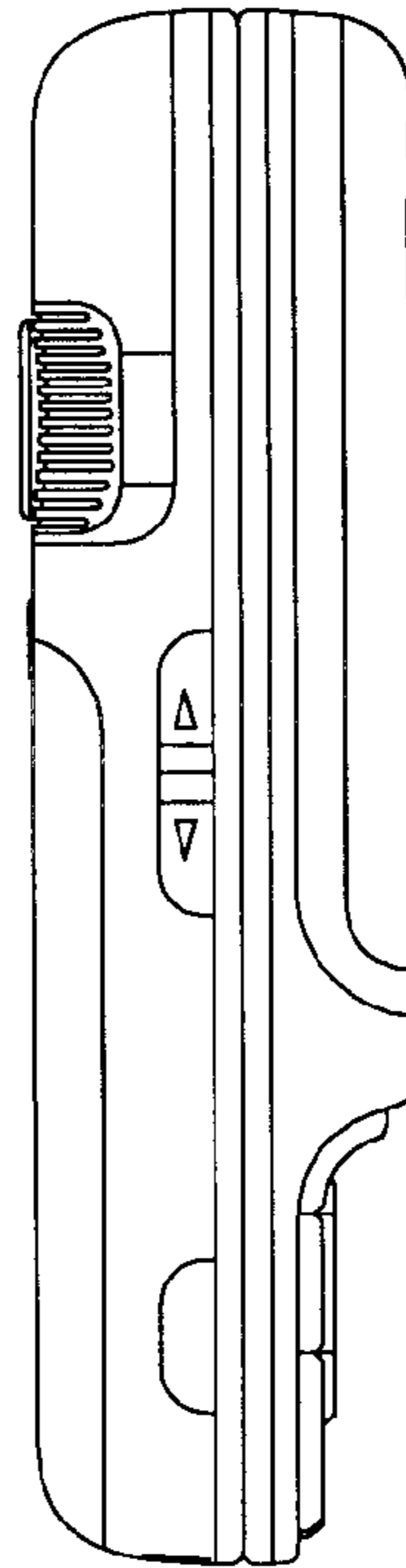

FIG. 7

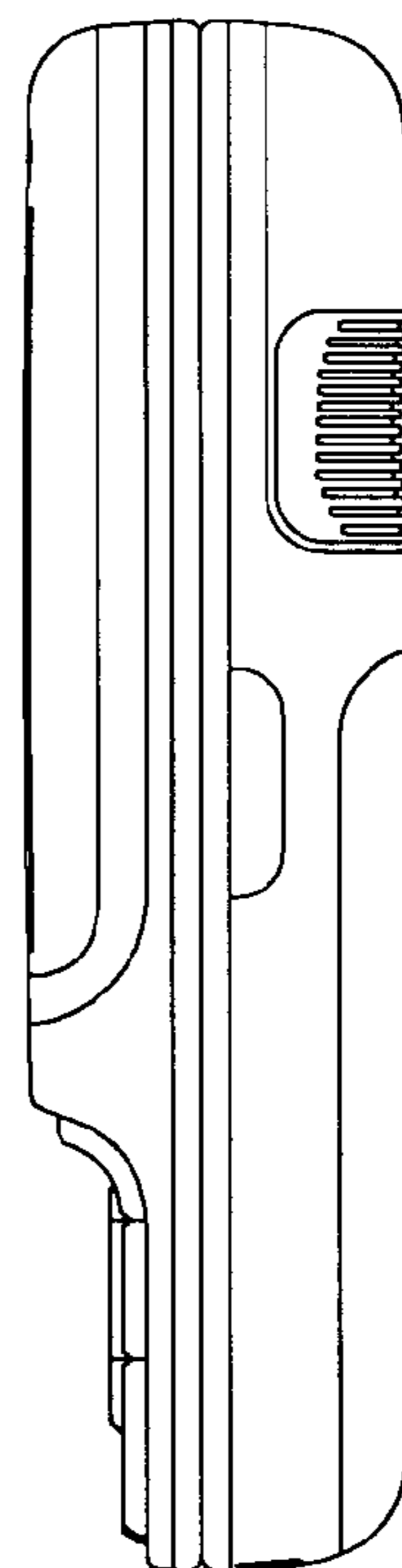

FIG. 8

