



US00D514918S

(12) **United States Design Patent** (10) **Patent No.:** **US D514,918 S**
Czerwinski (45) **Date of Patent:** **** Feb. 14, 2006**

- (54) **ANTI-VANDAL DOOR TRIM**
 (75) Inventor: **Frank Czerwinski**, Berlin, CT (US)
 (73) Assignee: **Sargent Manufacturing Company**,
 New Haven, CT (US)
 (**) Term: **14 Years**

5,131,189 A	7/1992	Mascotte	
D354,670 S	1/1995	Simon et al.	D8/353
D375,671 S	11/1996	Heithe	D8/346
D417,833 S	12/1999	Heithe	D8/346
6,327,878 B1	12/2001	Levenson	70/416
D458,528 S	6/2002	Simon et al.	D8/313
D462,252 S	9/2002	Simon et al.	D8/314
D474,101 S	5/2003	Simon et al.	D8/346

- (21) Appl. No.: **29/217,959**
 (22) Filed: **Nov. 23, 2004**

Related U.S. Application Data

- (62) Division of application No. 29/181,938, filed on May 14, 2003, now Pat. No. Des. 500,947.
 (51) **LOC (8) Cl.** **08-06**
 (52) **U.S. Cl.** **D8/314; D8/346**
 (58) **Field of Classification Search** D8/300,
 D8/313, 314, 346, 350; 70/416, 417, 424,
 70/452; 292/346, 340, 357
 See application file for complete search history.

(56) **References Cited**

U.S. PATENT DOCUMENTS

2,489,072 A	11/1949	Ausubel	
3,391,674 A	7/1968	Burleigh	
3,645,045 A	2/1972	Gervis et al.	
3,698,217 A	10/1972	Roy	
3,764,173 A	10/1973	Griffith	
3,815,945 A *	6/1974	Lamphere	292/340
3,888,530 A	6/1975	Fabrici	
D258,717 S *	3/1981	Williams	D8/346
4,484,463 A	11/1984	Hennessy	
4,583,776 A	4/1986	Bouchard	
4,751,834 A	6/1988	Beck	
4,802,701 A	2/1989	Mazie	
4,841,754 A	6/1989	Jones	

FOREIGN PATENT DOCUMENTS

FR 921069 4/1947

* cited by examiner

Primary Examiner—Adir Aronovich

(74) *Attorney, Agent, or Firm*—Delio & Peterson, LLC

(57) **CLAIM**

The ornamental design for an anti-vandal door trim, as shown and described.

DESCRIPTION

FIG. 1 is a front perspective view of a first embodiment an anti-vandal door trim showing my new design;
 FIG. 2 is a front elevational view thereof;
 FIG. 3 is a left side elevational view thereof;
 FIG. 4 is a rear elevational view thereof;
 FIG. 5 is a right side elevational view thereof;
 FIG. 6 top plan view thereof;
 FIG. 7 is a bottom plan view thereof;
 FIG. 8 is a front perspective view of a second embodiment of the anti-vandal door trim;
 FIG. 9 is a front elevational view thereof;
 FIG. 10 is left side elevational view thereof;
 FIG. 11 is a rear elevational view thereof;
 FIG. 12 is a right side elevational view thereof;
 FIG. 13 top plan view thereof; and,
 FIG. 14 is a bottom plan view thereof.

1 Claim, 4 Drawing Sheets

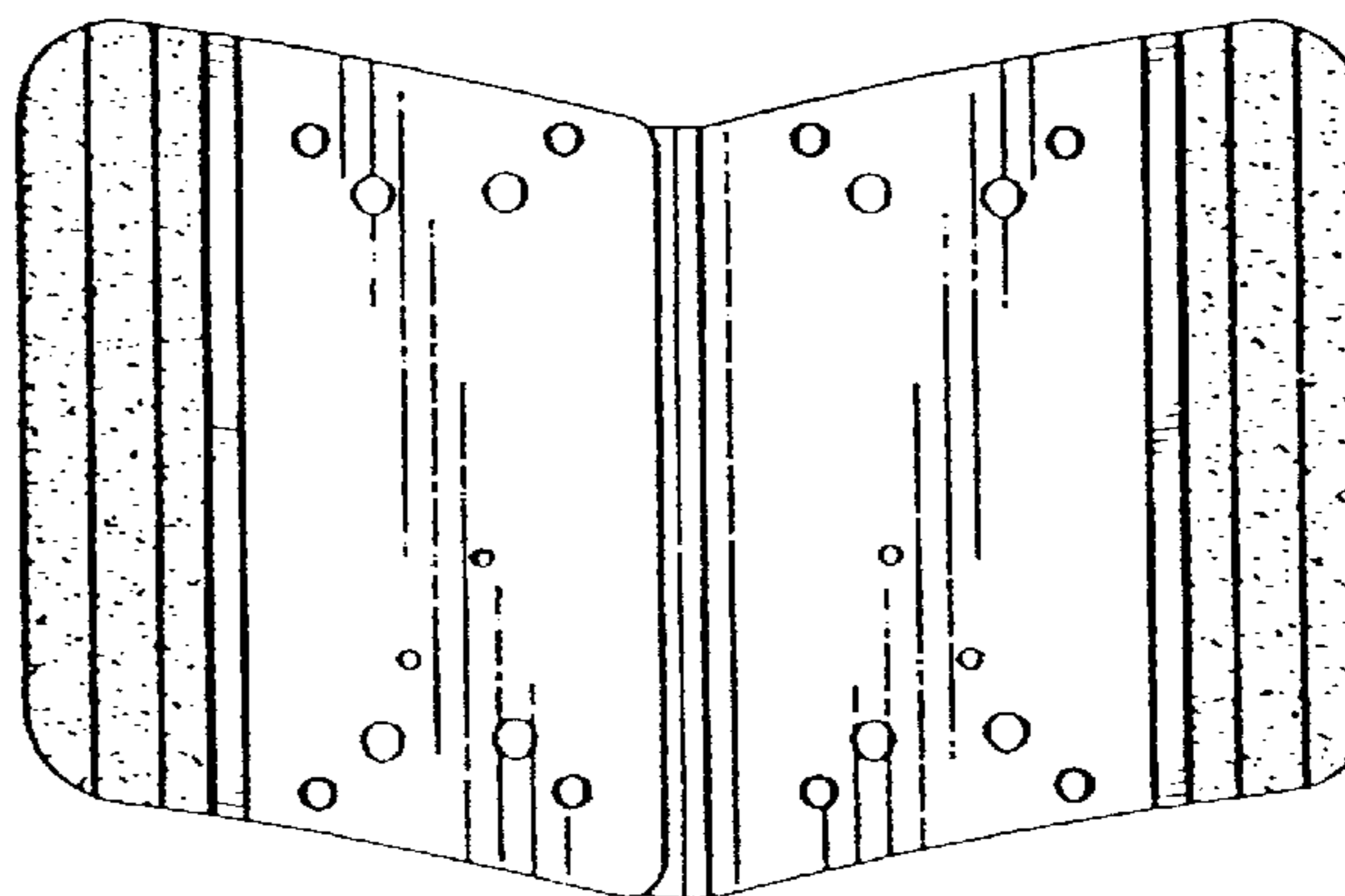
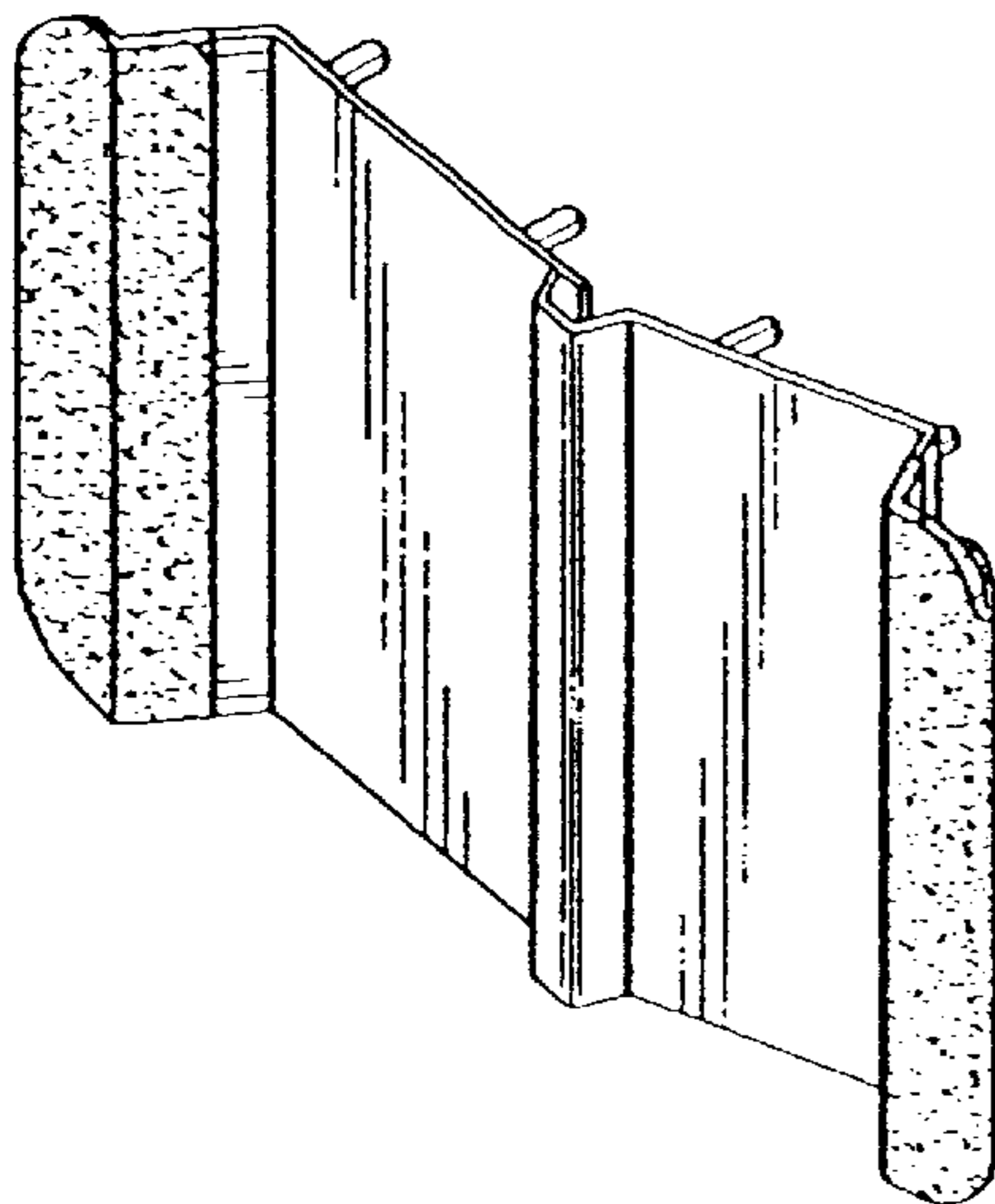

FIG. 1

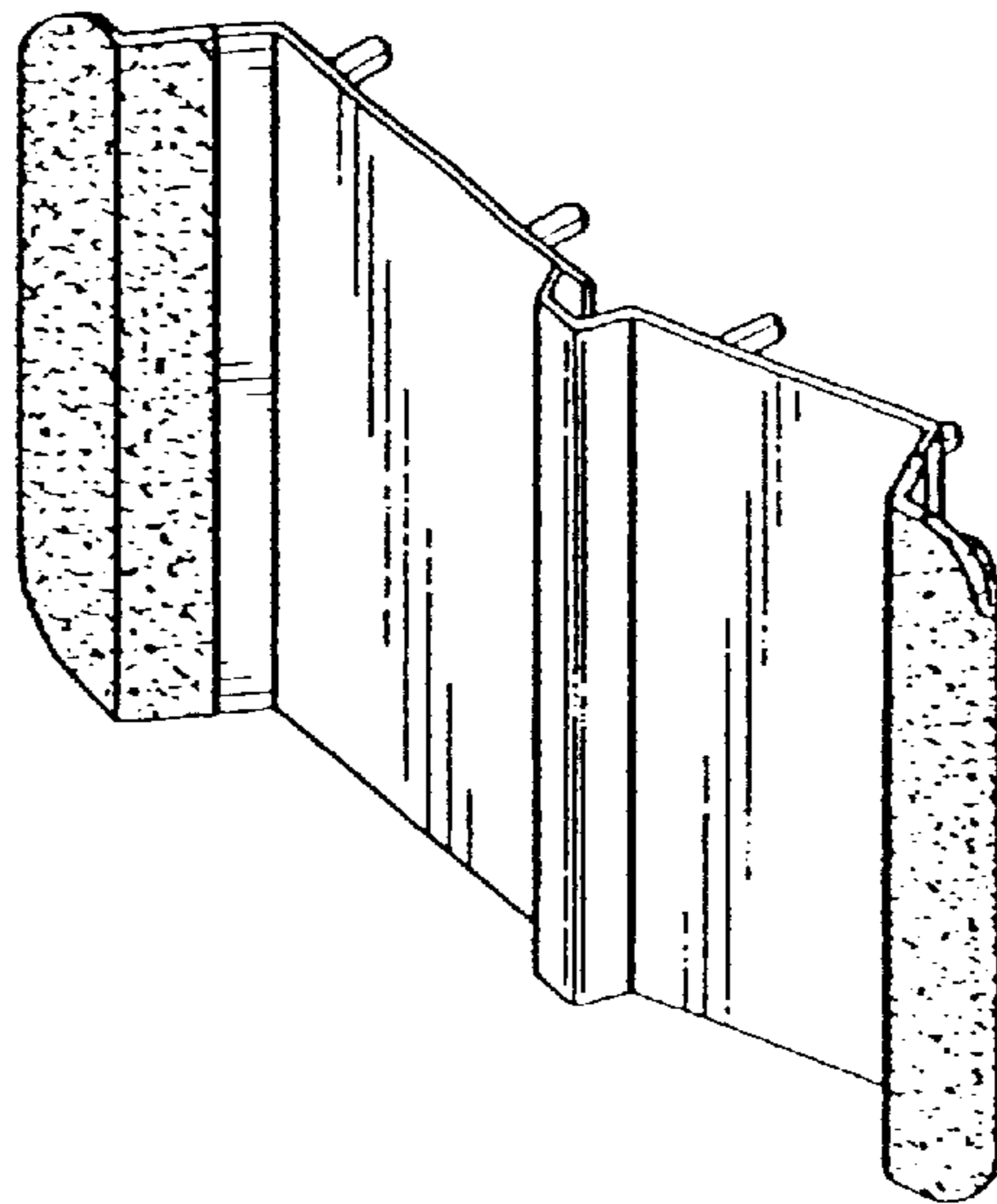

FIG. 2

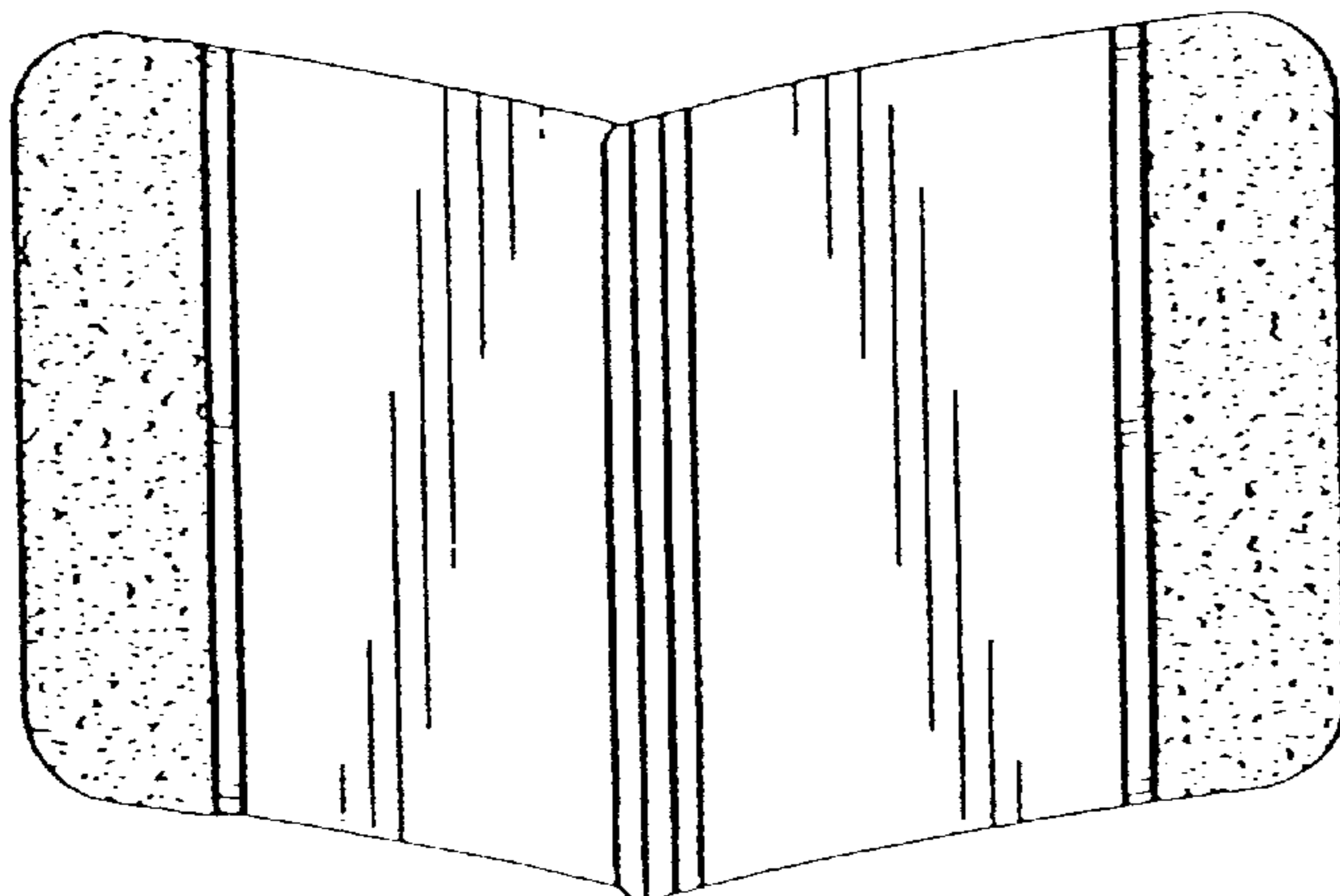

FIG. 3

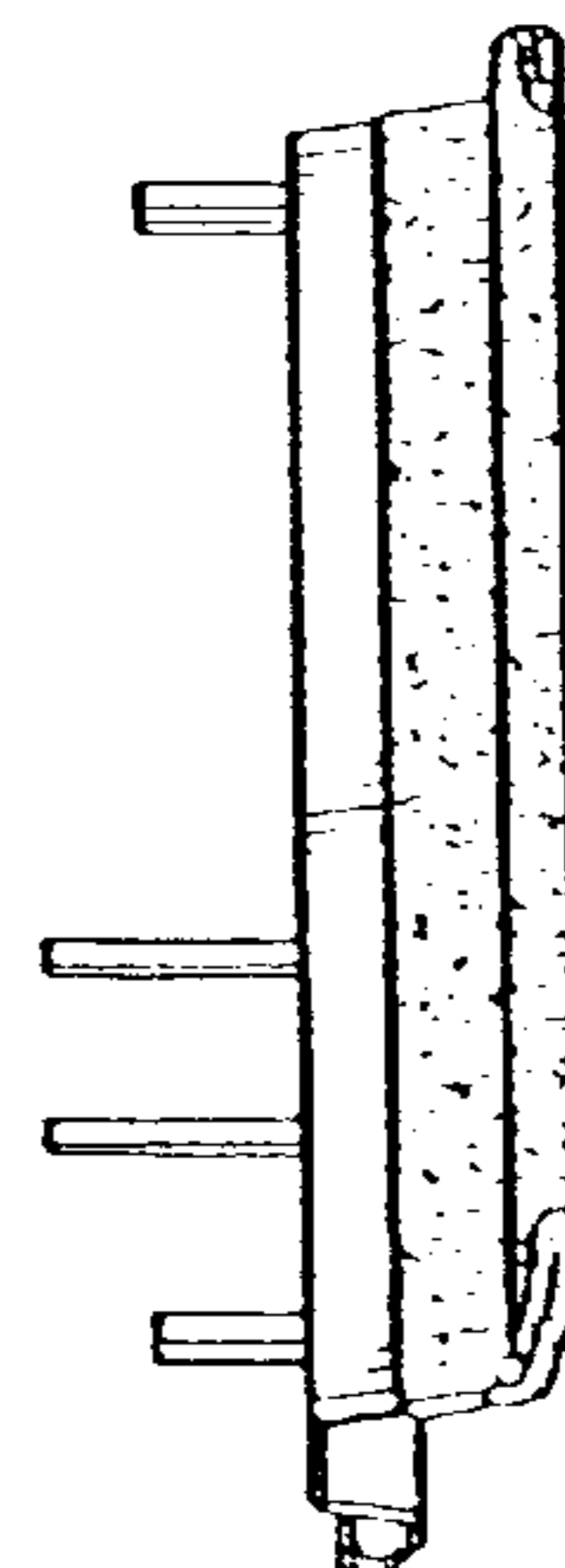

FIG.4

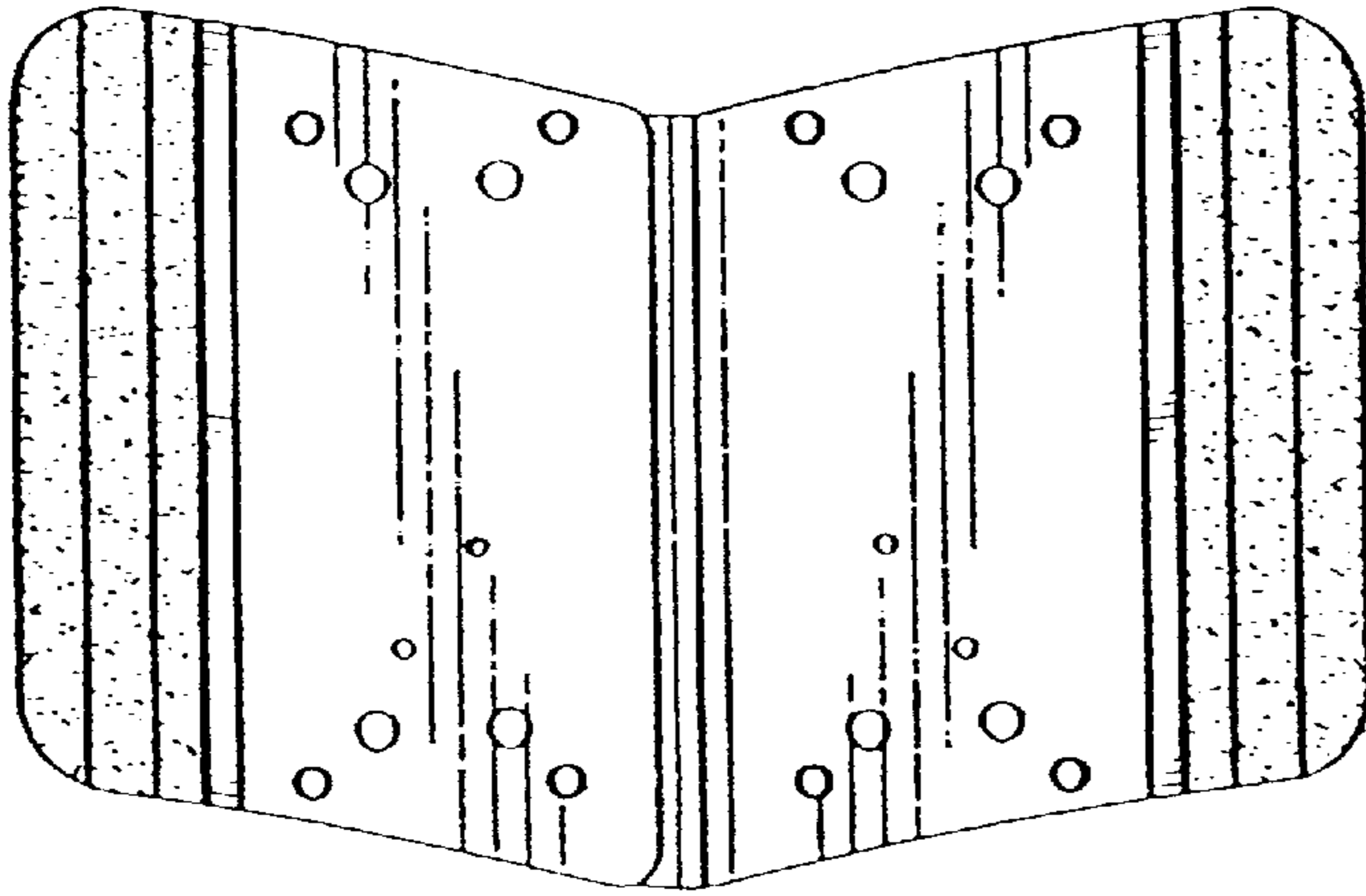

FIG.5

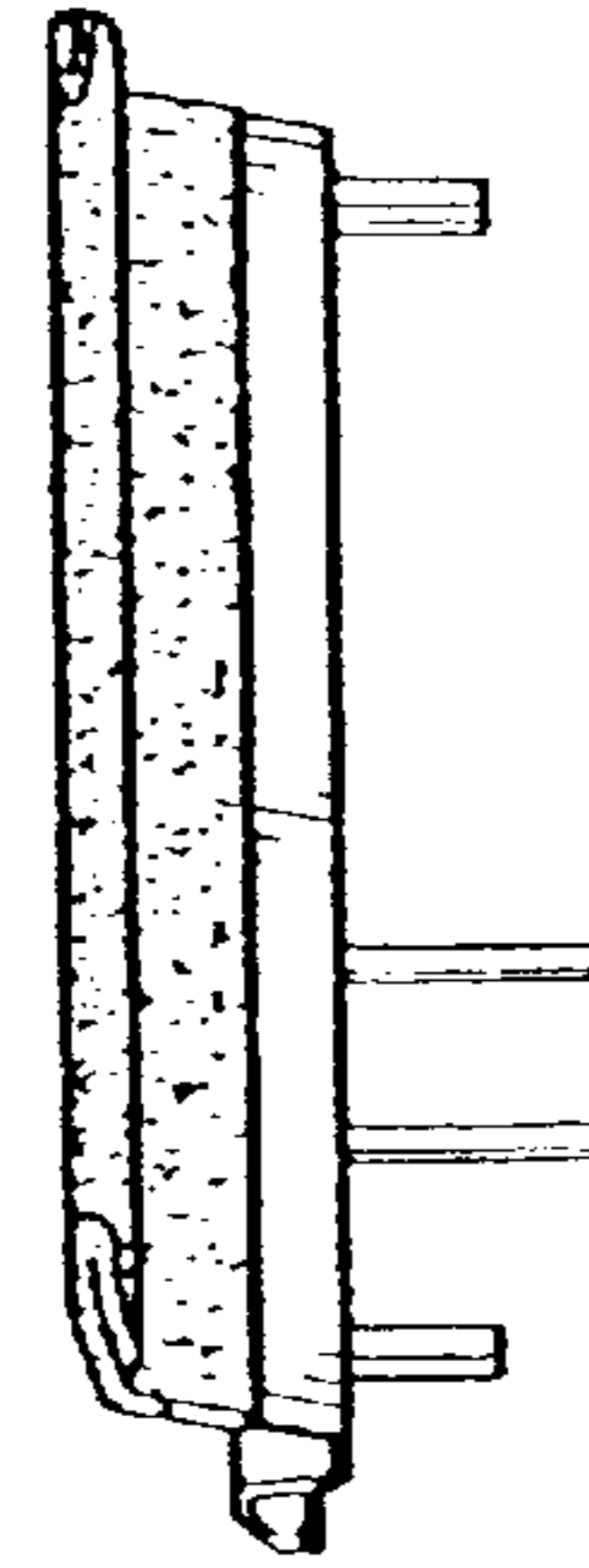

FIG.6

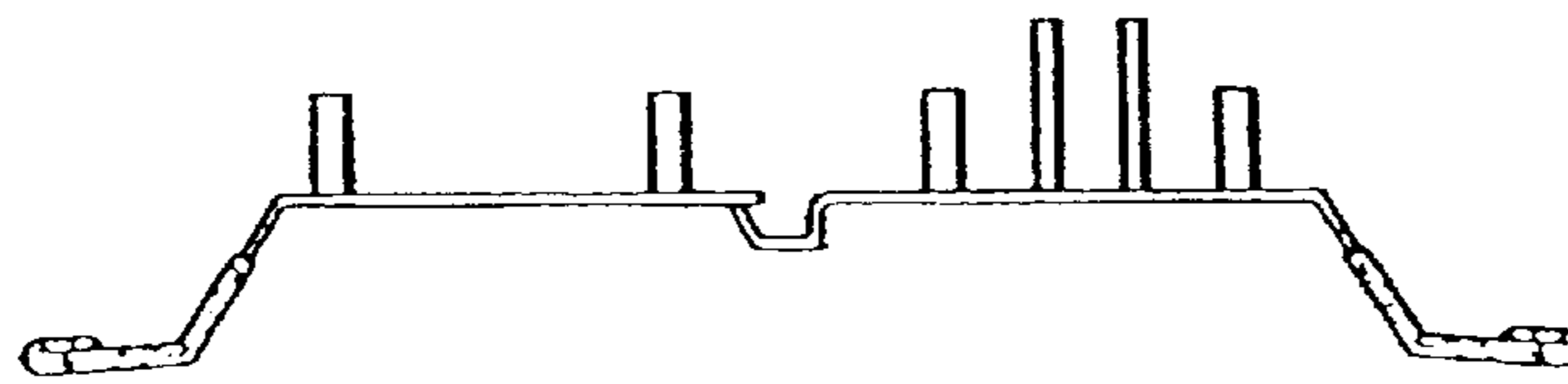

FIG.7

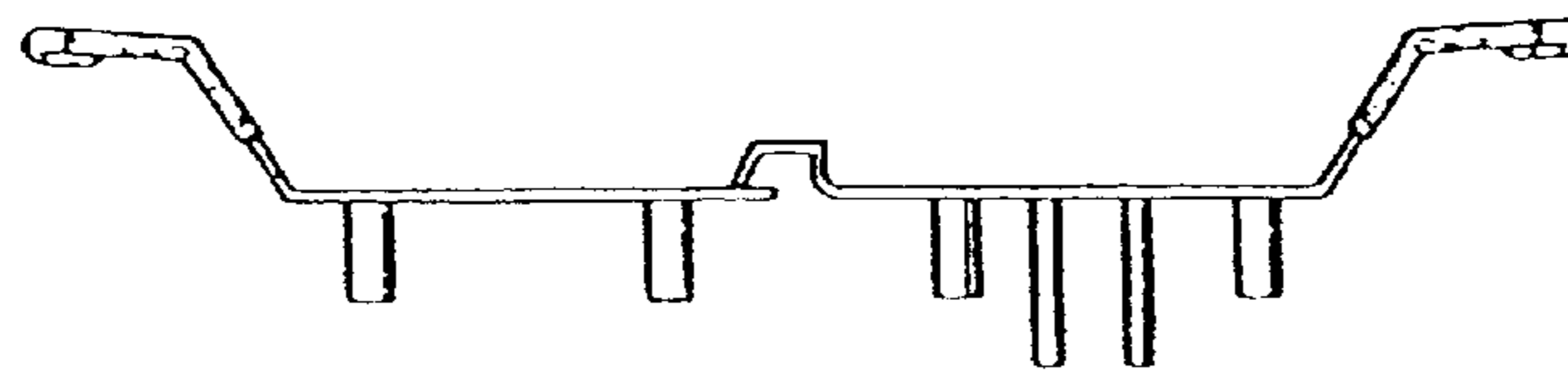

FIG. 8

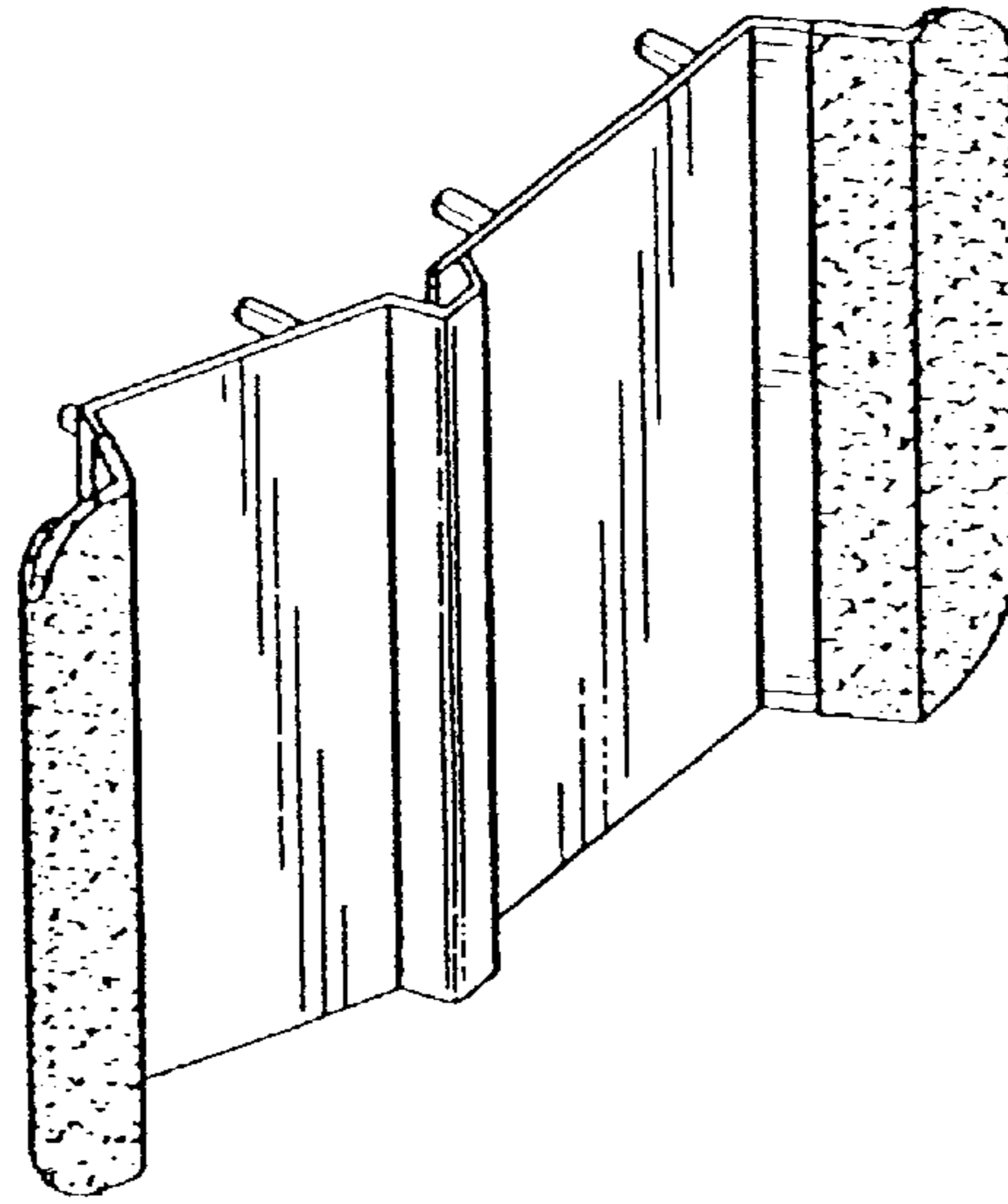

FIG. 9

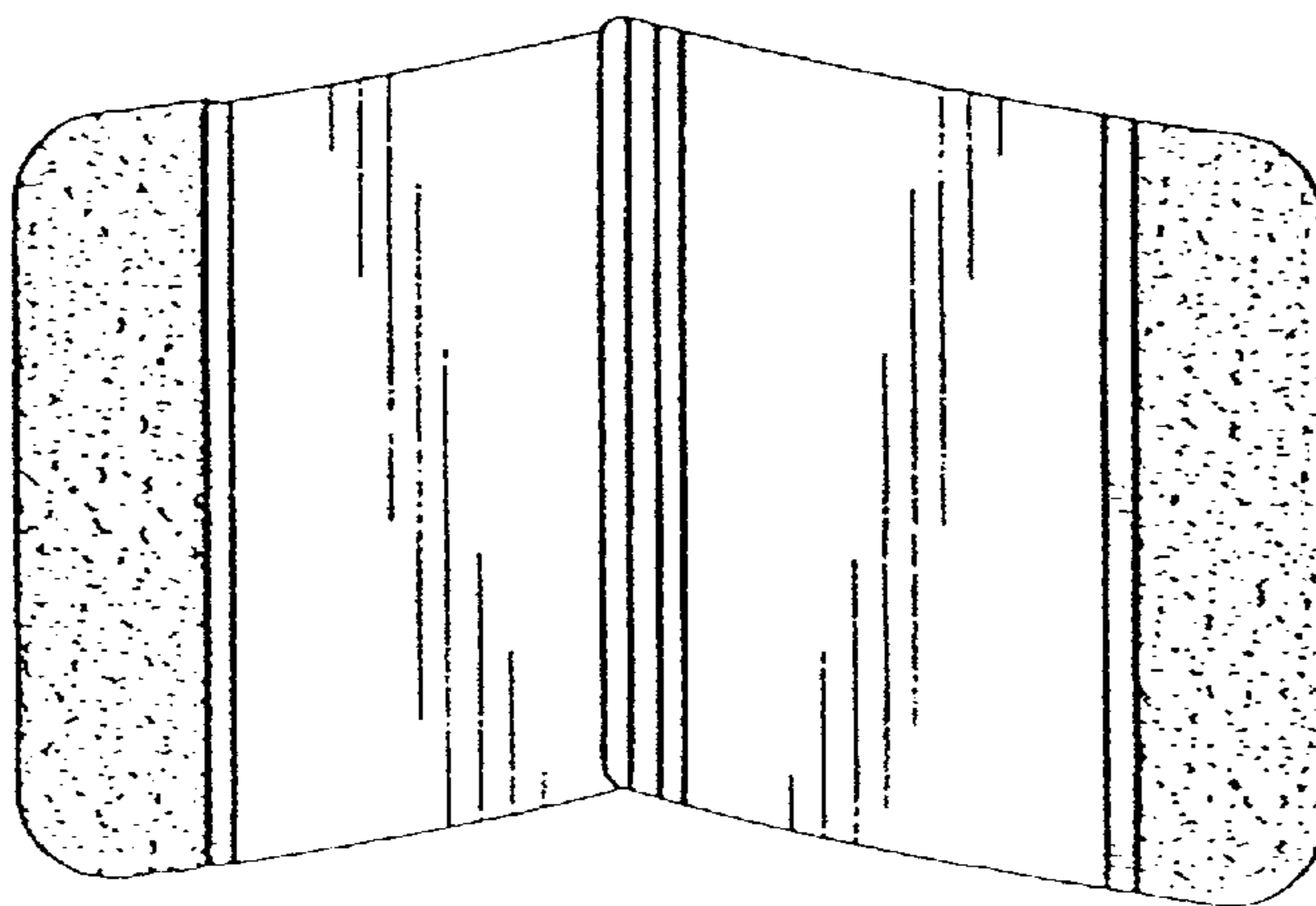

FIG. 10

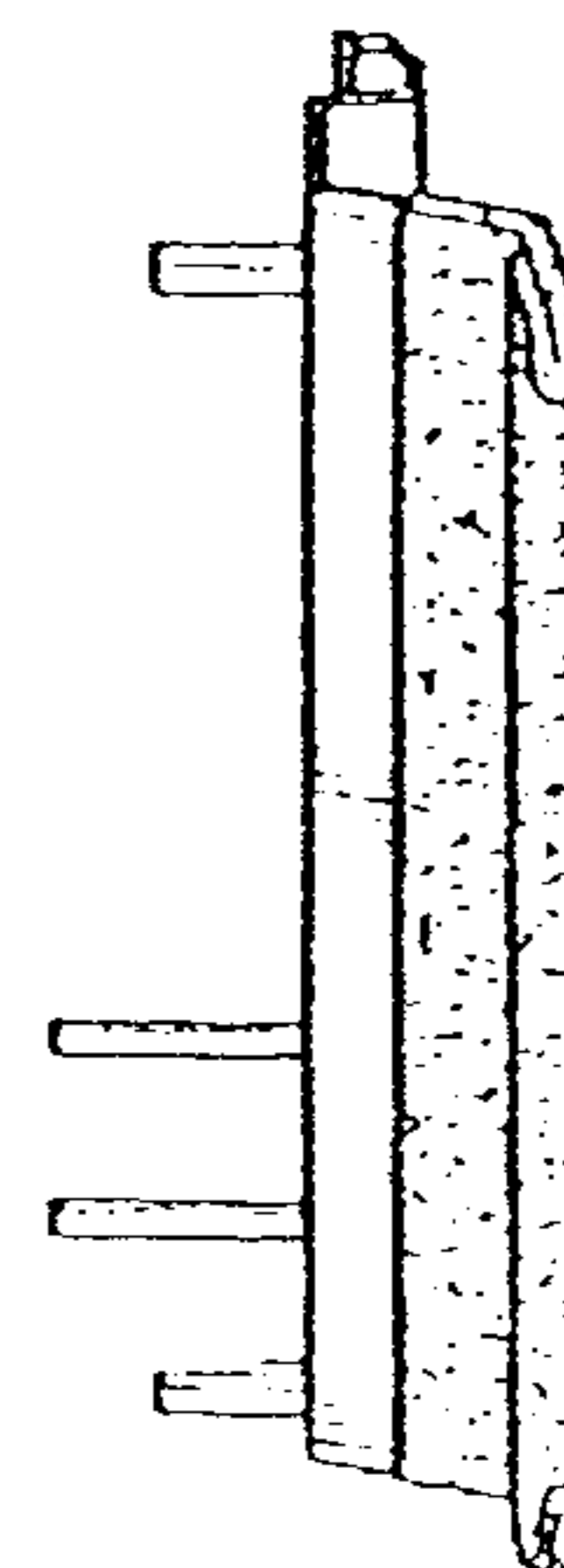

FIG. 11

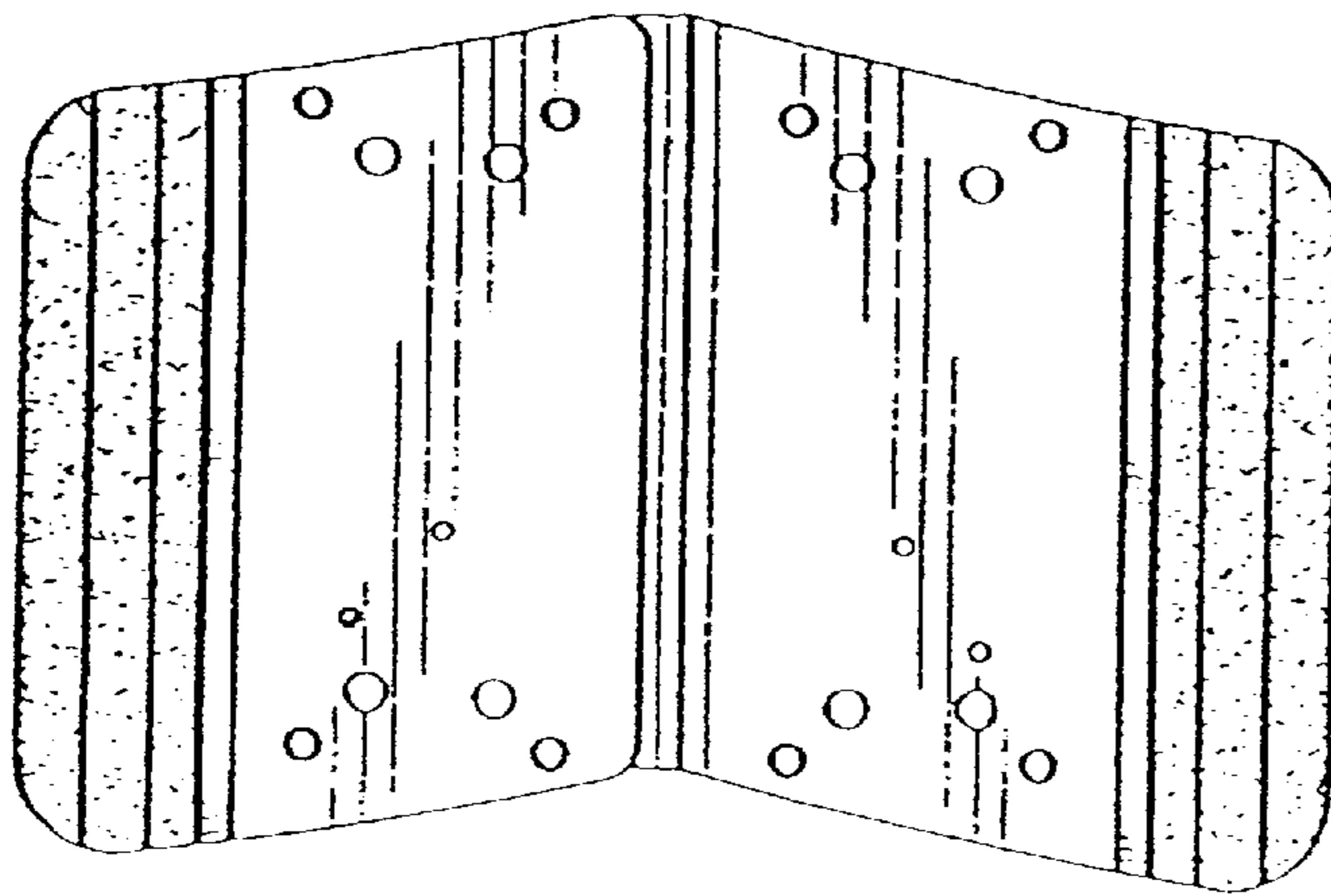

FIG. 12

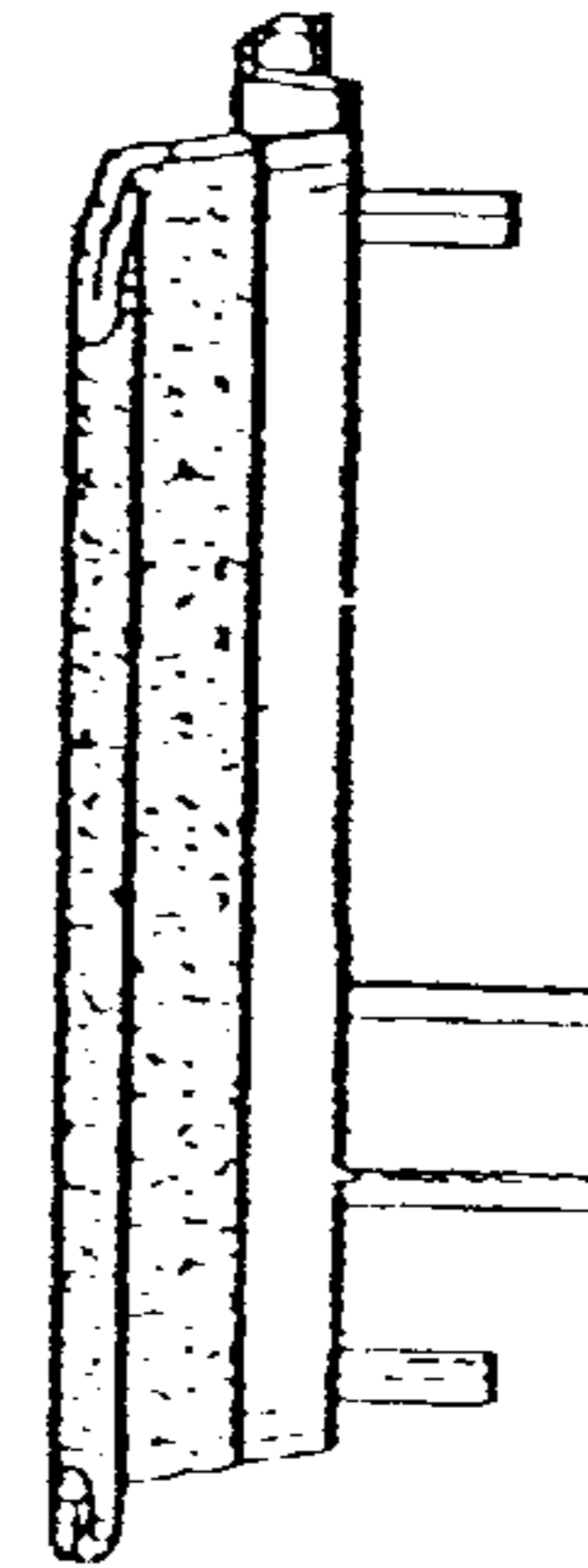

FIG. 13

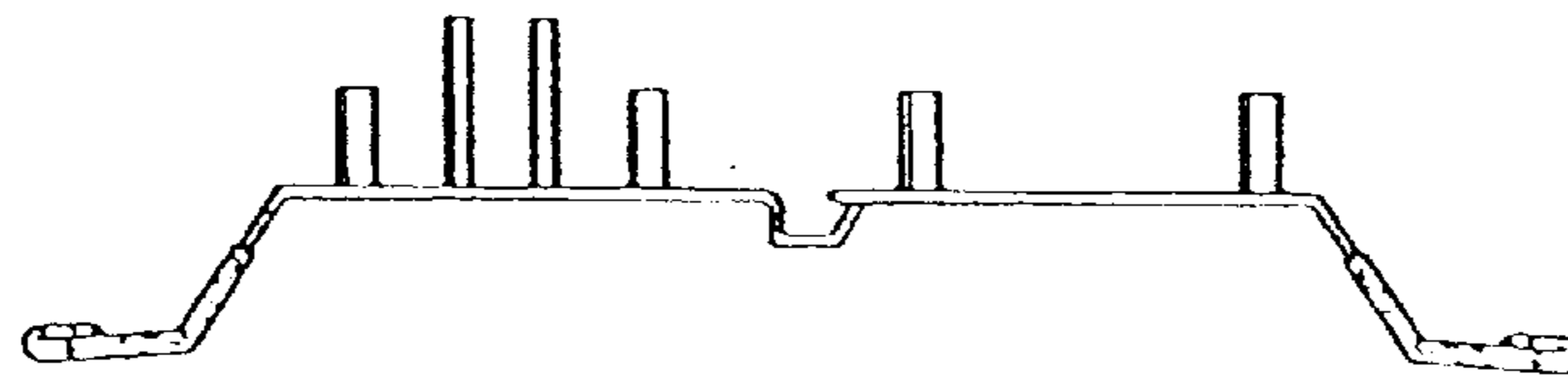

FIG. 14

