



US00D514879S

(12) **United States Design Patent**  
Norris et al.

(10) **Patent No.:** US D514,879 S  
(45) **Date of Patent:** \*\* Feb. 14, 2006

- (54) **BEVERAGEWARE HANDLE**
- (75) Inventors: **Daniel A. Norris**, Williamsville, NY  
(US); **Ron Lapsker**, Maple (CA)
- (73) Assignee: **Prosoft International, Inc.**, St. Michael  
(BB)
- (\*\*) Term: **14 Years**
- (21) Appl. No.: **29/222,290**
- (22) Filed: **Jan. 27, 2005**
- (51) **LOC (8) Cl.** ..... **07-01**
- (52) **U.S. Cl.** ..... **D7/394**
- (58) **Field of Classification Search** ..... D7/394,  
D7/510, 511, 536, 396.2, 509, 533, 523, 393,  
D7/396.6; 220/573.1, 703, 23.83, 769, 729,  
220/713; 215/396, 398; 206/217, 527; 229/400;  
294/31.2, 33; 248/346.1, 205; D23/332  
See application file for complete search history.

- D432,359 S \* 10/2000 Madden-Askew ..... D7/536
- D435,195 S \* 12/2000 Joergensen ..... D7/536
- D436,294 S \* 1/2001 Marck ..... D7/511
- D476,528 S \* 7/2003 Janky et al. .... D7/536
- D481,590 S \* 11/2003 Lin ..... D7/510
- D505,295 S \* 5/2005 Norris et al. .... D7/394

\* cited by examiner

*Primary Examiner*—Ruth McInroy  
*Assistant Examiner*—Terrence Huang  
(74) *Attorney, Agent, or Firm*—Hodgson Russ LLP

(57) **CLAIM**

The ornamental design for beverageware handle, as shown and described.

**DESCRIPTION**

FIG. 1 is a perspective view of a beverageware handle showing our new design; FIG. 2 is a right-hand side elevational view thereof, the left-hand side elevational view being a mirror image; FIG. 3 is a front elevational view thereof; FIG. 4 is a rear elevational view thereof; FIG. 5 is a top plan view thereof; and, FIG. 6 is a bottom plan view thereof. The broken lines in FIG. 1 are for illustrative purposes only and form no part of the claimed design.

**1 Claim, 1 Drawing Sheet**

- (56) **References Cited**  
U.S. PATENT DOCUMENTS  
D356,234 S \* 3/1995 Wolfenden ..... D7/536  
D363,415 S \* 10/1995 Carlson ..... D7/536  
D409,441 S \* 5/1999 Stephenson ..... D7/510  
D427,853 S \* 7/2000 Kohlhase ..... D7/510

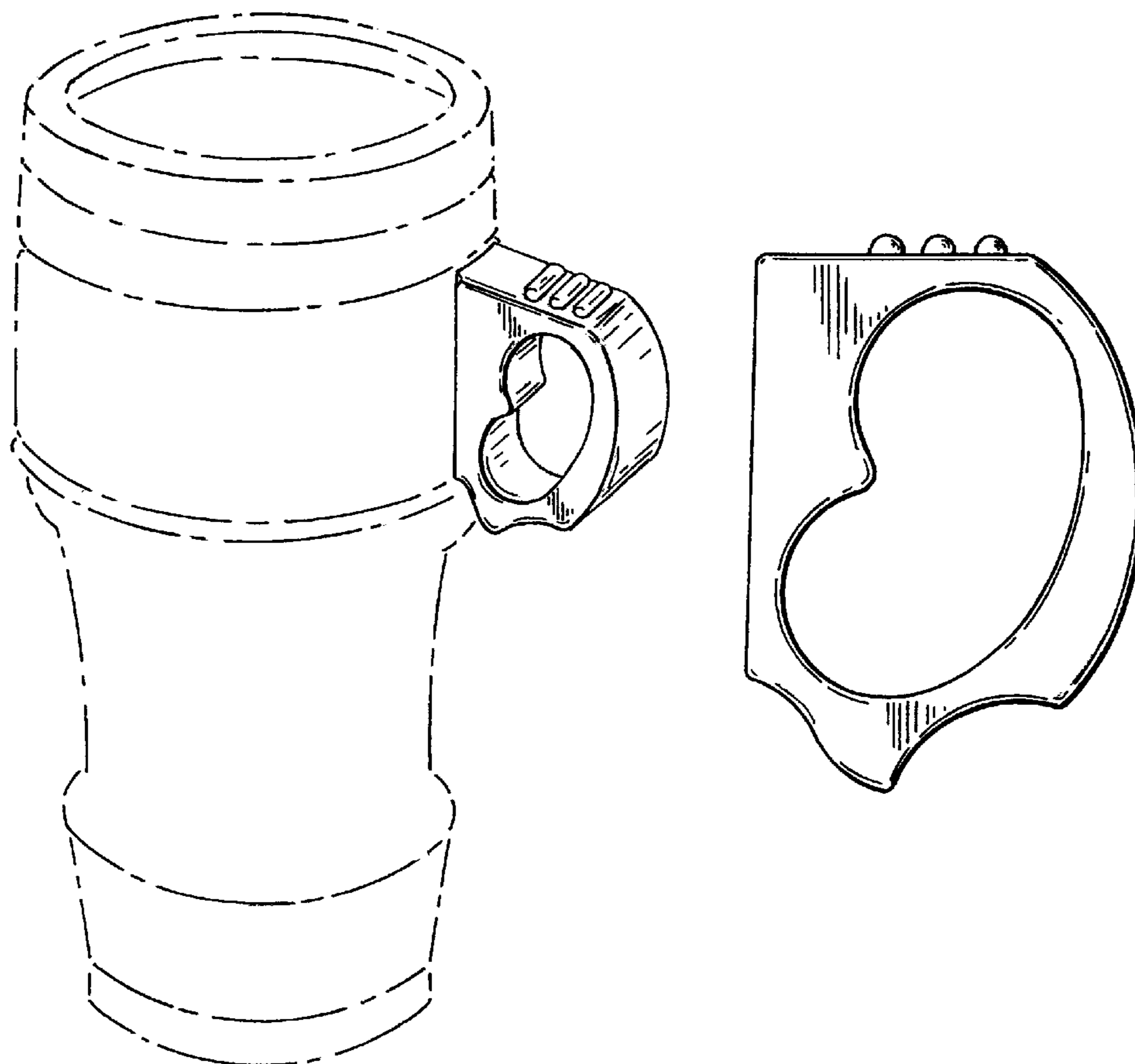

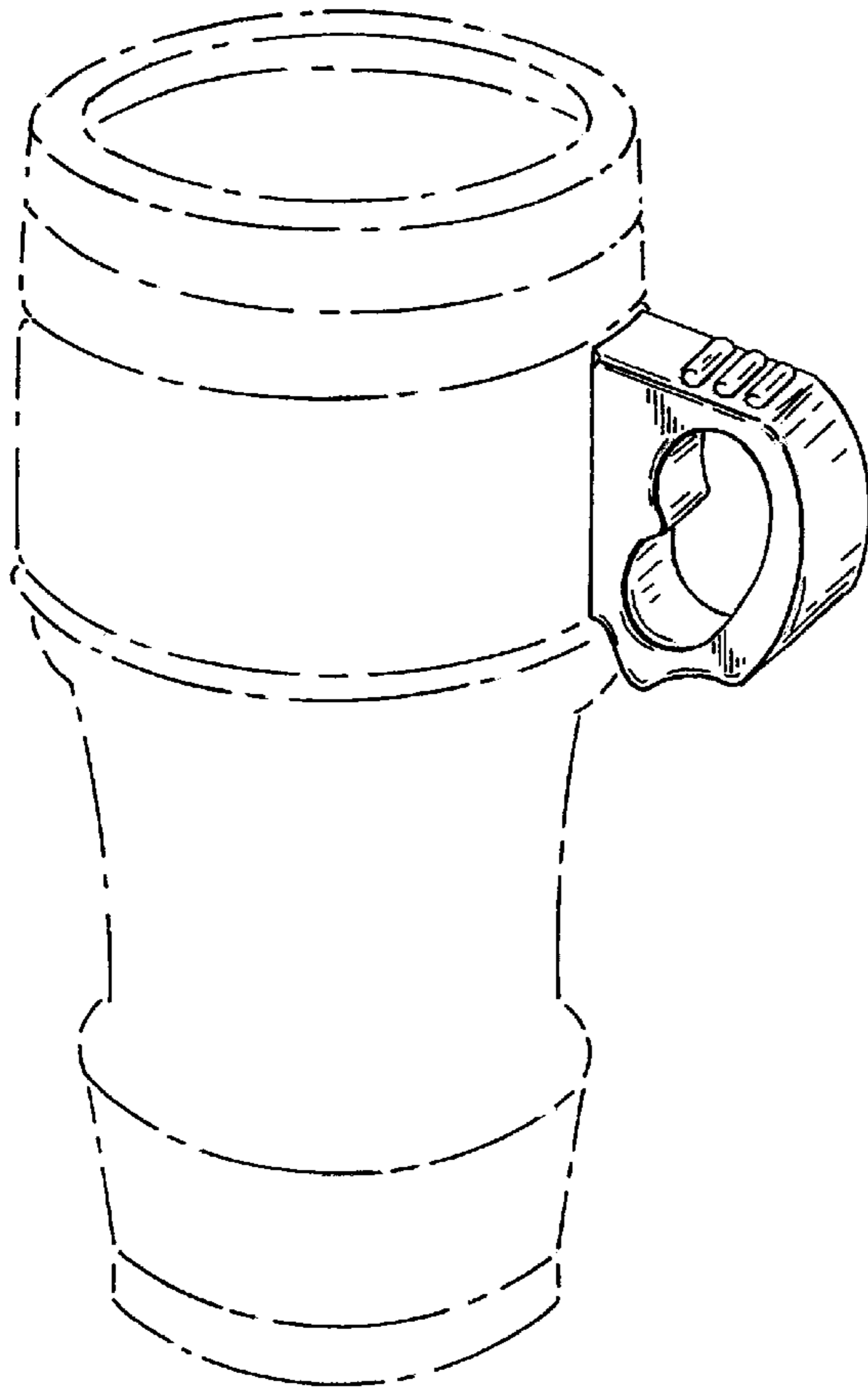

FIG. 1

FIG. 2

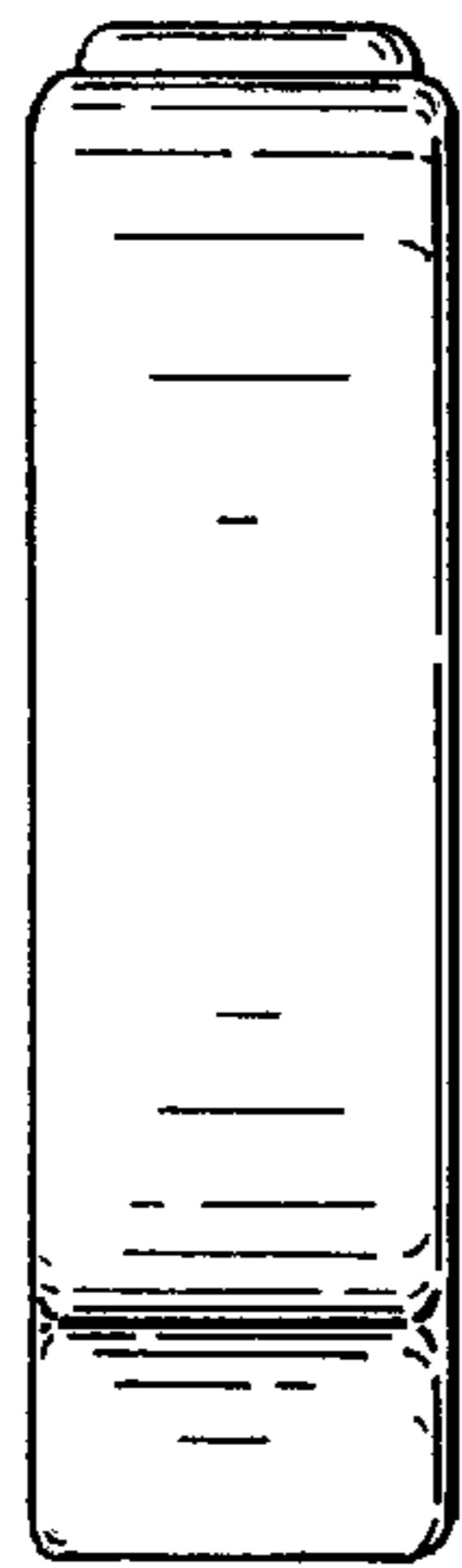
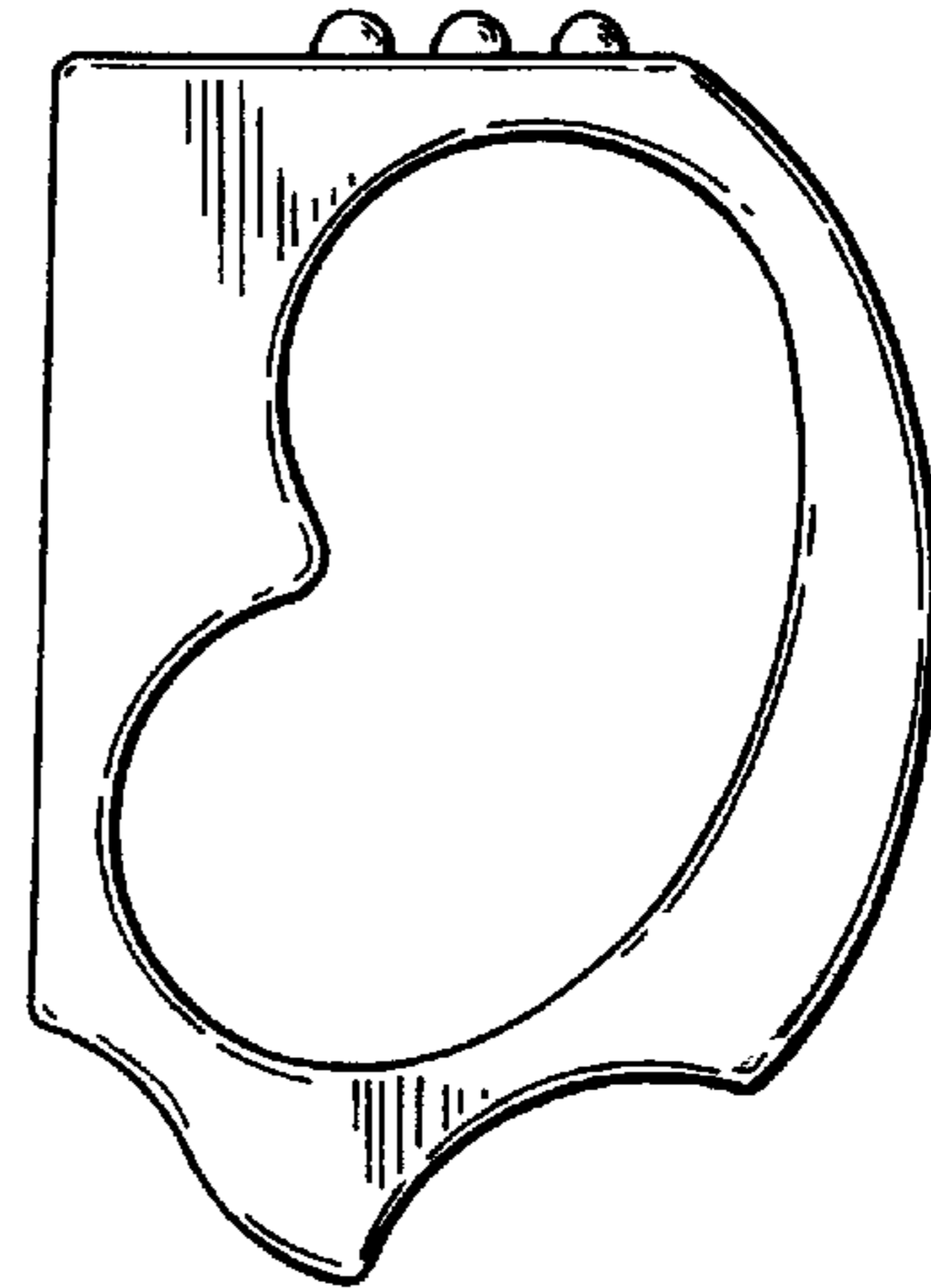

FIG. 3

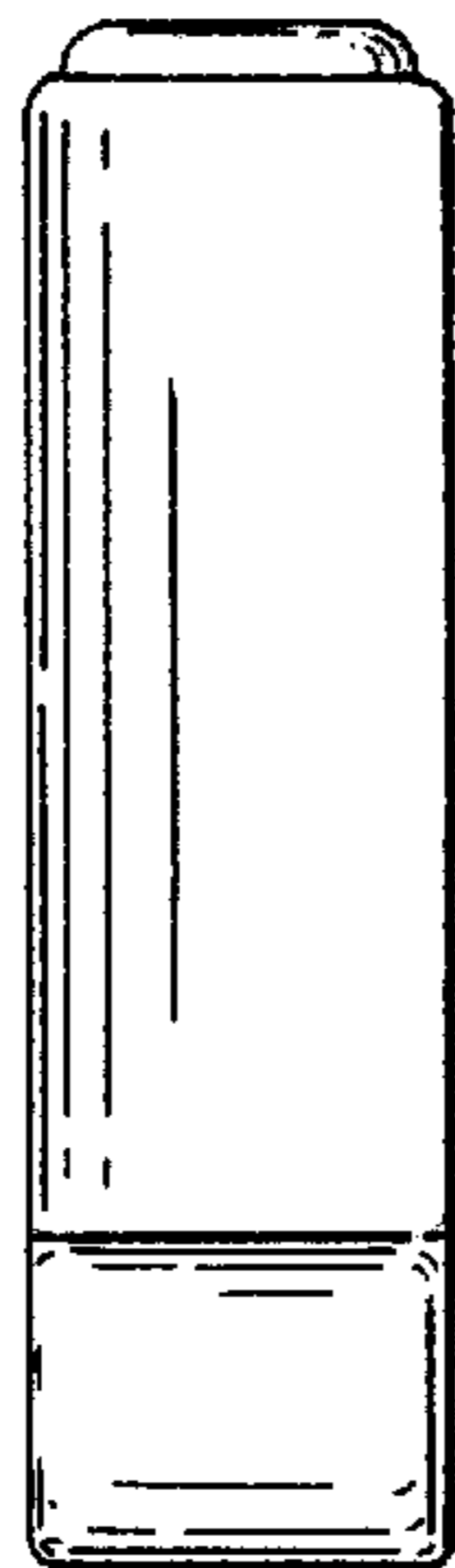

FIG. 4

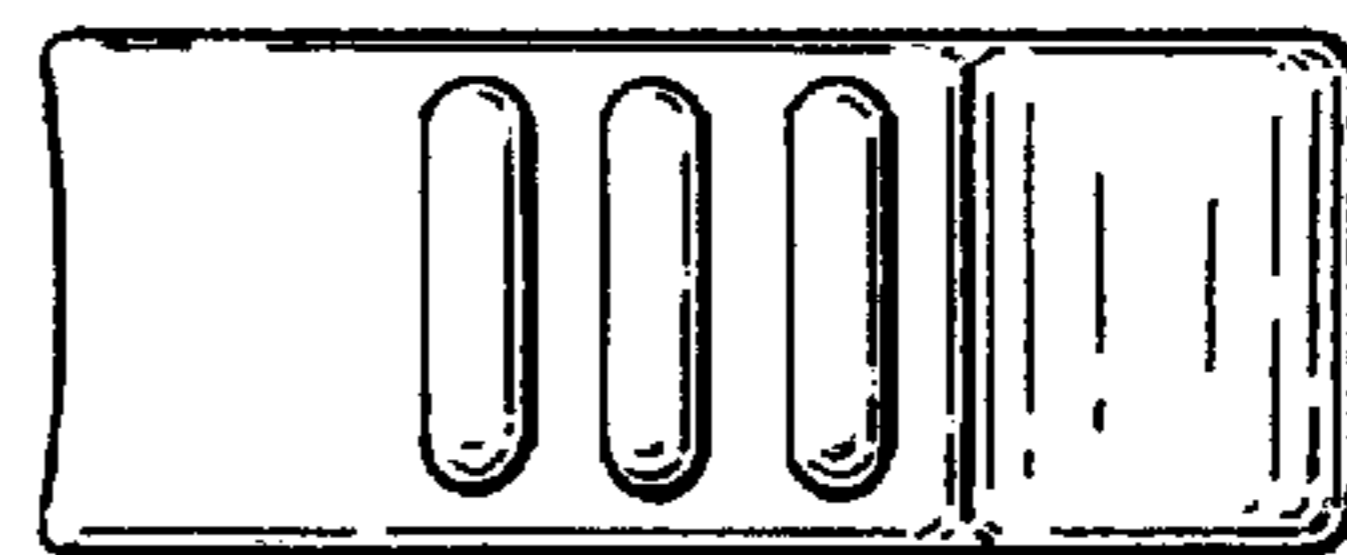

FIG. 5

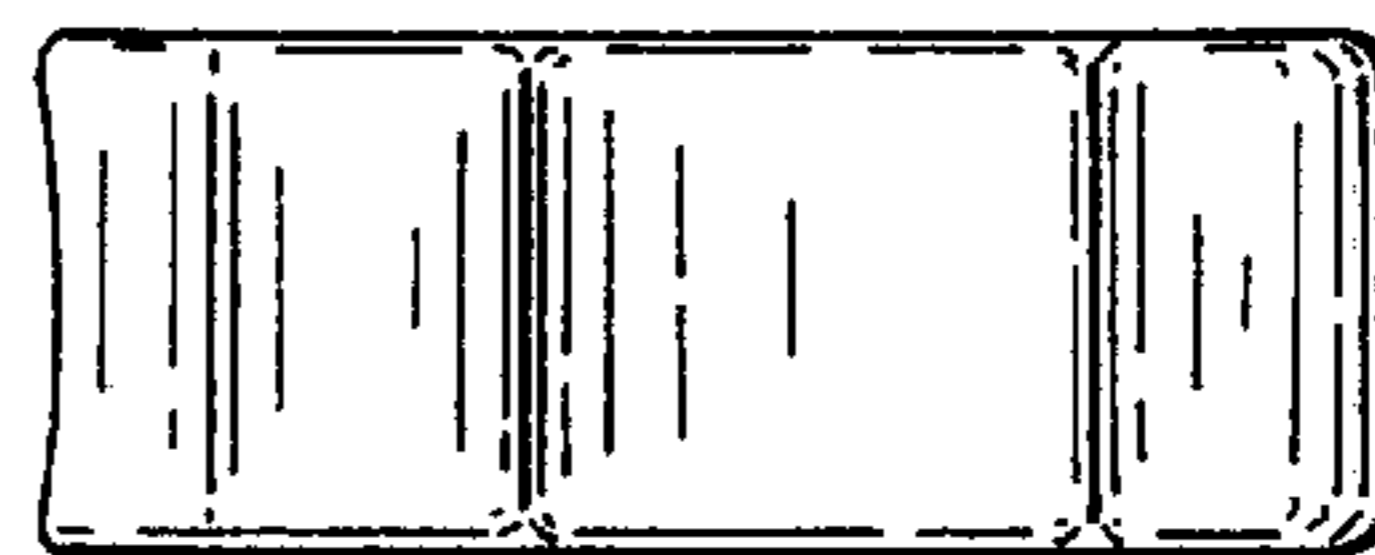

FIG. 6