



US00D514876S

(12) **United States Design Patent**
Simond

(10) **Patent No.:** **US D514,876 S**

(45) **Date of Patent:** **** Feb. 14, 2006**

(54) **BARBEQUE**

(75) Inventor: **Thierry Simond, Les Echelles (FR)**

(73) Assignee: **Tefal S.A., Rumilly (FR)**

(**) Term: **14 Years**

(21) Appl. No.: **29/200,431**

(22) Filed: **Feb. 27, 2004**

(30) **Foreign Application Priority Data**

Aug. 29, 2003 (FR) 03 4183

(51) **LOC (8) Cl.** **07-02**

(52) **U.S. Cl.** **D7/363**

(58) **Field of Classification Search** D7/332,
D7/334-337, 402-405, 393-395, 355, 359,
D7/362-367; 126/25 R, 25 A, 25 AA, 41 R,
126/9 R, 38, 39 H, 39 BA; 99/401, 425,
99/446-447, 450, 481, 445, 349, 422; 219/450.1,
219/452.12, 533; D8/315-320; D9/506, 518,
D9/428

See application file for complete search history.

(56) **References Cited**

U.S. PATENT DOCUMENTS

D190,212 S * 4/1961 Ernest D7/363
D276,303 S * 11/1984 Chan D7/337
D278,505 S * 4/1985 Mackin D7/337
D291,399 S * 8/1987 Chan D7/337
D375,868 S * 11/1996 Larson D7/361

D406,722 S * 3/1999 Benton et al. D7/362
D412,808 S * 8/1999 Hinton et al. D7/362
D431,152 S * 9/2000 Lee D7/362
D450,976 S * 11/2001 Mosher D7/337
6,363,835 B1 * 4/2002 Wu 99/331
6,484,624 B1 * 11/2002 Wu 99/339
D469,298 S * 1/2003 Hinton et al. D7/332
D505,044 S * 5/2005 Hei D7/363

* cited by examiner

Primary Examiner—Ruth McInroy

(74) *Attorney, Agent, or Firm*—Fross, Zelnick Lehrman & Zissu, P.C.; David I. Greenbaum, Esq.

(57) **CLAIM**

The ornamental design for a barbeque, as shown and described.

DESCRIPTION

FIG. 1 is a perspective view of a barbeque showing my new design;
FIG. 2 is a perspective view thereof, in an opened position;
FIG. 3 is a top view thereof;
FIG. 4 is a bottom view thereof;
FIG. 5 is a front view thereof;
FIG. 6 is a front view thereof, in an opened position;
FIG. 7 is a rear view thereof;
FIG. 8 is a rear view thereof, in an opened position;
FIG. 9 is a left side view thereof in an opened position, the right side being a mirror image; and,
FIG. 10 is a left side view thereof.

1 Claim, 10 Drawing Sheets

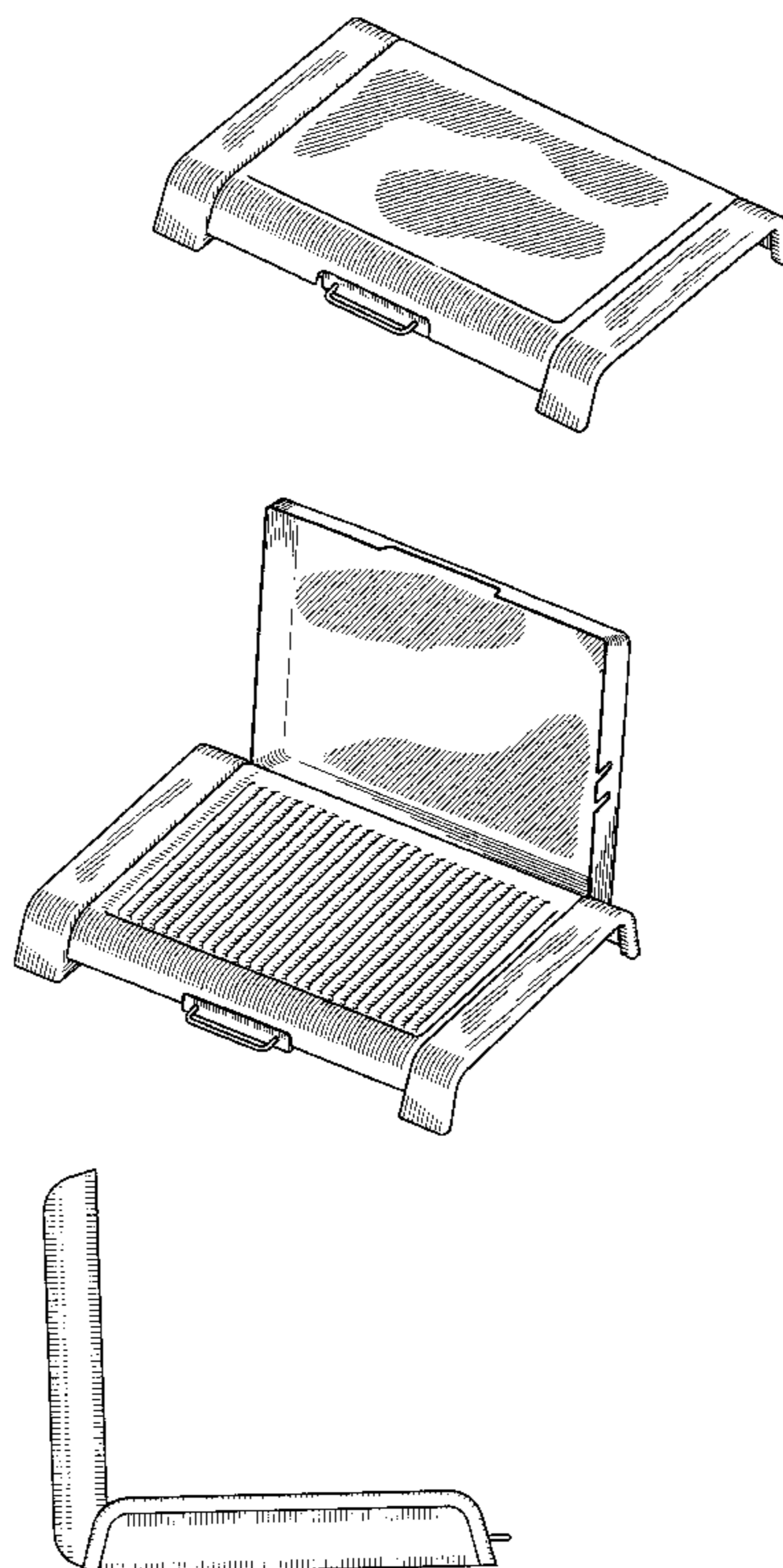

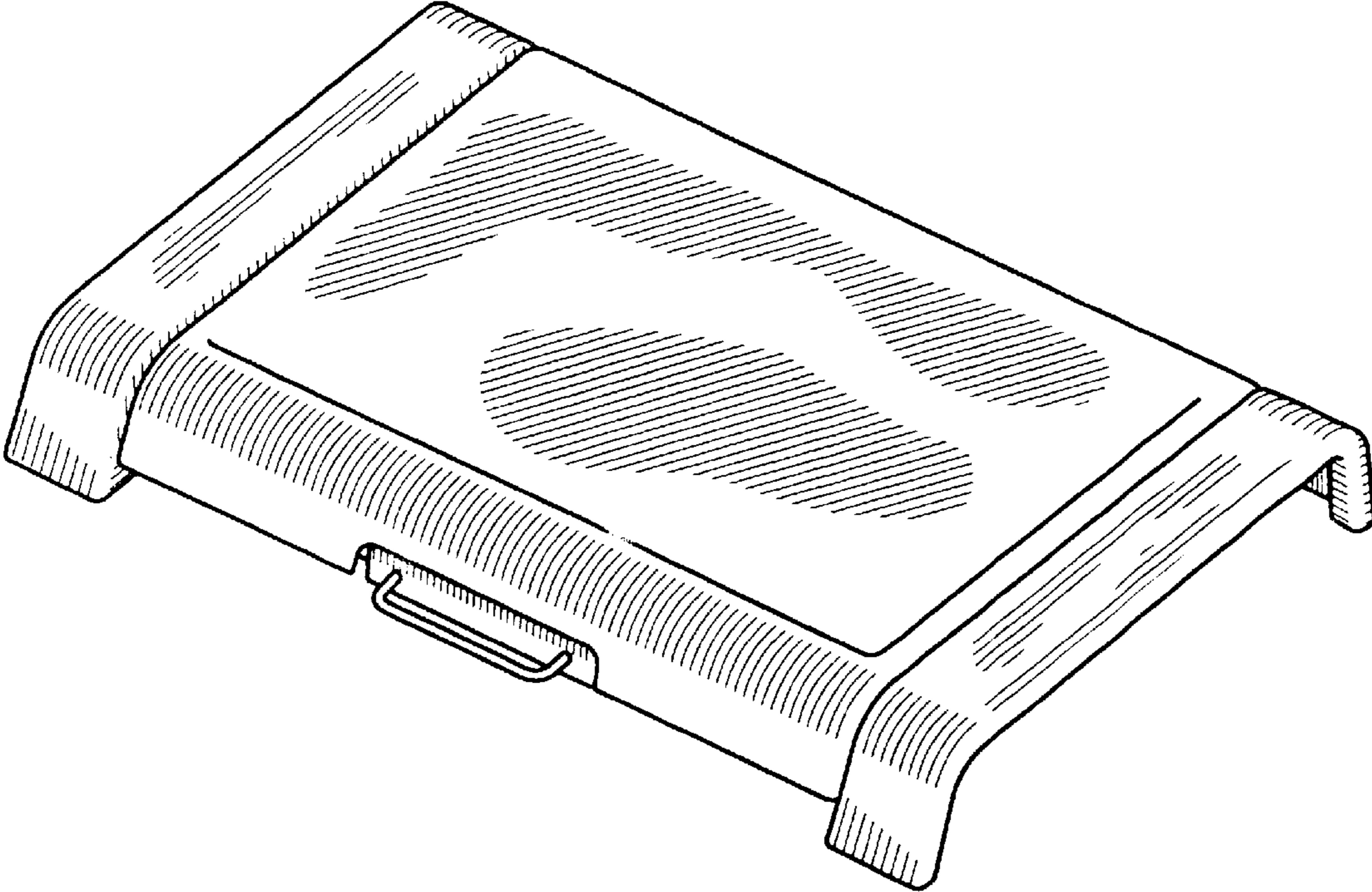

Fig. 1

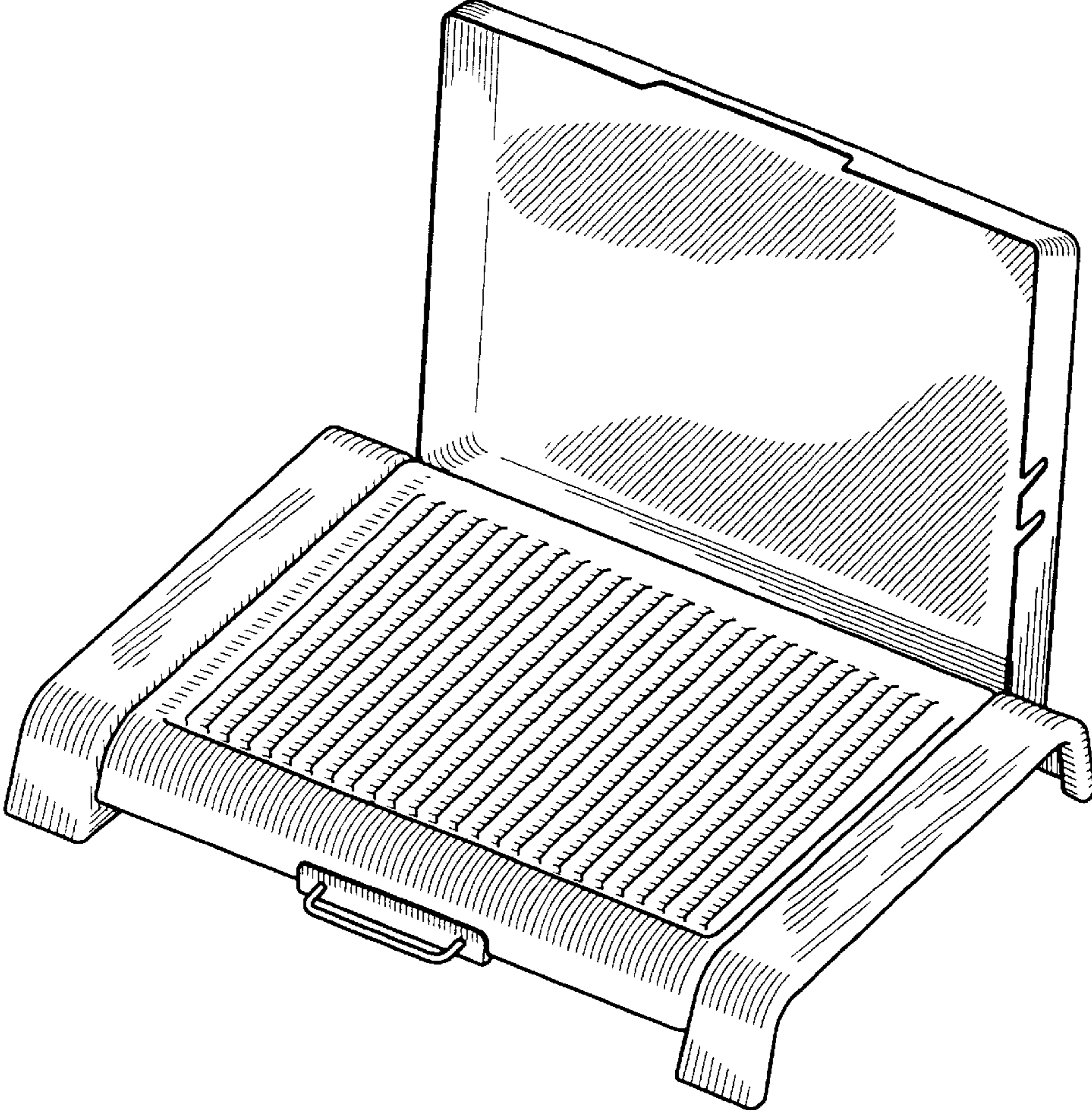

Fig. 2

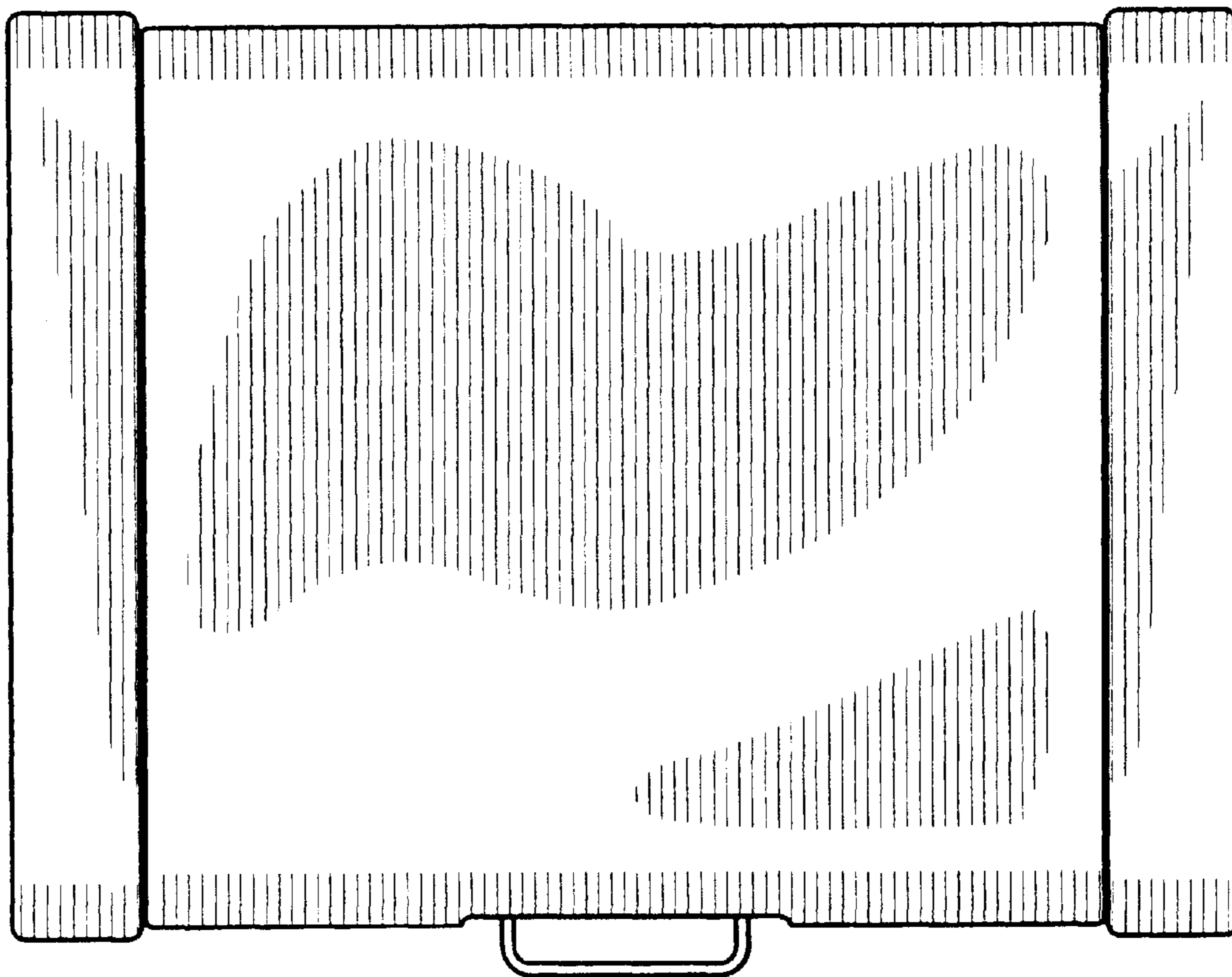

Fig. 3

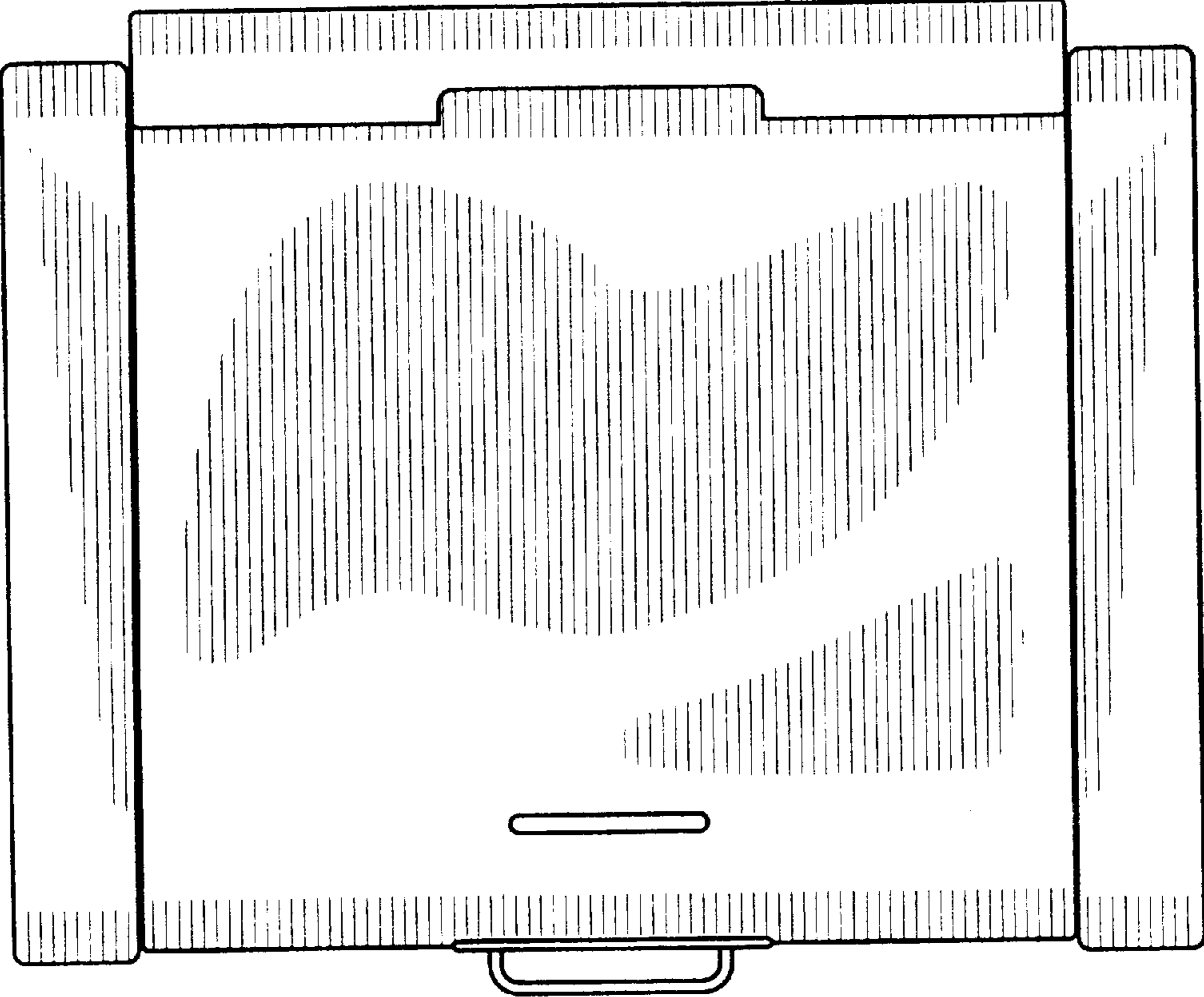

Fig. 4

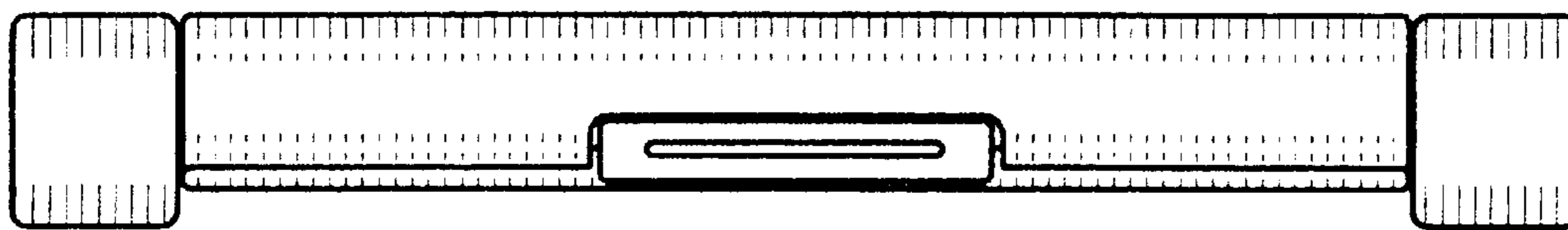

Fig. 5

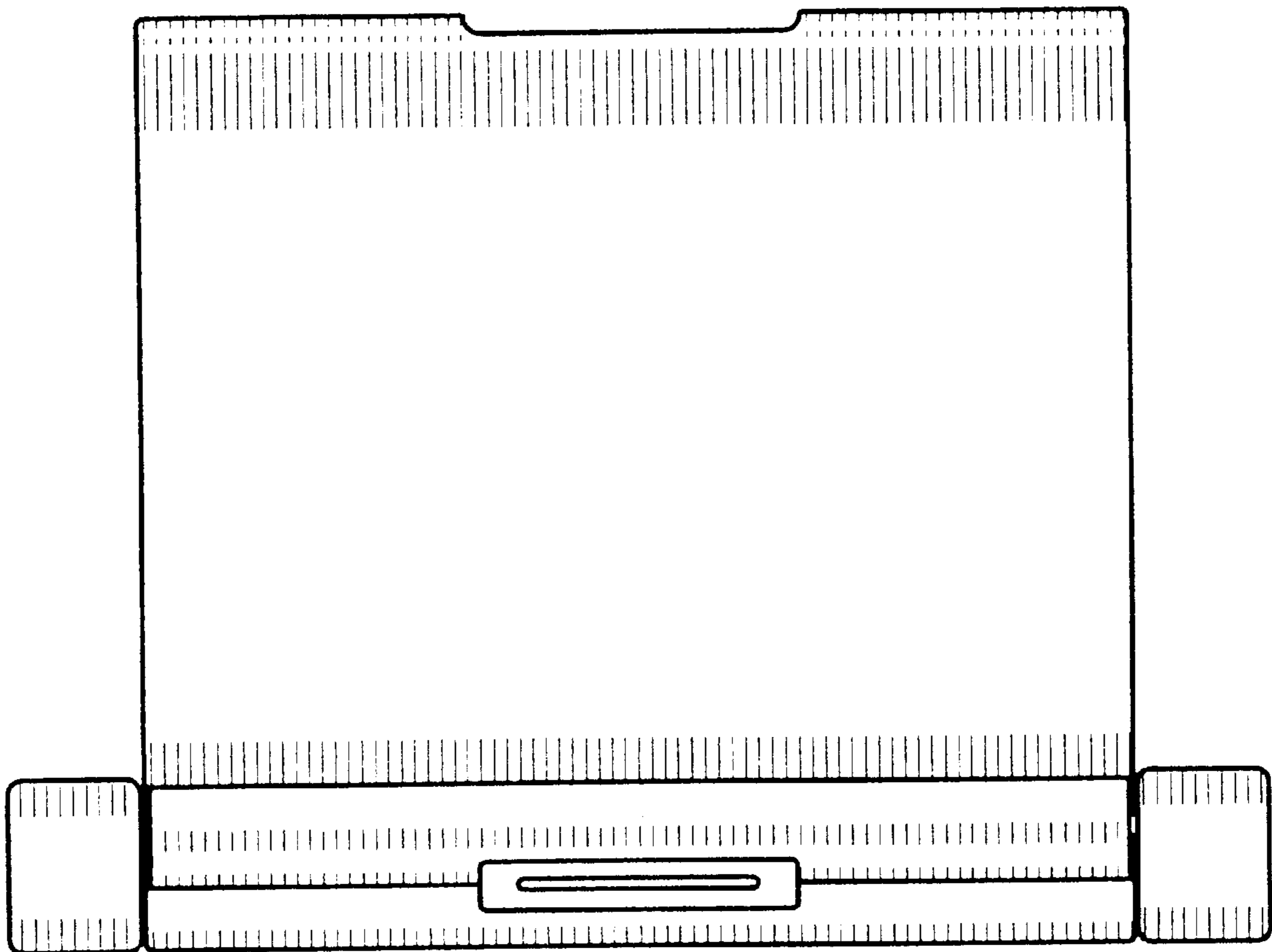

Fig. 6

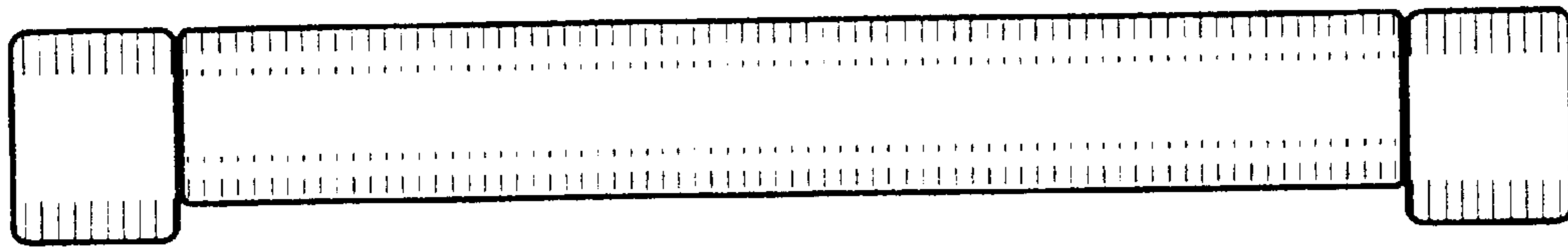

Fig. 7

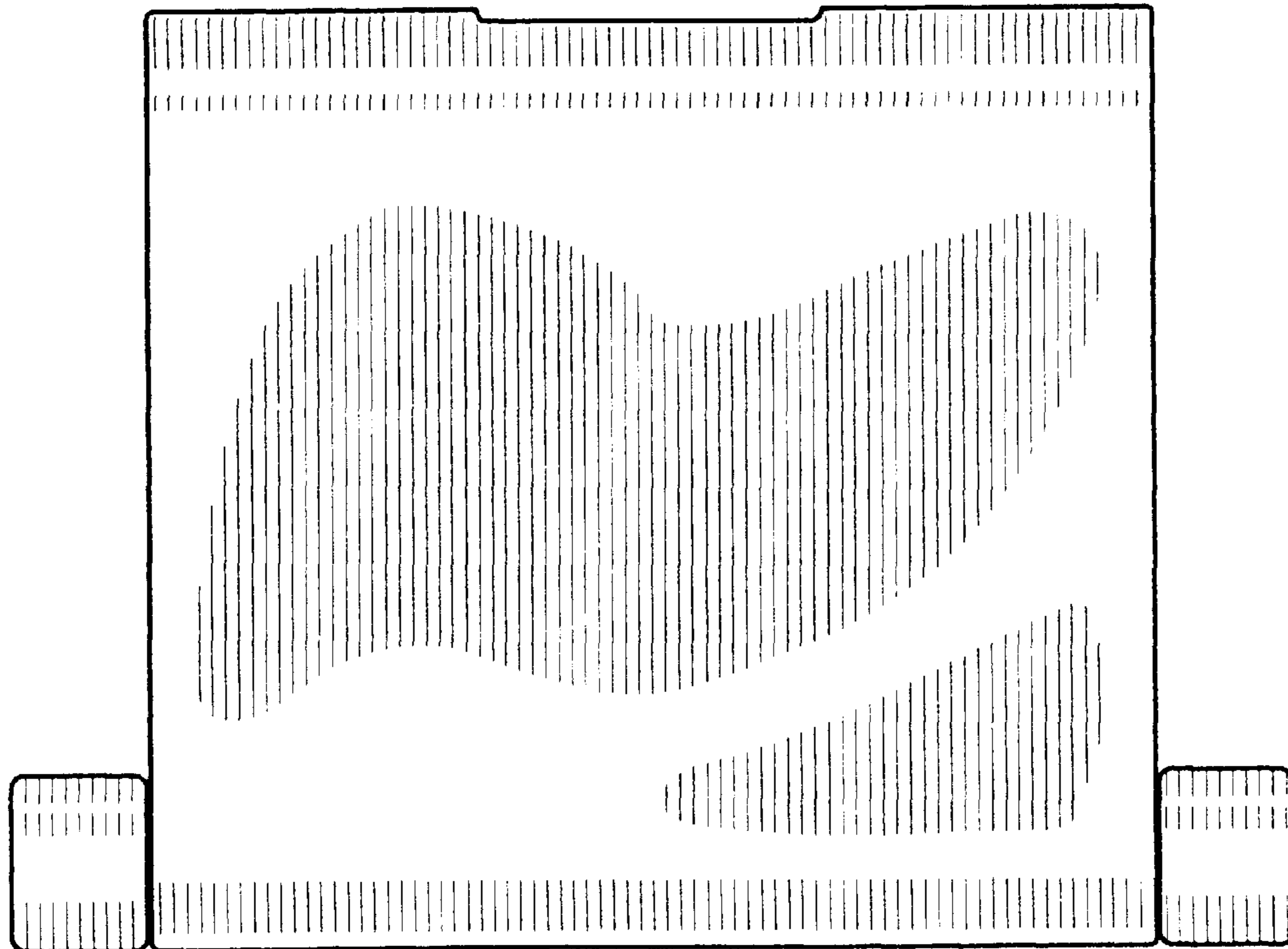

Fig. 8

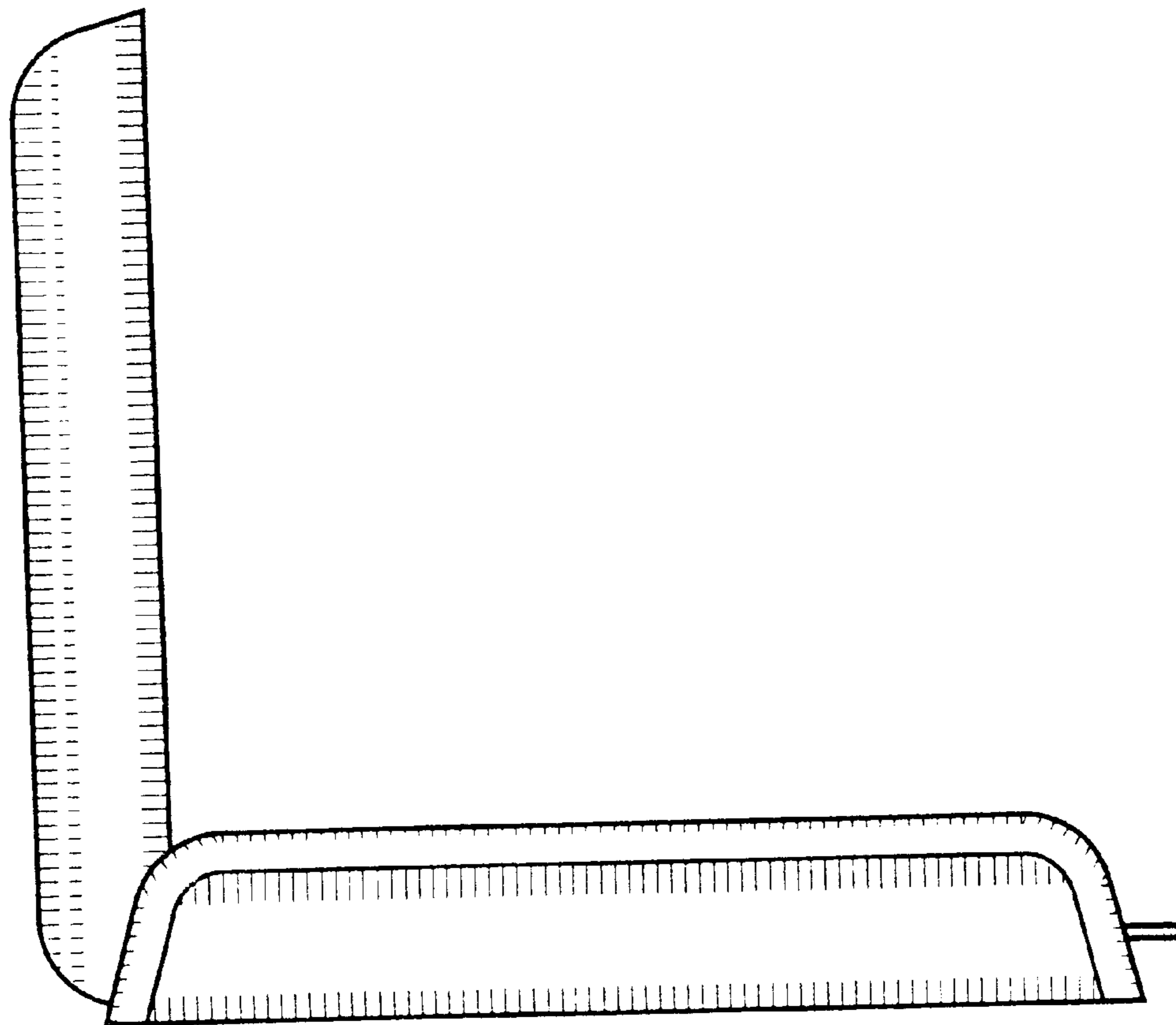

Fig. 9

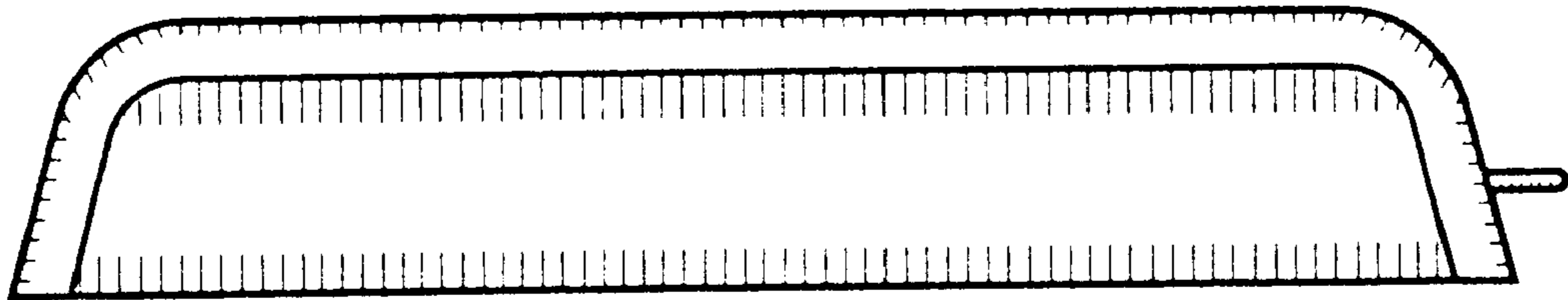

Fig. 10