



US00D514806S

(12) **United States Design Patent**
McCambridge et al.

(10) **Patent No.:** **US D514,806 S**
(45) **Date of Patent:** **** Feb. 14, 2006**

(54) **COMBINED CLIPPER HOLSTER AND BATTERY PACK**

Primary Examiner—Catherine R. Oliver

(75) Inventors: **James E. McCambridge**, Polo, IL (US); **Luther D. Langley**, Sterling, IL (US); **Charles Choi**, Chicago, IL (US)

(74) *Attorney, Agent, or Firm*—Greer, Burns & Crain, Ltd.

(73) Assignee: **Wahl Clipper Corporation**, Sterling, IL (US)

(57) **CLAIM**

The ornamental design for a combined clipper holster and battery pack, as shown and described.

(**) Term: **14 Years**

DESCRIPTION

(21) Appl. No.: **29/217,439**

(22) Filed: **Nov. 17, 2004**

(51) **LOC (8) Cl.** **03-01**

(52) **U.S. Cl.** **D3/228**

(58) **Field of Classification Search** D3/228,
D3/215, 219; 224/902, 904, 930, 240, 256,
224/660, 673, 676; 30/537

See application file for complete search history.

FIG. 1 is a top perspective view of the present combination; FIG. 2 is a front view of same; FIG. 3 is a right side view of the combination of FIG. 1; FIG. 4 is a rear view of same; FIG. 5 is a left side view of the combination of FIG. 1; FIG. 6 is a top view of same; and FIG. 7 is a bottom view of same; FIG. 8 is a top perspective view of an alternate embodiment of the combination of FIG. 1; FIG. 9 is a front view of the combination of FIG. 8; FIG. 10 is a right side view of the combination; FIG. 11 is rear view of same; FIG. 12 is a left side view of the combination of FIG. 8; FIG. 13 is a top view of same; and, FIG. 14 is a bottom view of same.

(56) **References Cited**

U.S. PATENT DOCUMENTS

2,625,192 A	*	1/1953	Kinskie	224/902
D279,424 S	*	7/1985	Leiserson et al.	D3/226
D445,248 S	*	7/2001	Snider	D3/228

* cited by examiner

1 Claim, 6 Drawing Sheets

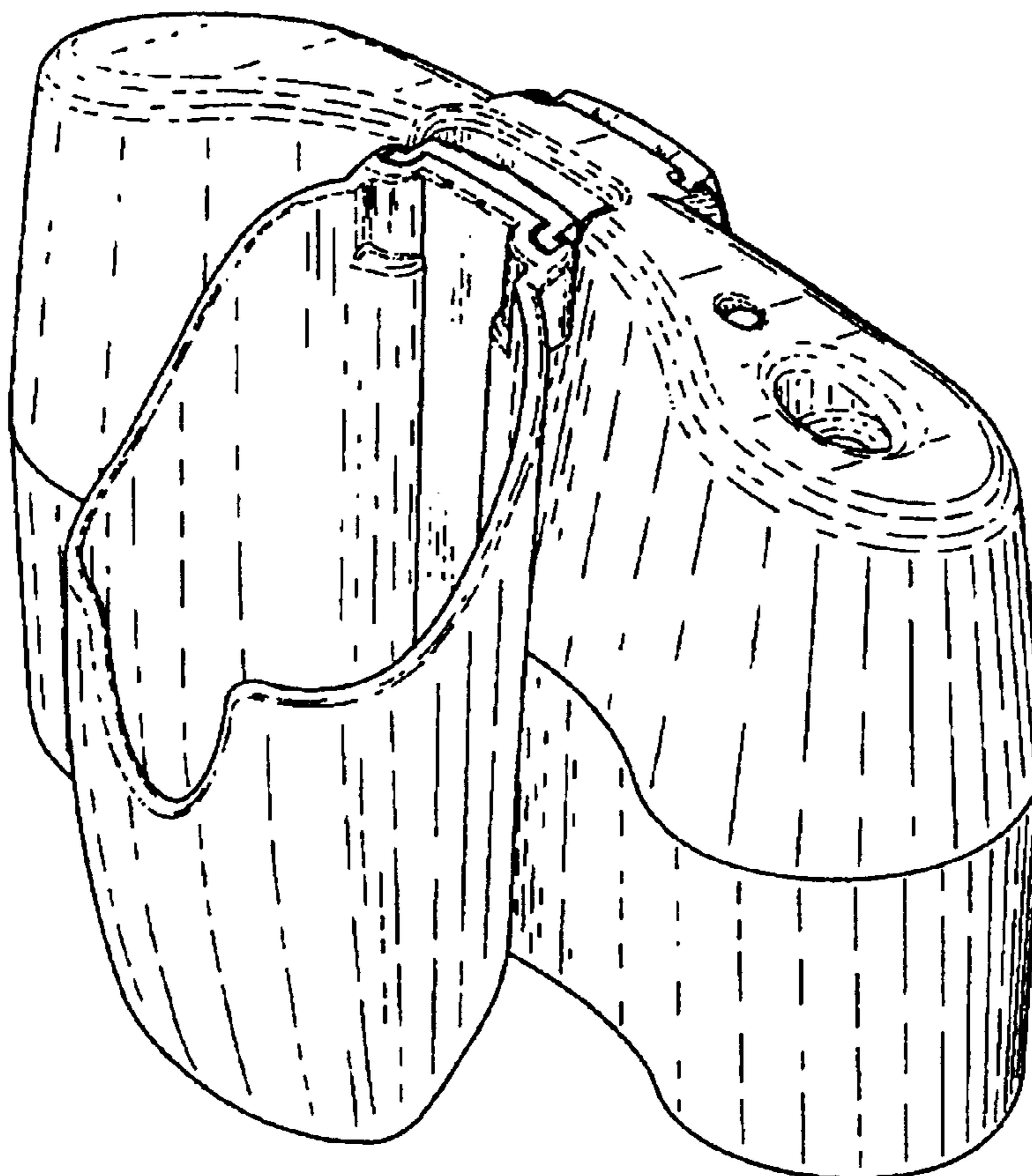

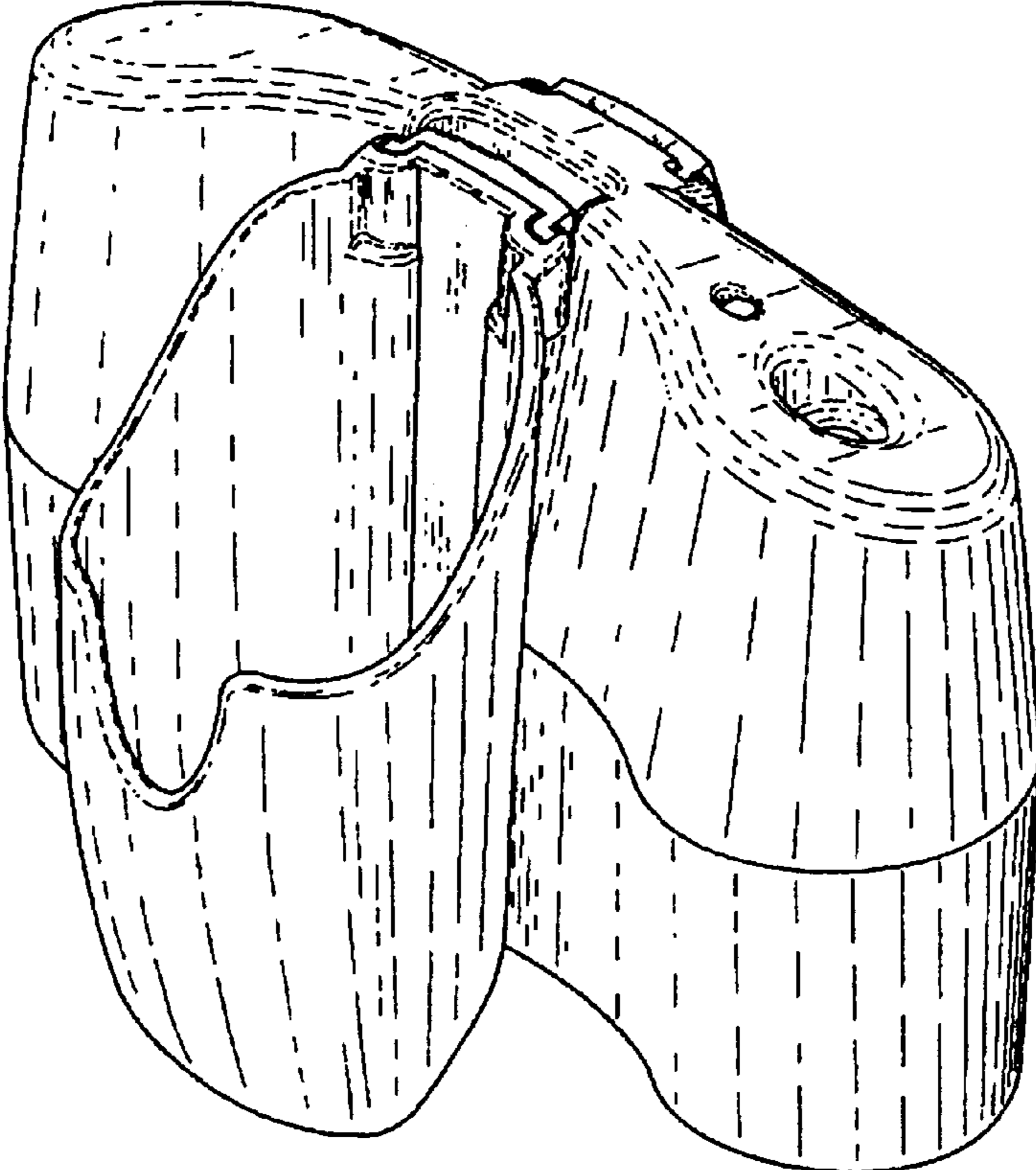

Fig.1

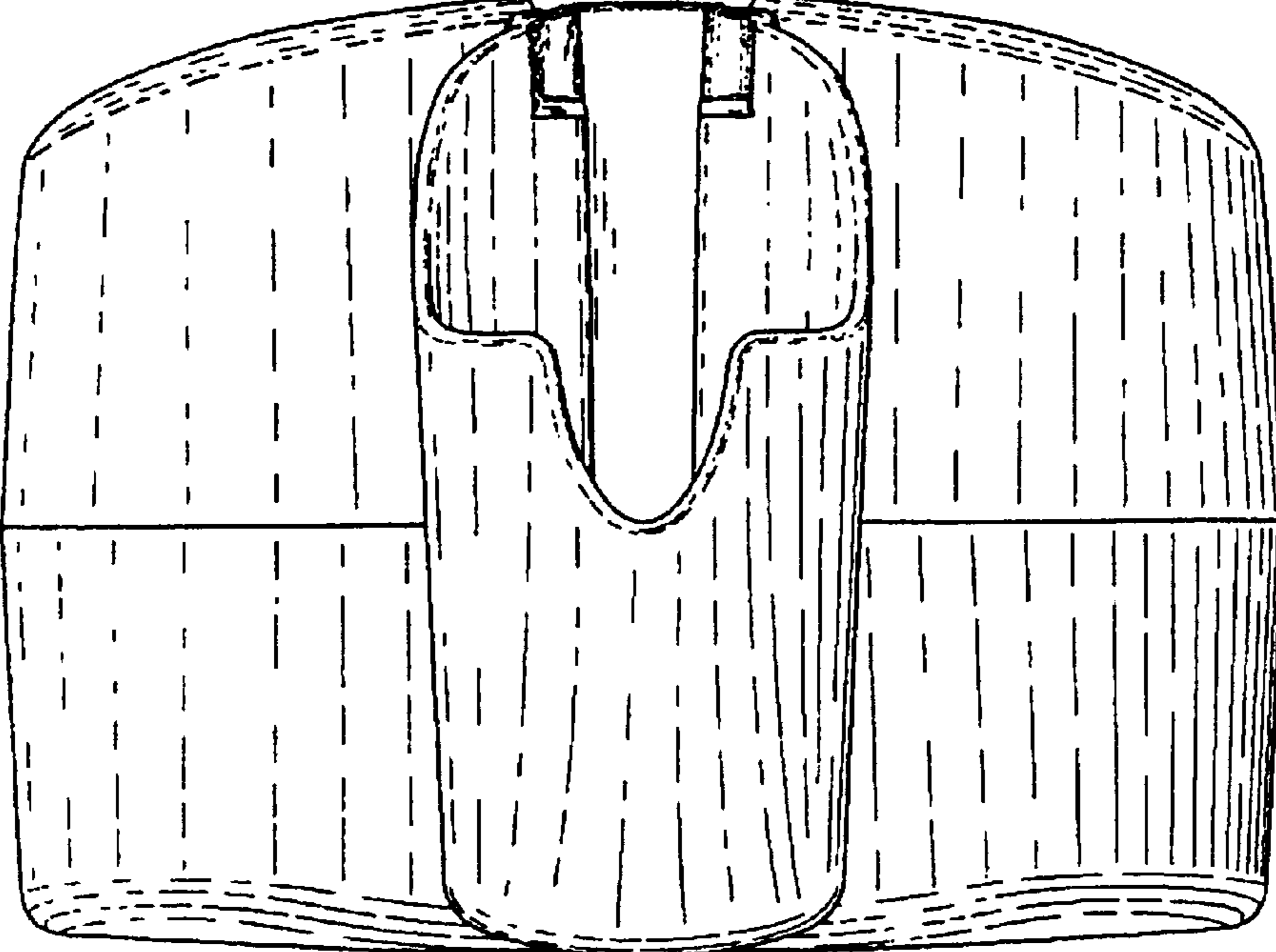

Fig.2

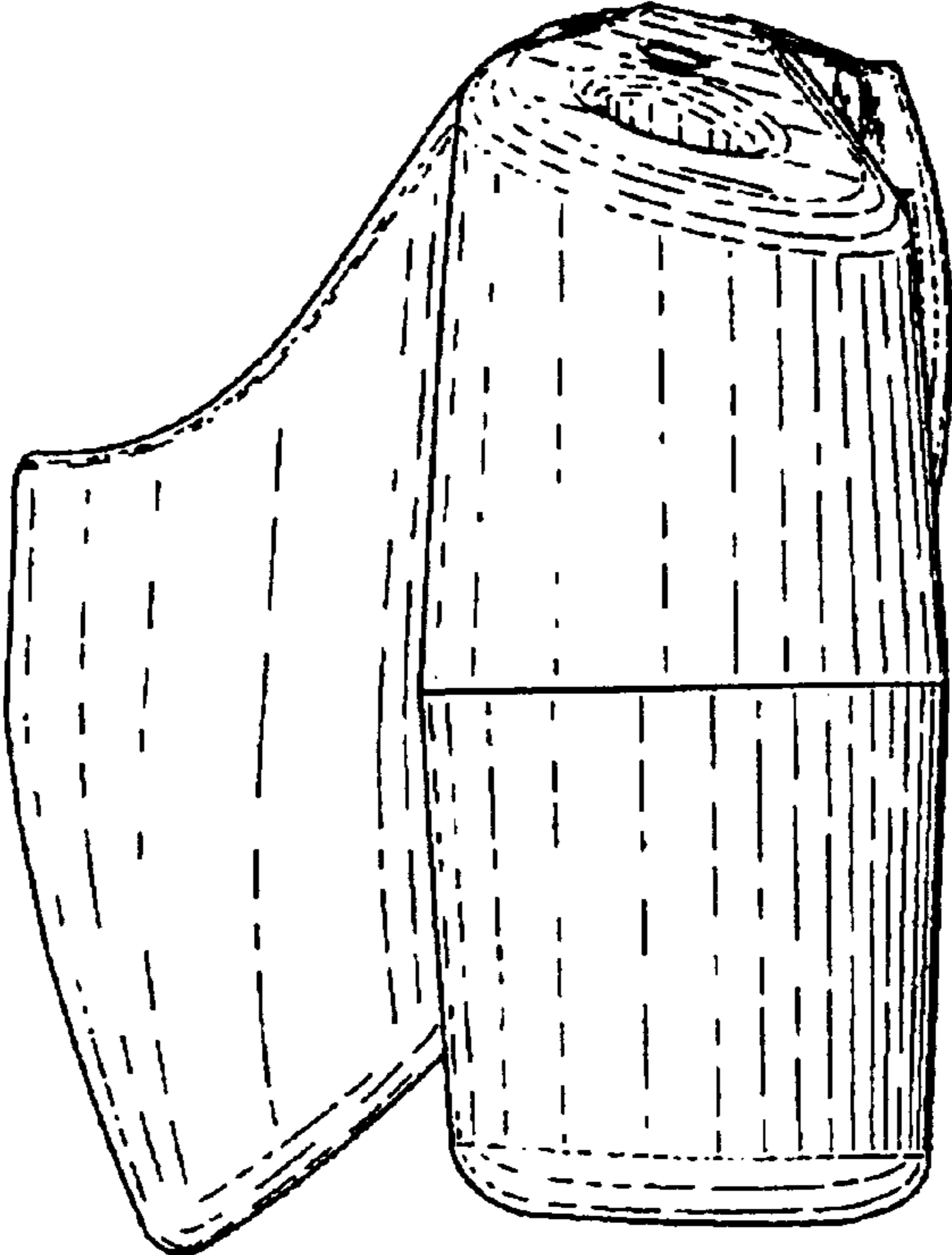

Fig. 3

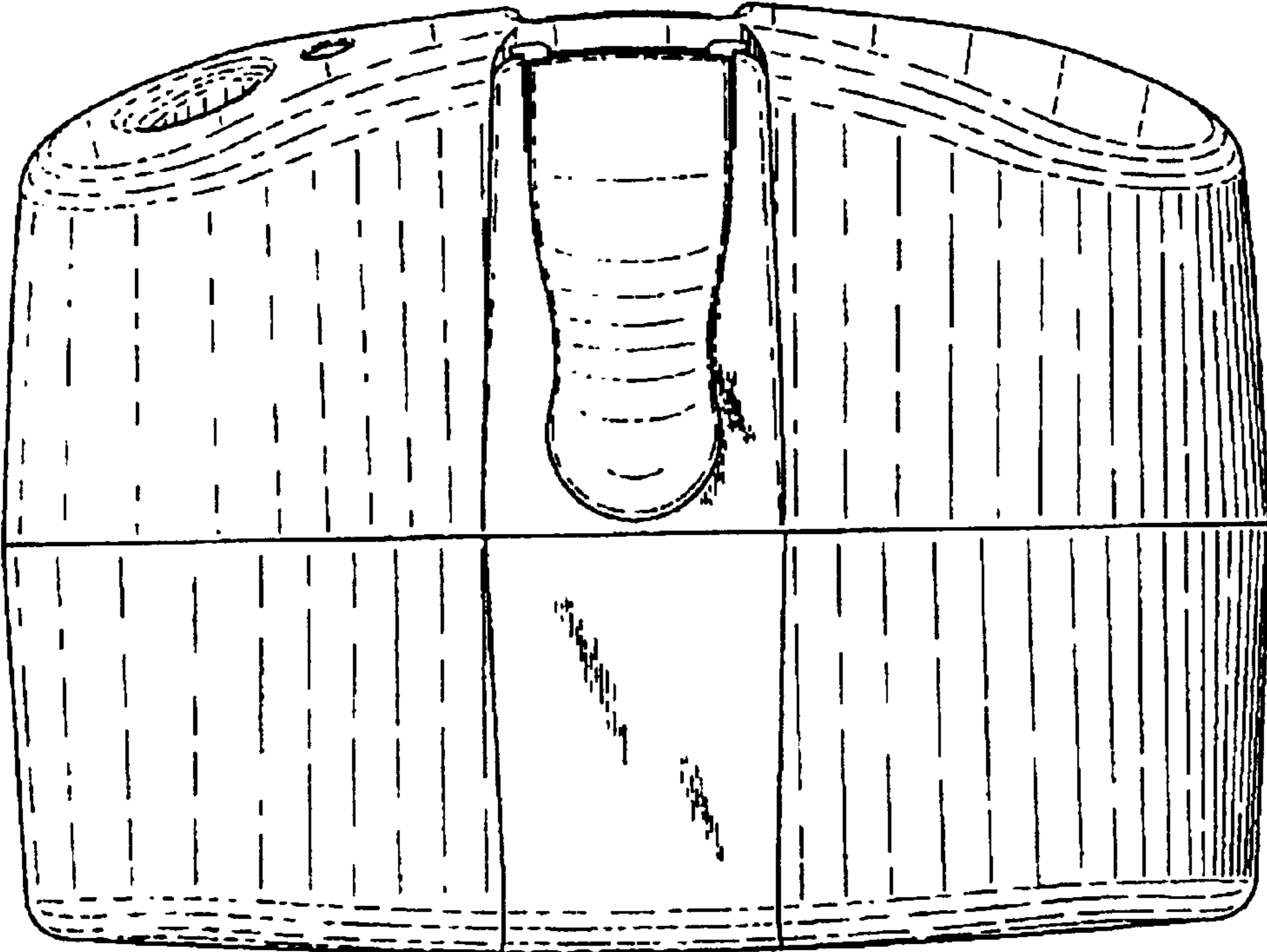

Fig. 4

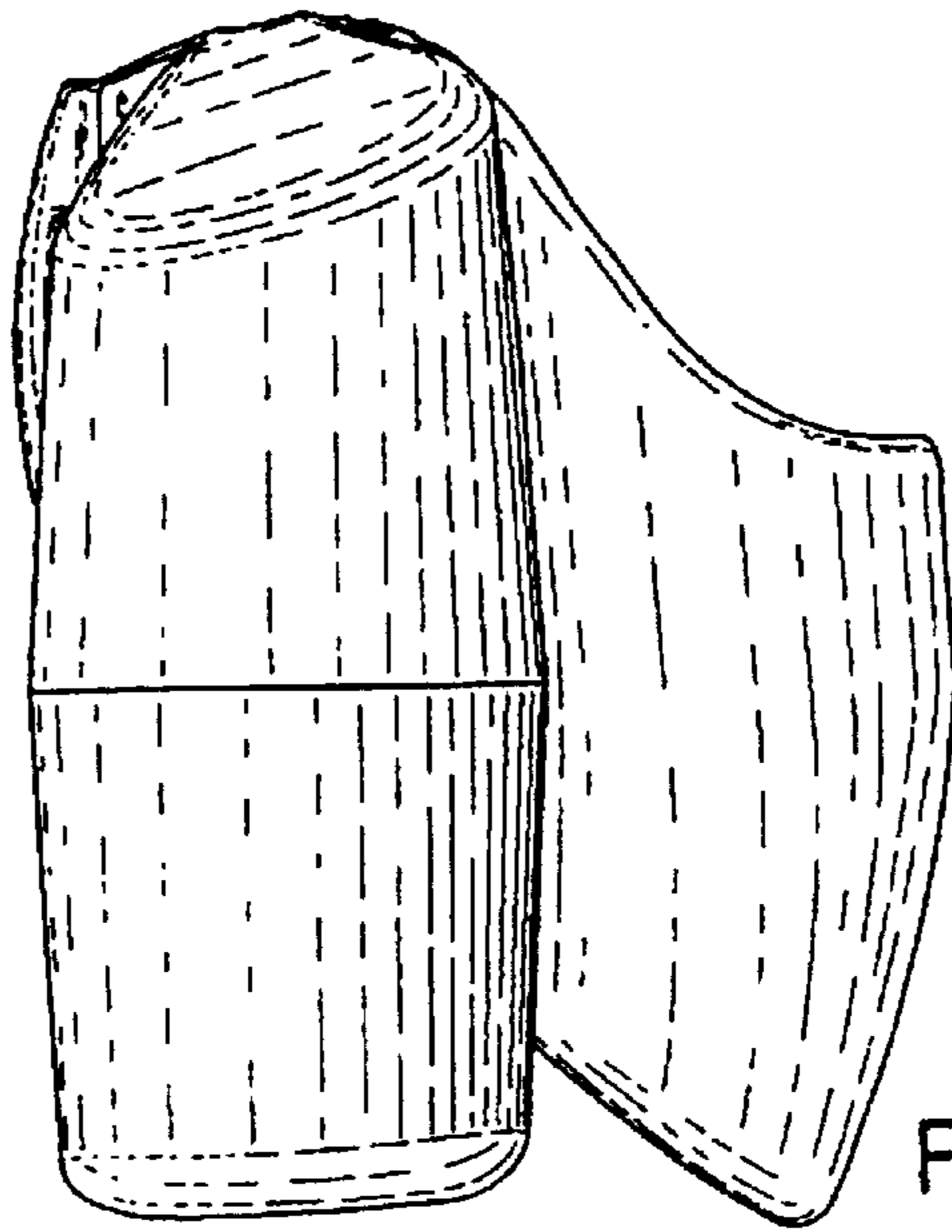

Fig. 5

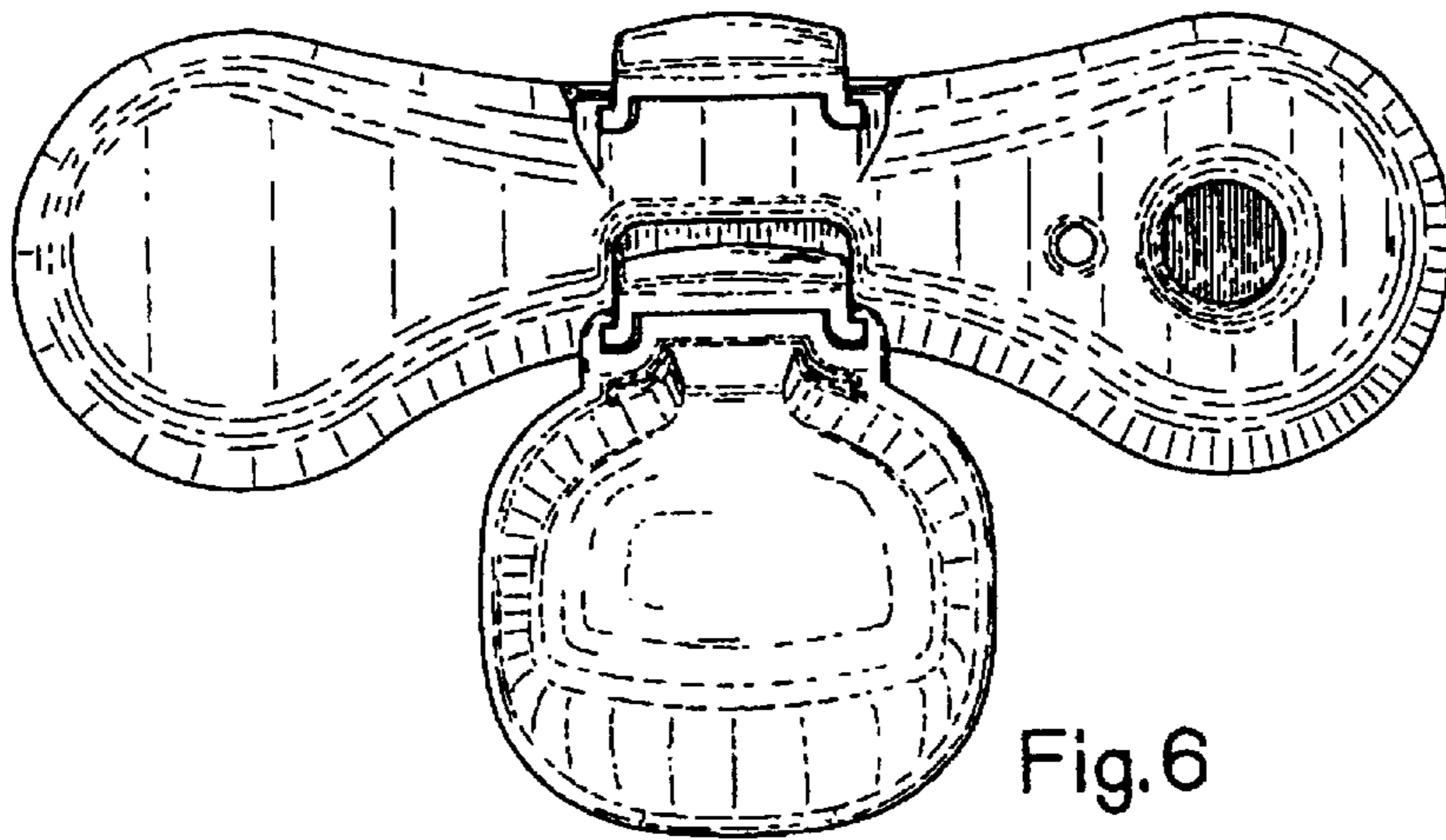

Fig. 6

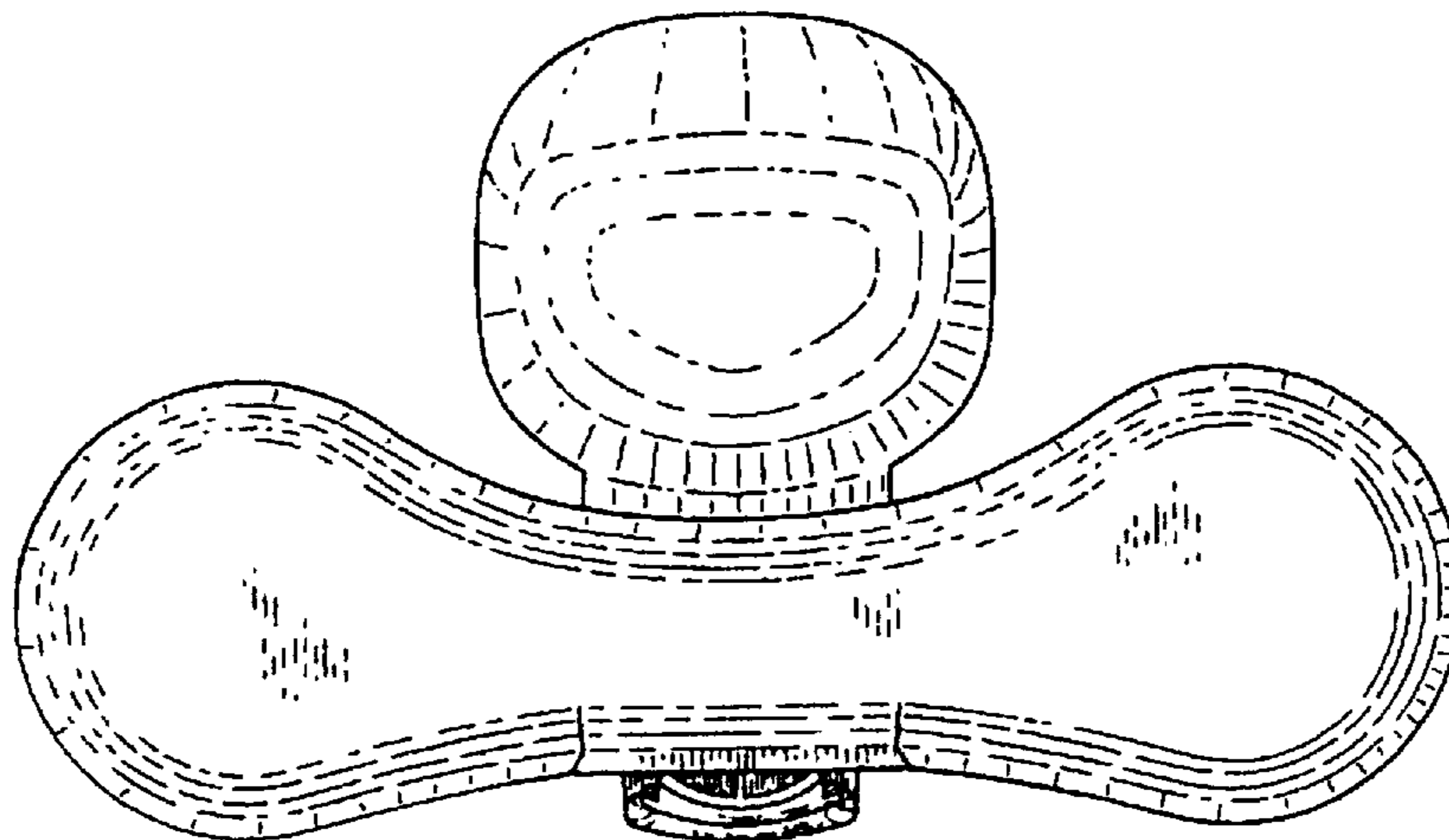

Fig. 7

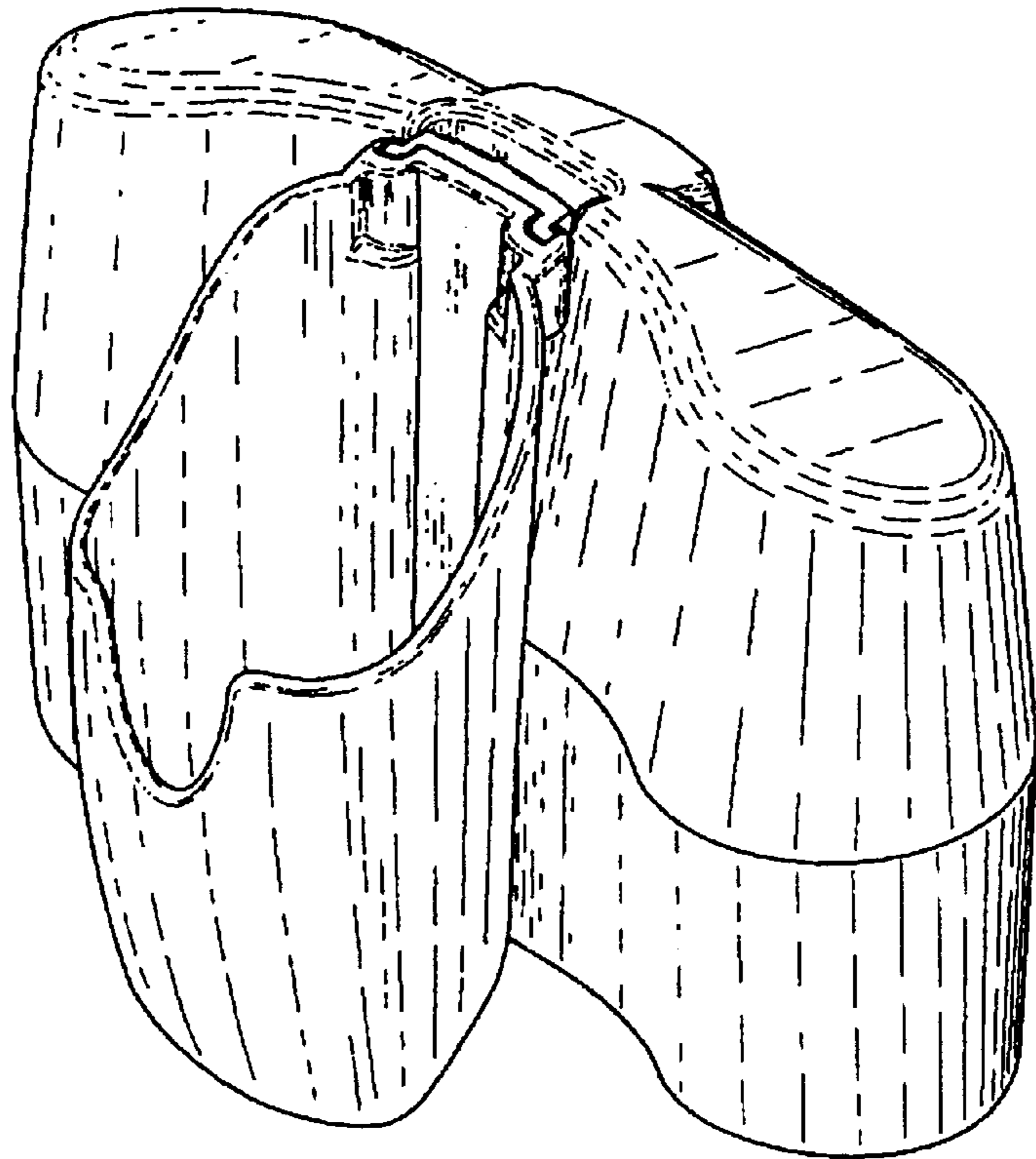

Fig. 8

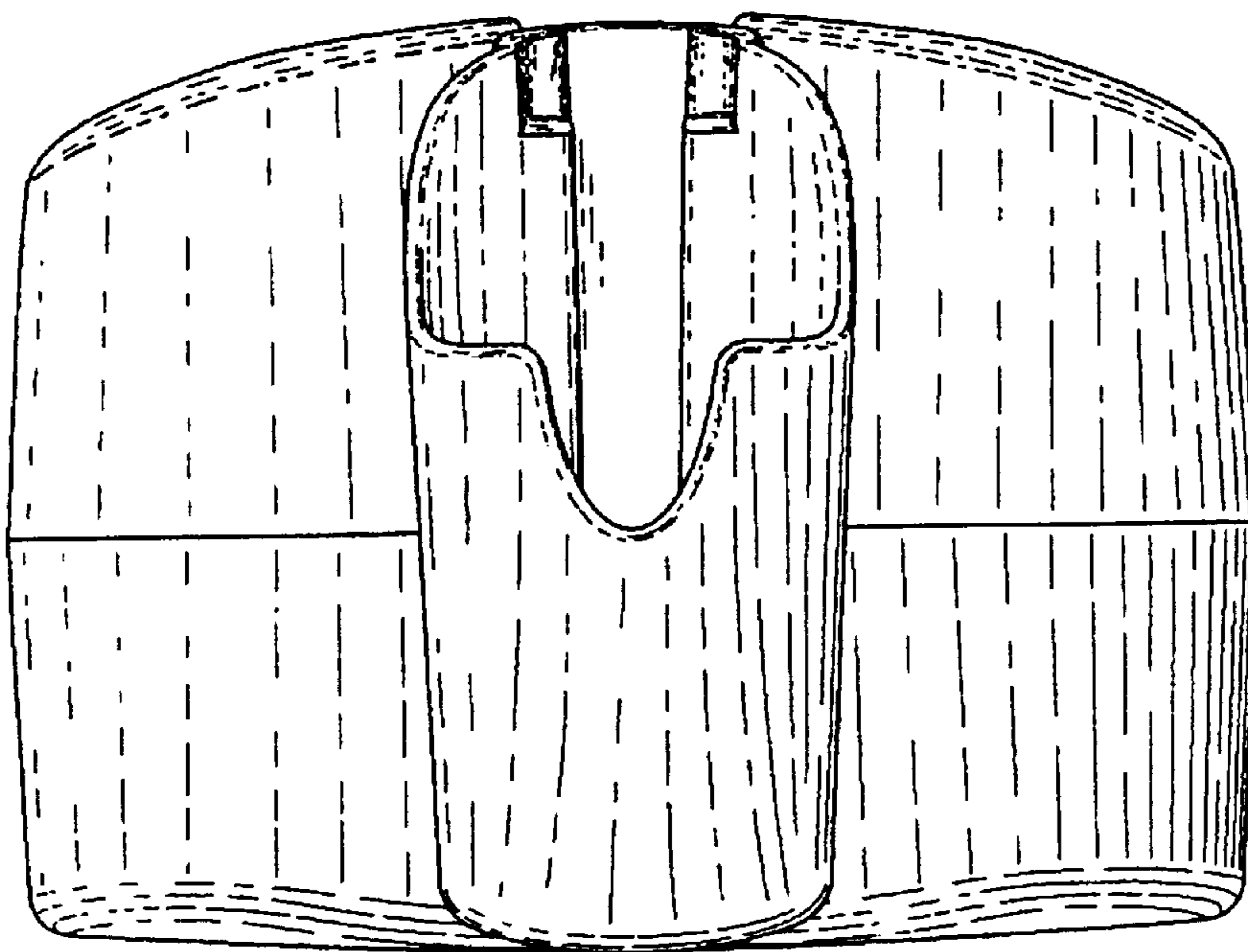

Fig. 9

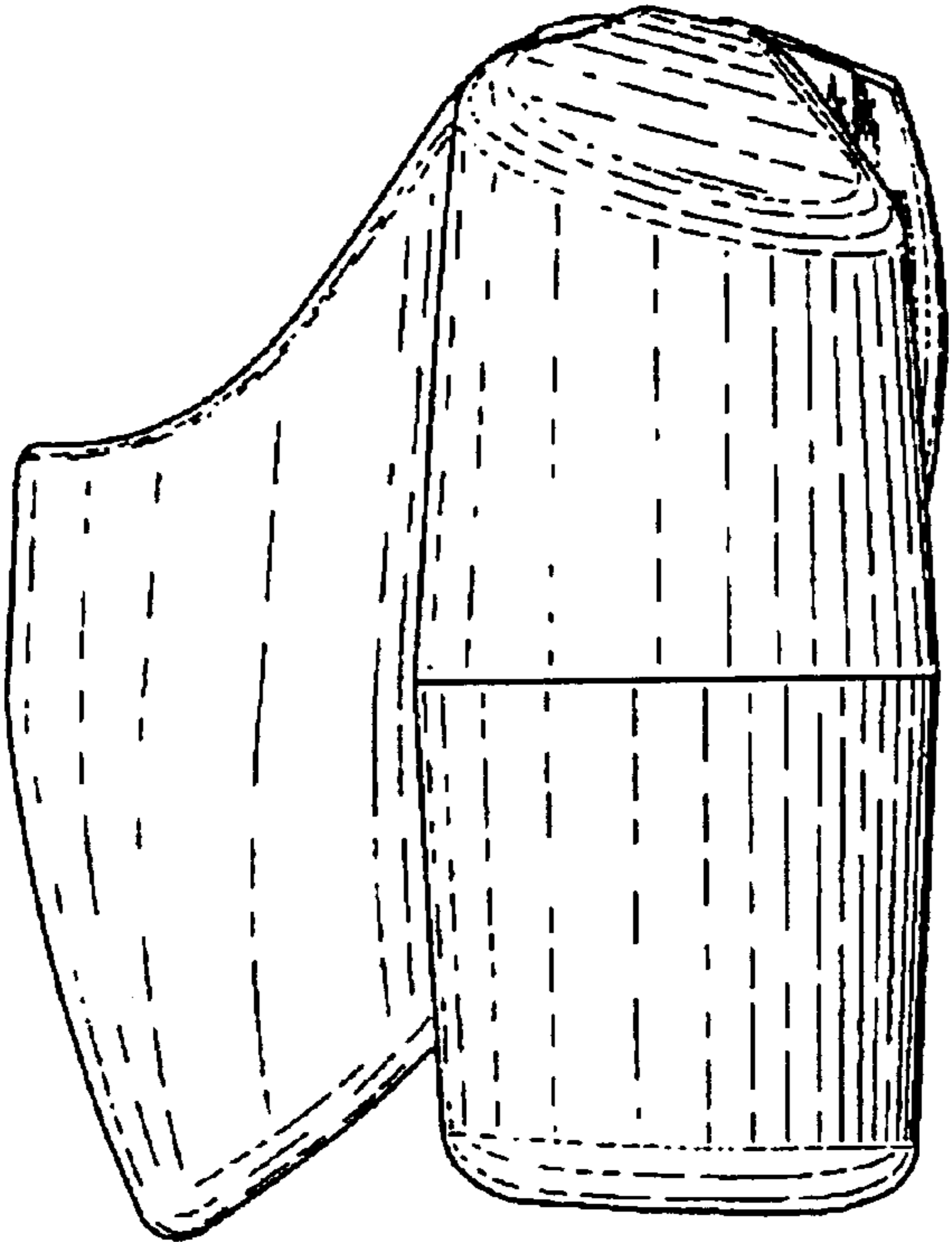

Fig.10

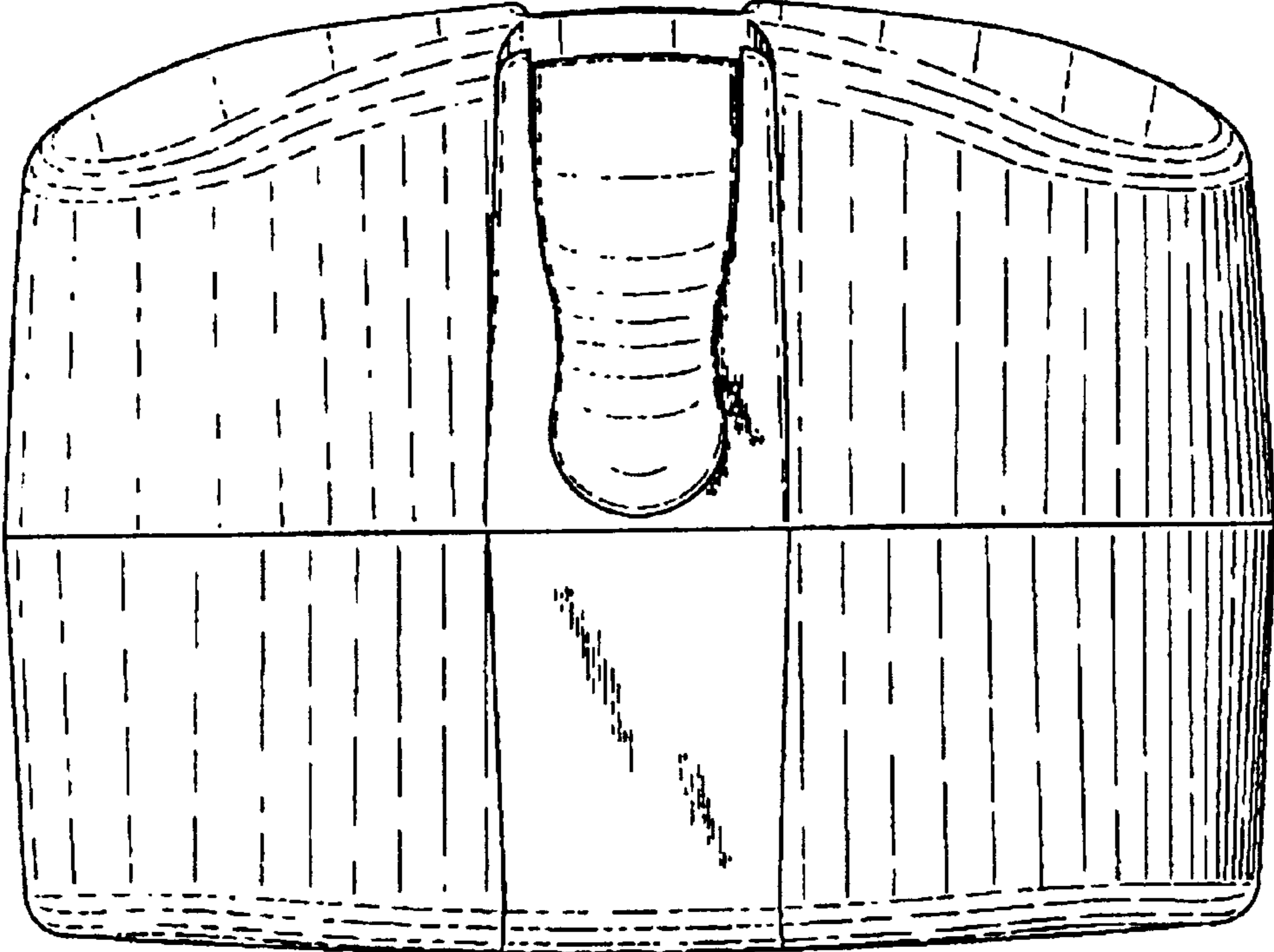

Fig.11

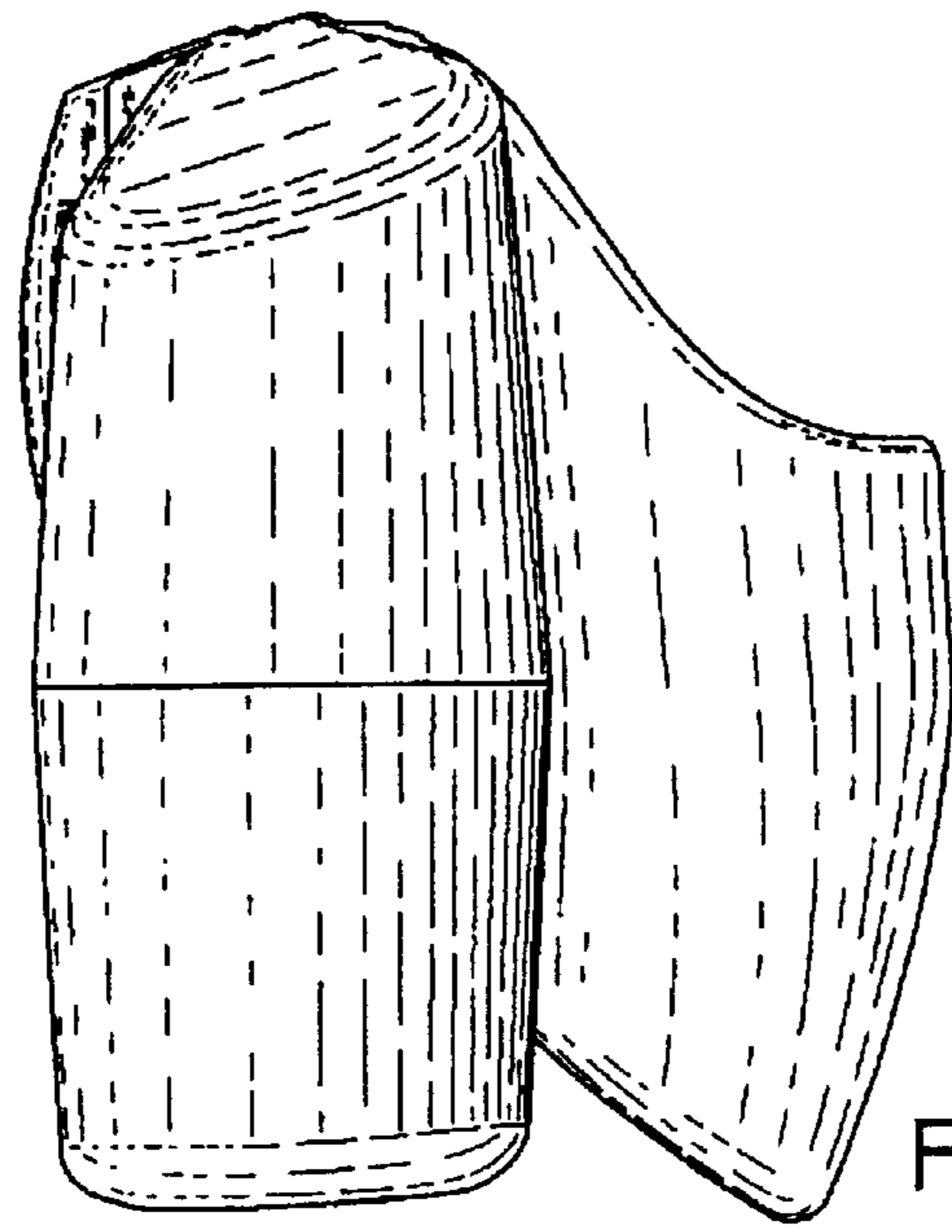

Fig.12

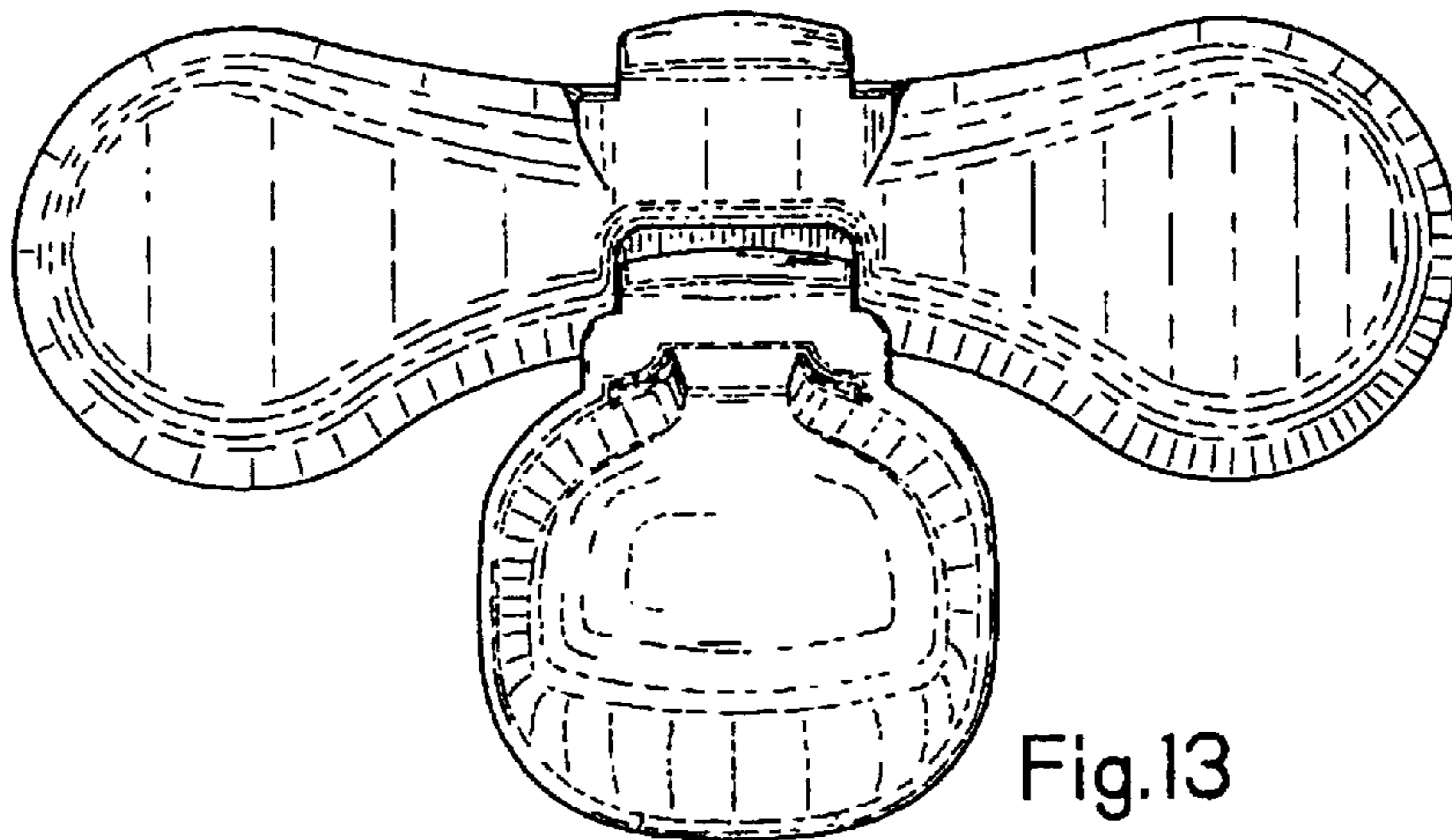

Fig.13

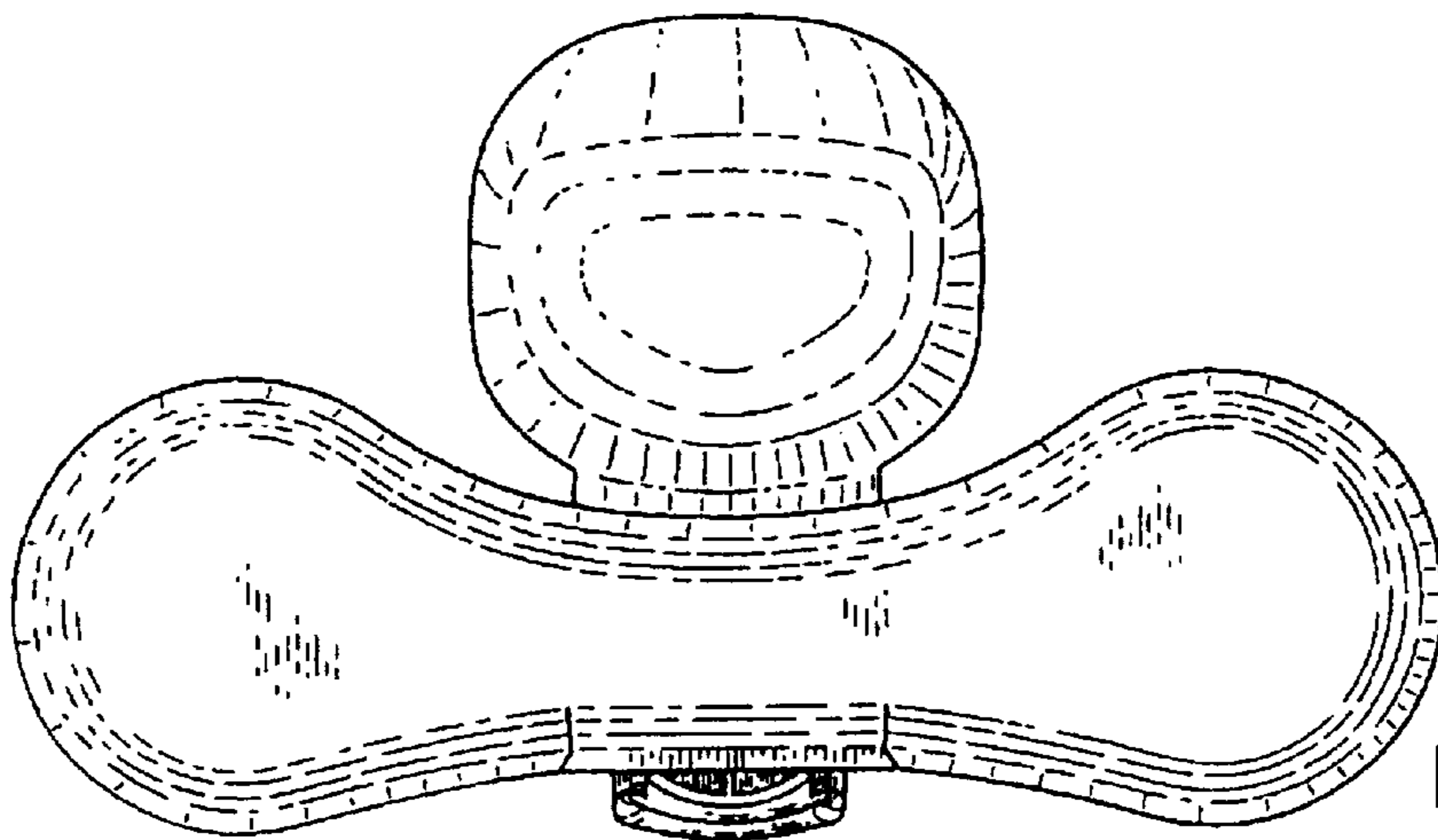

Fig.14