



US00D514720S

(12) **United States Design Patent**
Sze-Tai

(10) **Patent No.:** **US D514,720 S**
(45) **Date of Patent:** **** Feb. 7, 2006**

(54) **SPOTLIGHT**

(75) **Inventor:** **Yung Sze-Tai**, Kowloon (HK)

(73) **Assignee:** **AK Industrial Co., Ltd.**, Hong Kong (HK)

(**) **Term:** **14 Years**

(21) **Appl. No.:** **29/218,328**

(22) **Filed:** **Dec. 1, 2004**

Related U.S. Application Data

(63) Continuation-in-part of application No. 29/187,298, filed on Jul. 30, 2003.

(51) **LOC (8) Cl.** **26-02**

(52) **U.S. Cl.** **D26/42**

(58) **Field of Classification Search** D26/37-50;
362/157, 158, 171-174, 183-208

See application file for complete search history.

(56) **References Cited**

U.S. PATENT DOCUMENTS

D418,237 S 12/1999 Yuen

D426,006 S * 5/2000 Yuen D26/42

D432,691 S 10/2000 Meoli, Jr.

D440,334 S * 4/2001 Yuen D26/42

D445,207 S 7/2001 Yuen

D463,592 S * 9/2002 Han-Shim D26/42

* cited by examiner

Primary Examiner—Marcus A. Jackson

(74) *Attorney, Agent, or Firm*—Roy, Kiesel, Keegan & DeNicola

(57) **CLAIM**

The ornamental design for a spotlight, as shown and described.

DESCRIPTION

FIG. 1 is a top view of the spotlight incorporating the inventive design.

FIG. 2 is a right side view of the spotlight of FIG. 1.

FIG. 3 is a bottom view of the spotlight of FIG. 1.

FIG. 4 is a back view of the spotlight of FIG. 1.

FIG. 5 is a front view of the spotlight of FIG. 1.

FIG. 6 is a left side view of the spotlight of FIG. 1; and,

FIG. 7 is a perspective view of the spotlight of FIG. 1.

1 Claim, 7 Drawing Sheets

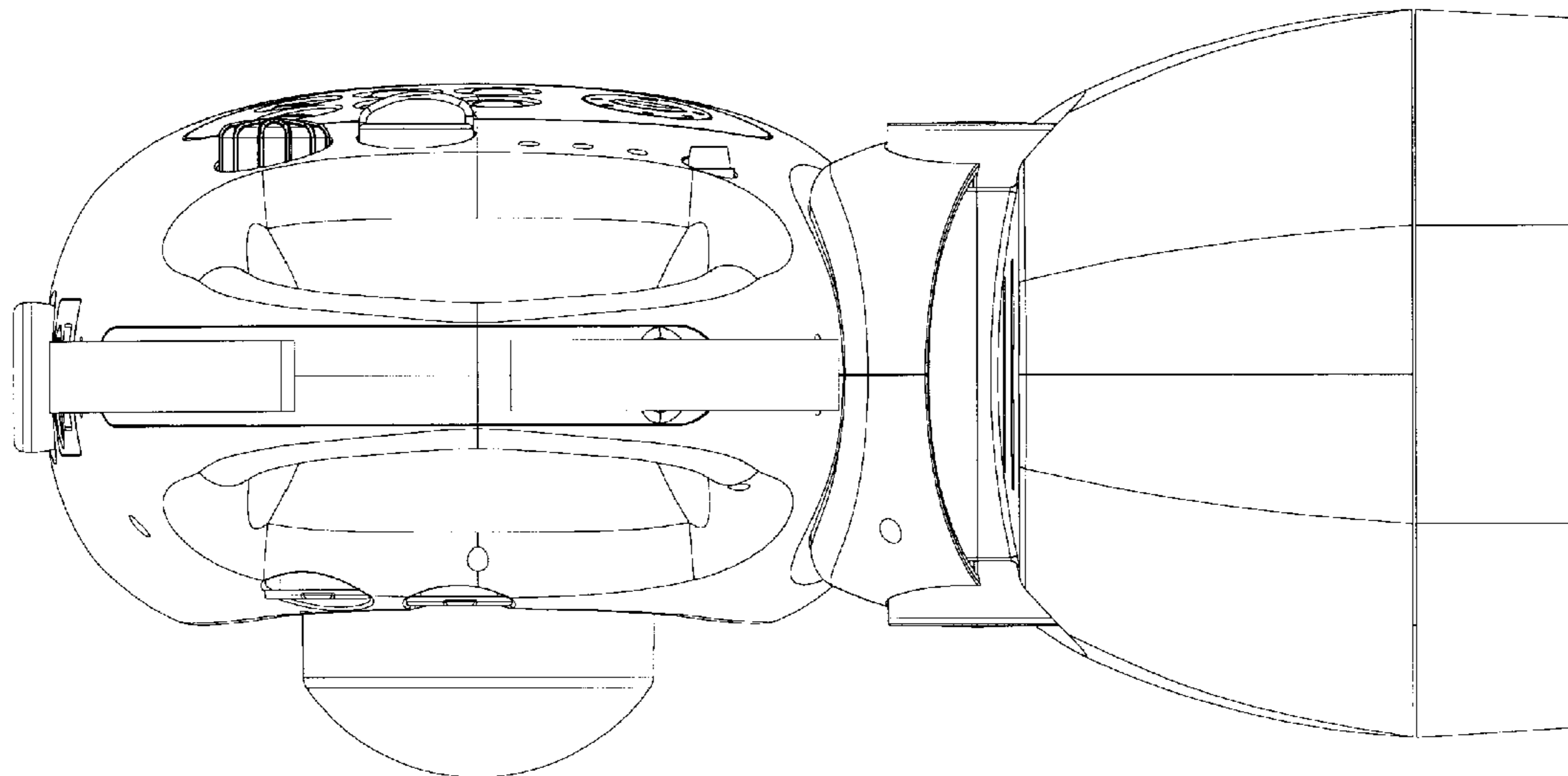

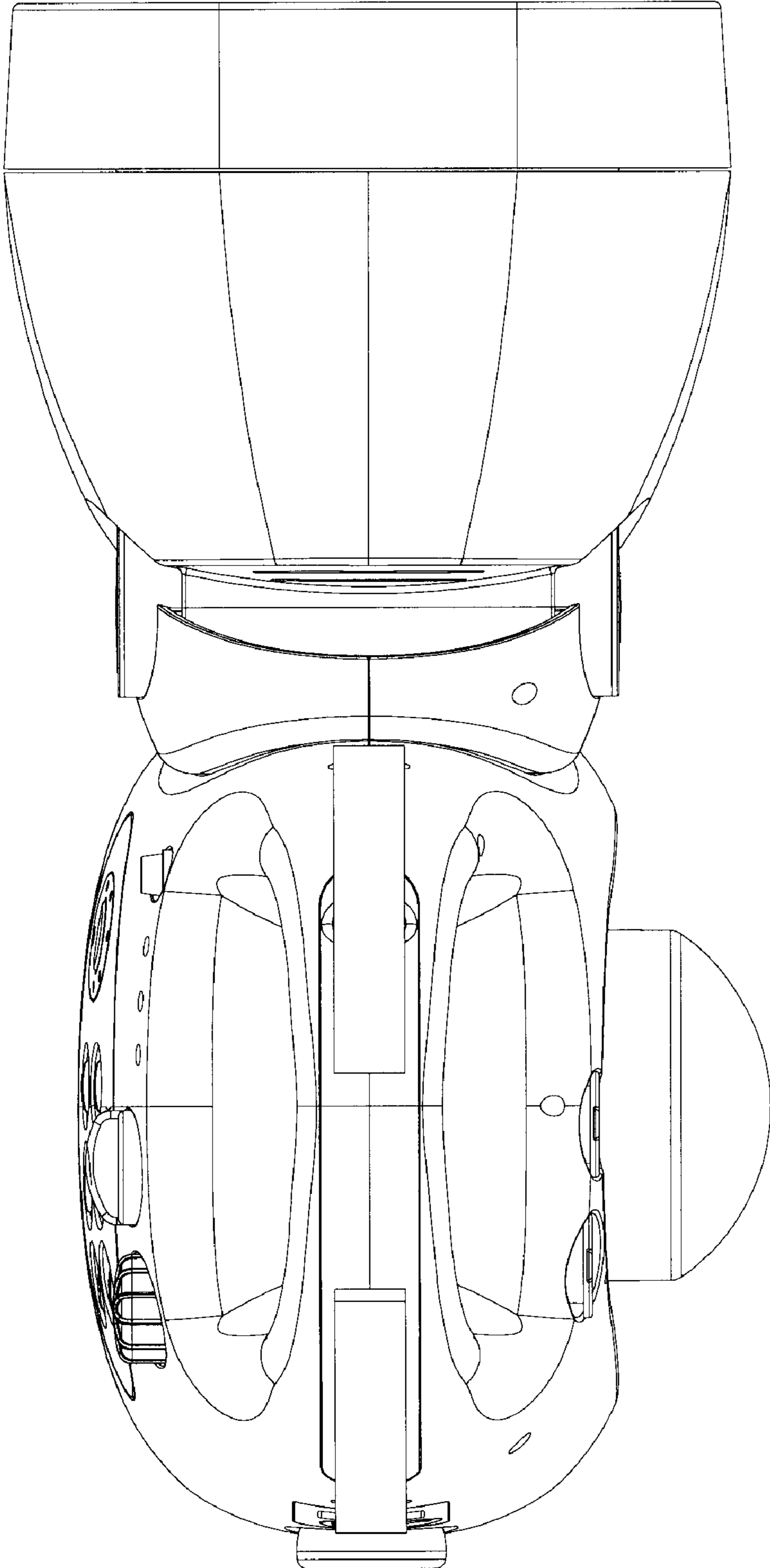

Fig1

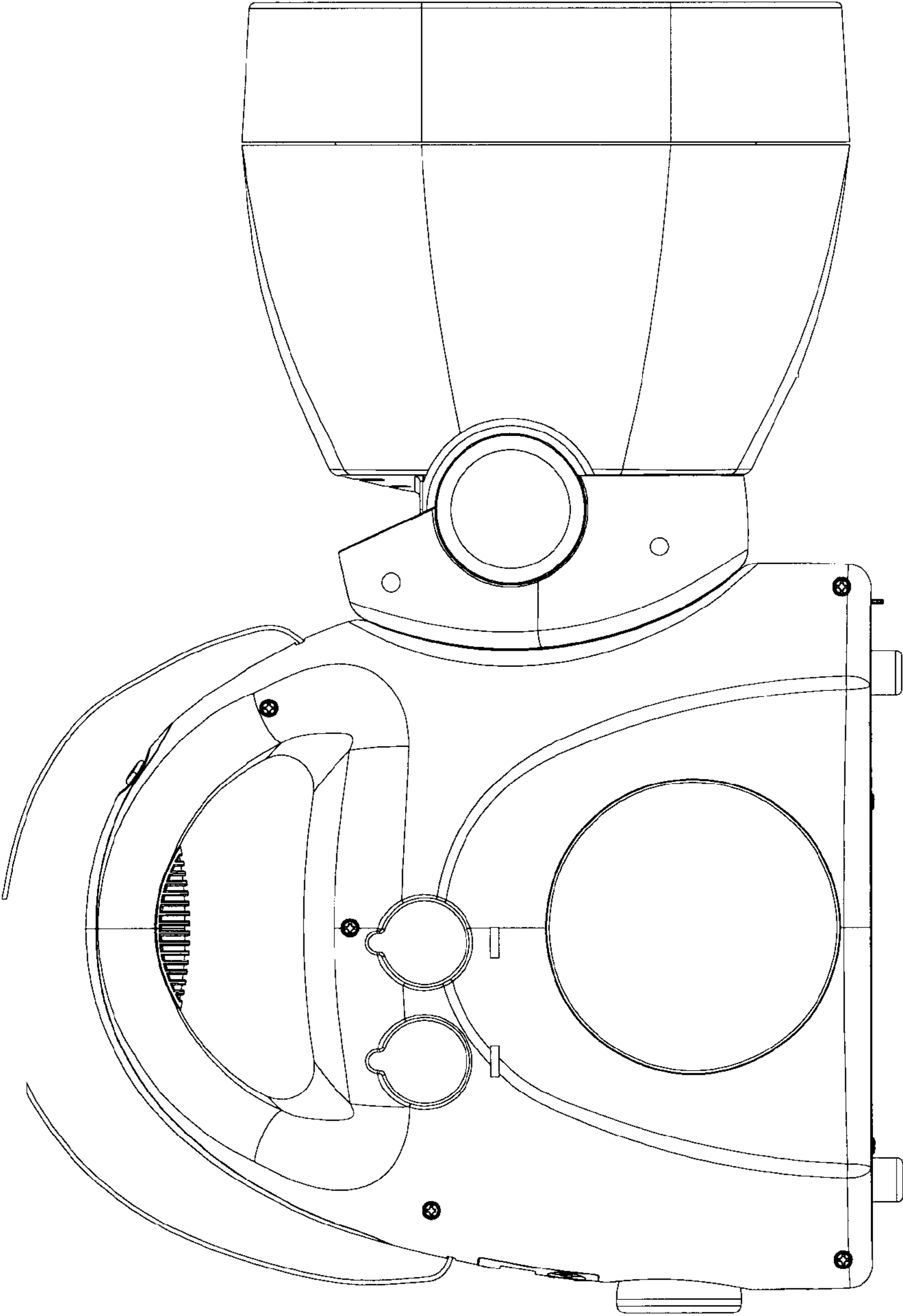

Fig2

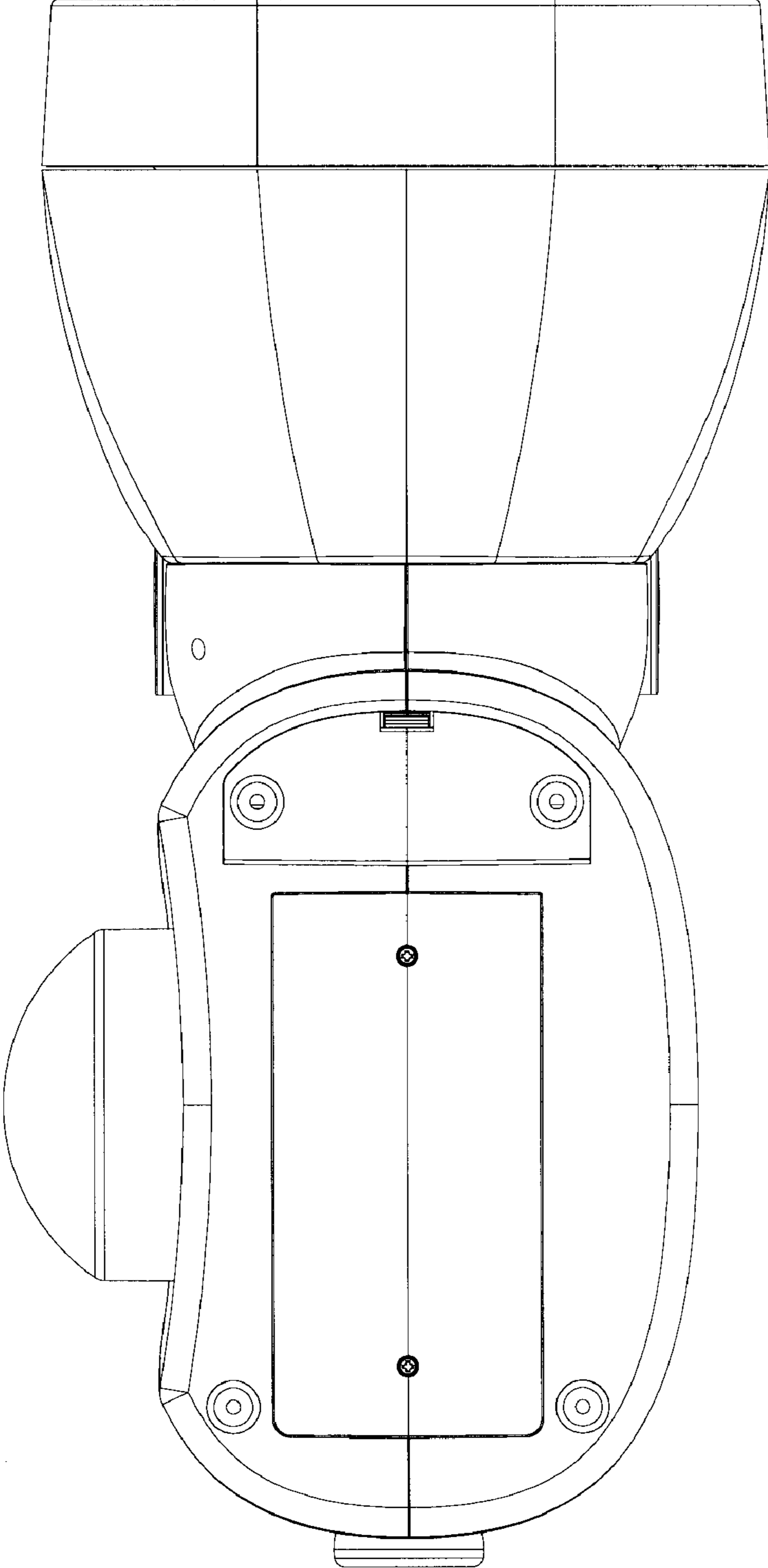

Fig3

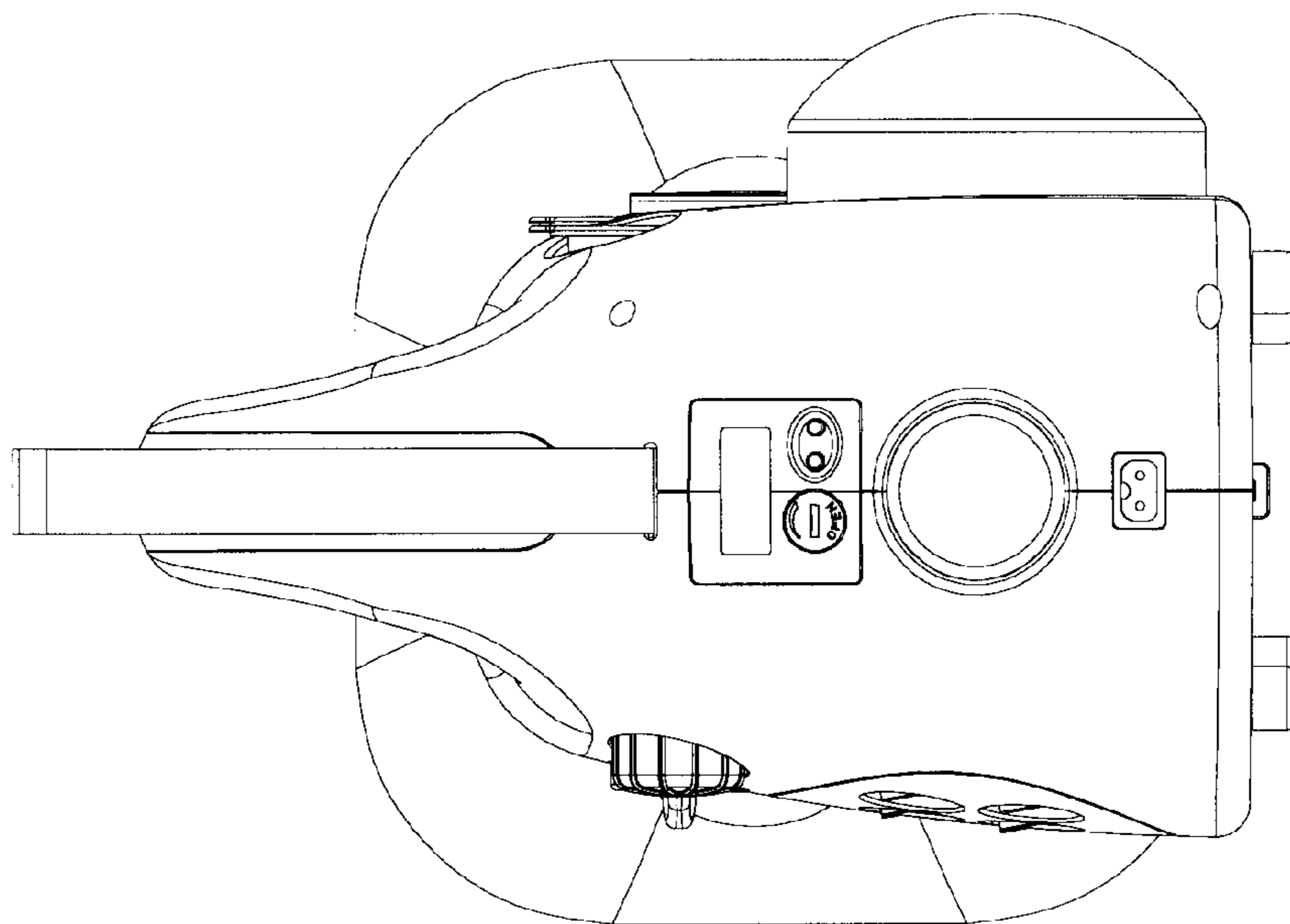

Fig4

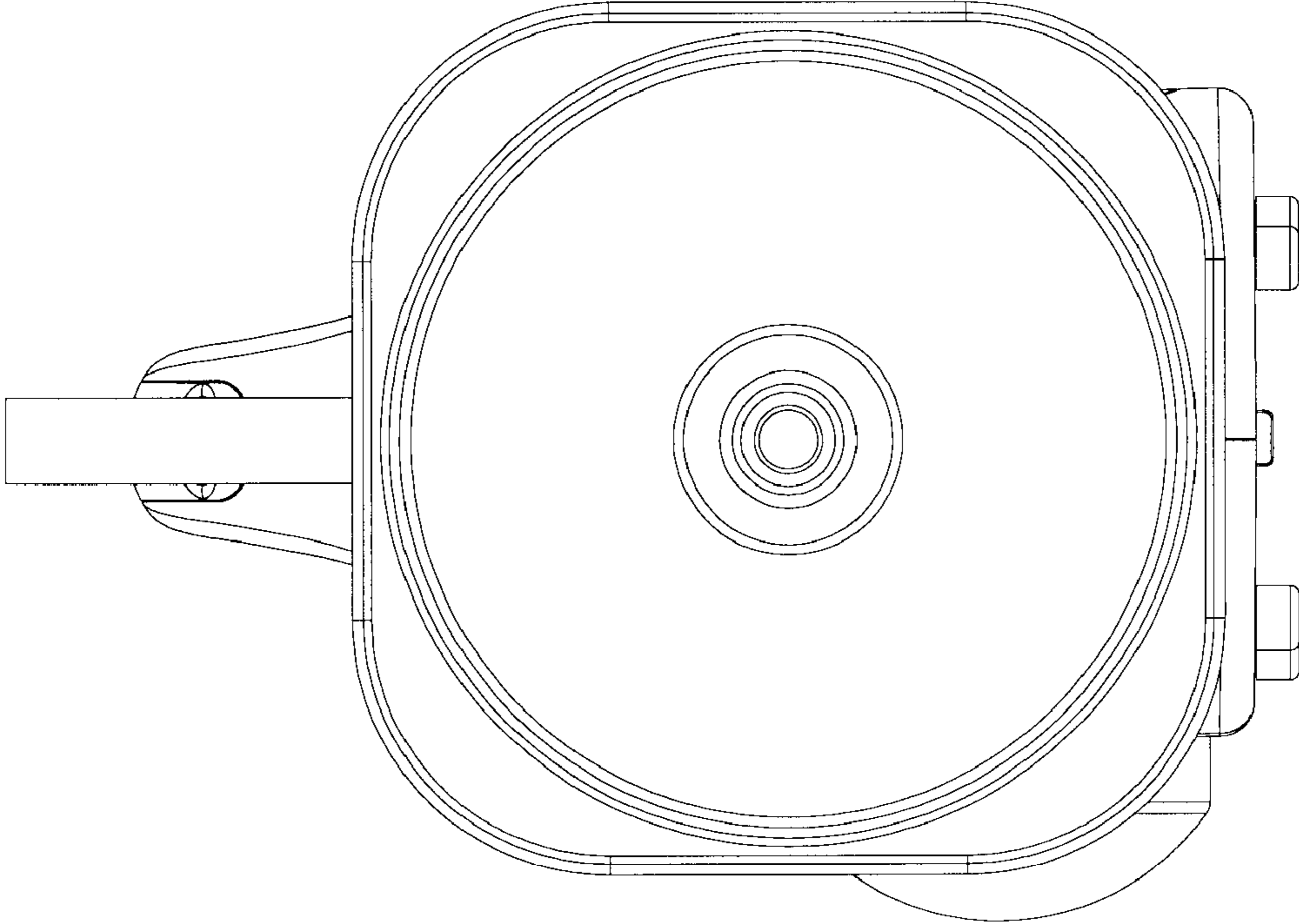

Fig5

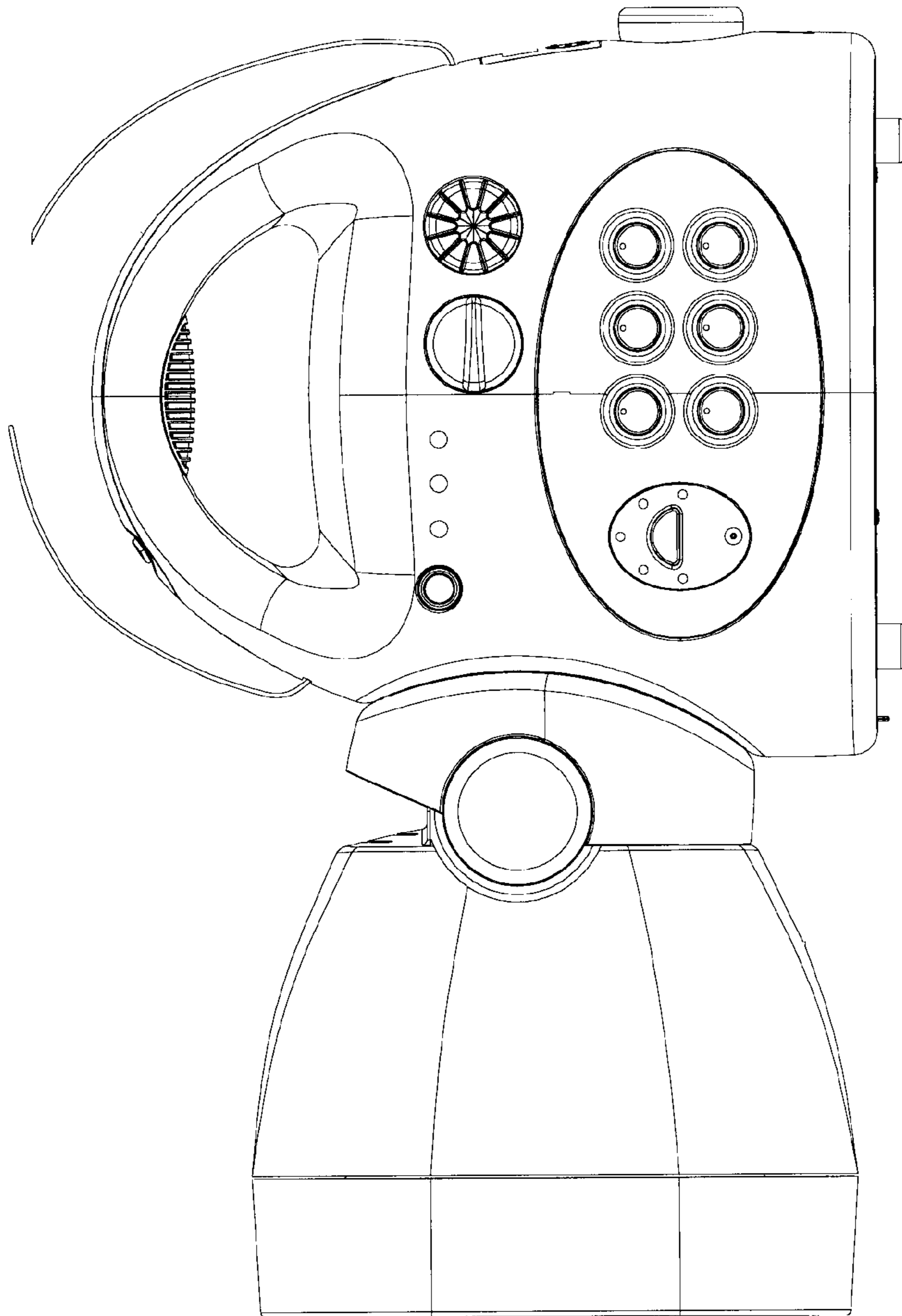

Fig 6

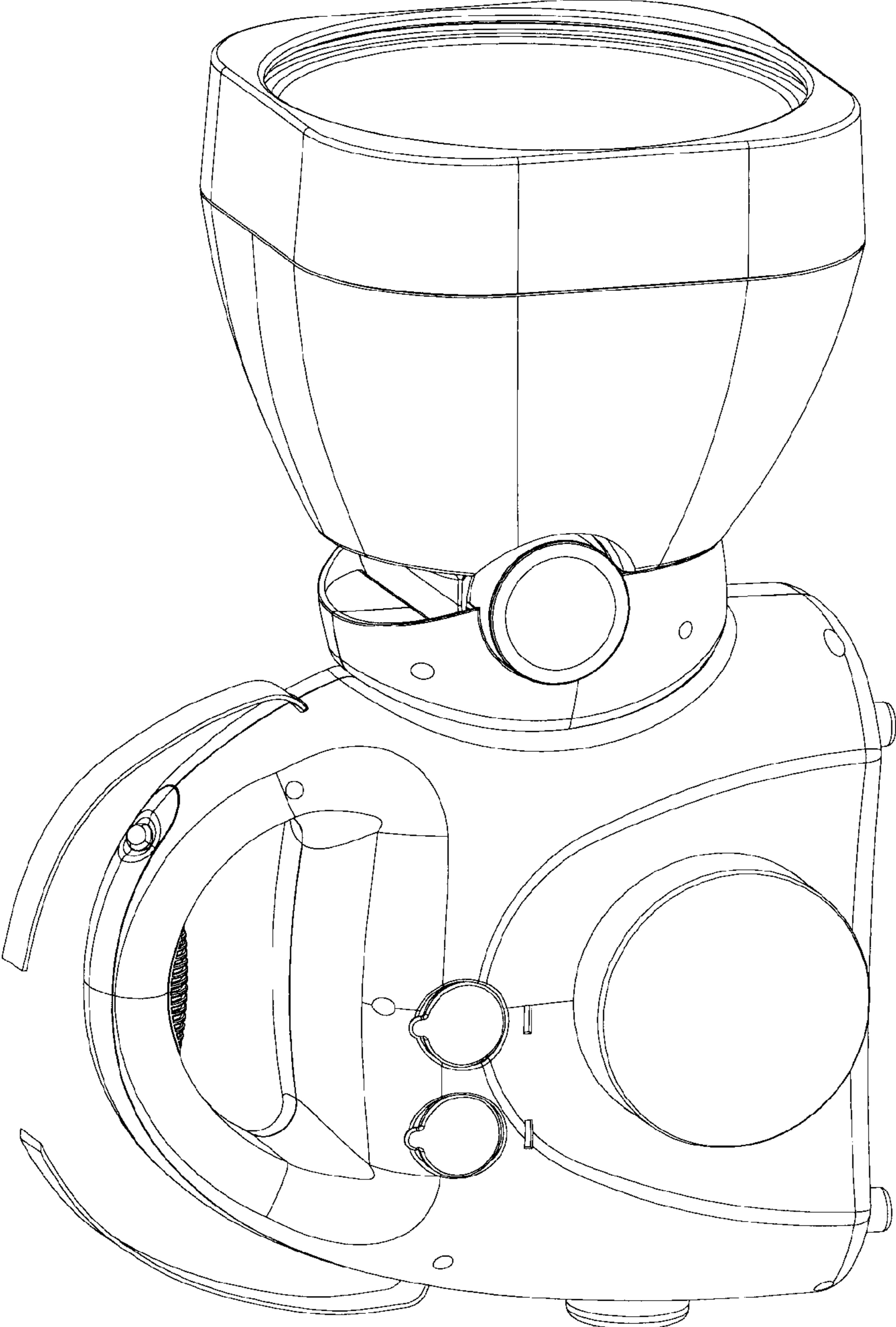

Fig7