



US00D514670S

(12) United States Design Patent
Handley

(10) Patent No.: US D514,670 S
(45) Date of Patent: ** Feb. 7, 2006

(54) DOWNSPOUT EXTENSION
(75) Inventor: Stephen Handley, Barrie (CA)
(73) Assignee: GSW Inc., Oakville (CA)
() Term: 14 Years**
(21) Appl. No.: 29/197,583
(22) Filed: Jan. 20, 2004
(51) LOC (8) Cl. 23-01
(52) U.S. Cl. D23/267
(58) Field of Classification Search D23/267,
D23/266; 52/16; 137/615; 138/119
See application file for complete search history.

(56) References Cited
U.S. PATENT DOCUMENTS
3,076,669 A * 2/1963 Schlein 285/179
5,673,519 A * 10/1997 McCaughan 52/16
5,813,701 A * 9/1998 Noble 285/4

5,915,735 A * 6/1999 Noble 285/4
6,041,825 A * 3/2000 Smith et al. 138/109
6,223,777 B1 * 5/2001 Smith et al. 138/109

* cited by examiner
Primary Examiner—Robin V. Taylor

(57) CLAIM

An ornamental design for a downspout extension, as shown.

DESCRIPTION

FIG. 1 is a perspective view of the downspout extension;
FIG. 2 is a right side view of the downspout extension;
FIG. 3 is a top view of the downspout extension;
FIG. 4 is a left side view of the downspout extension;
FIG. 5 is a bottom view of the downspout extension;
FIG. 6 is an enlarged left end view of the downspout extension; and,
FIG. 7 is an enlarged right end view of the downspout extension.

1 Claim, 3 Drawing Sheets

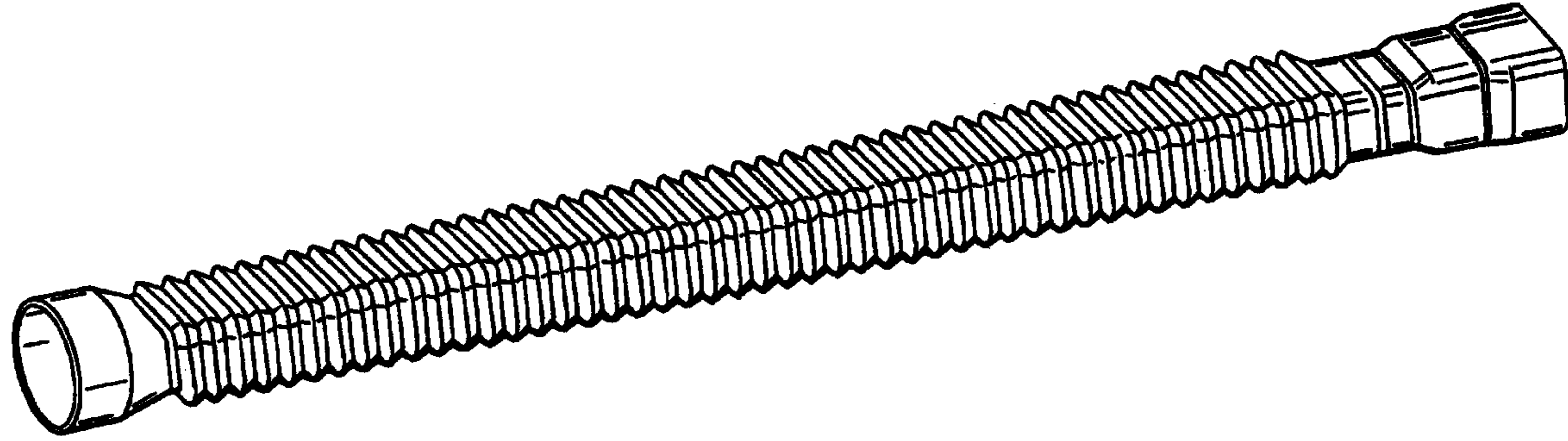

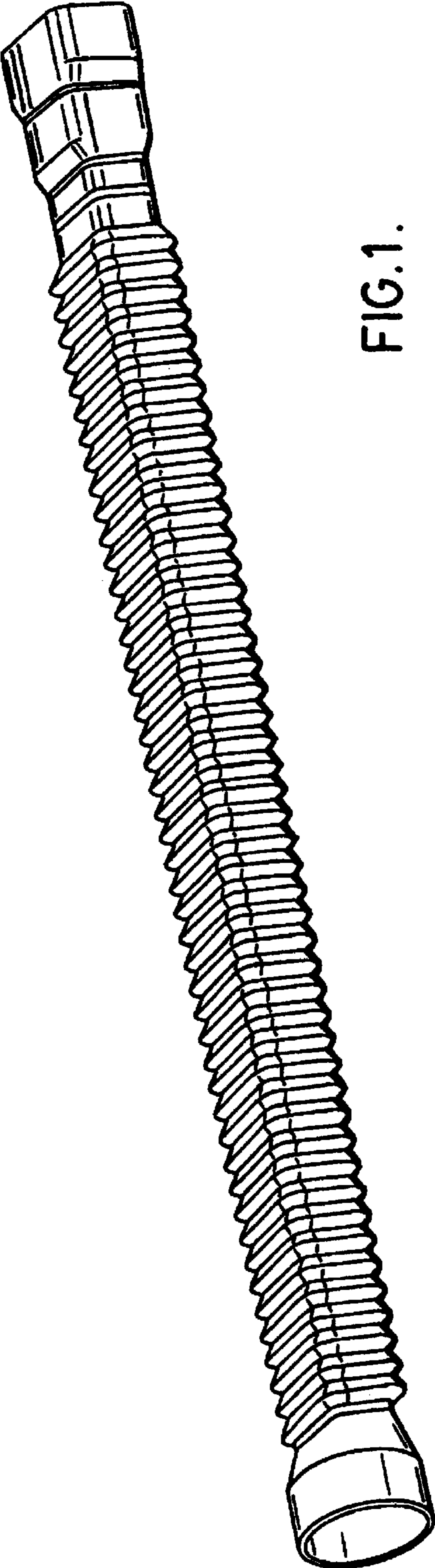

FIG. 1.

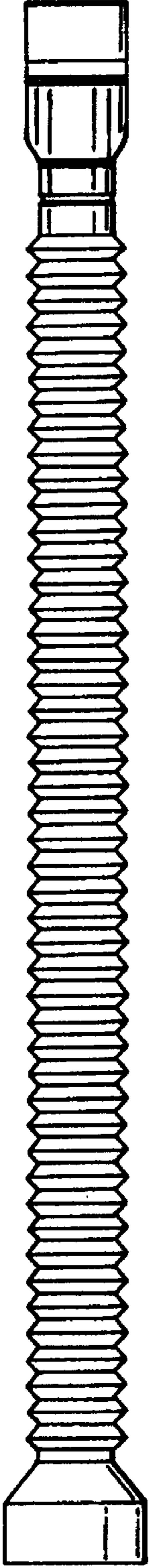

FIG. 2.

FIG. 3.

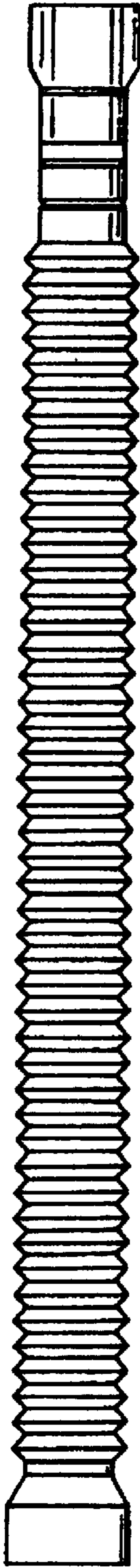

FIG. 4.

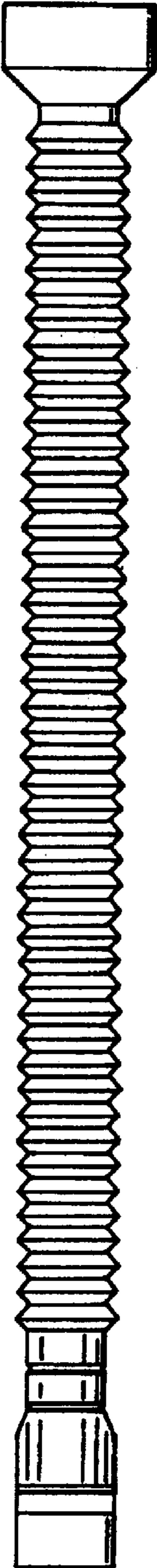
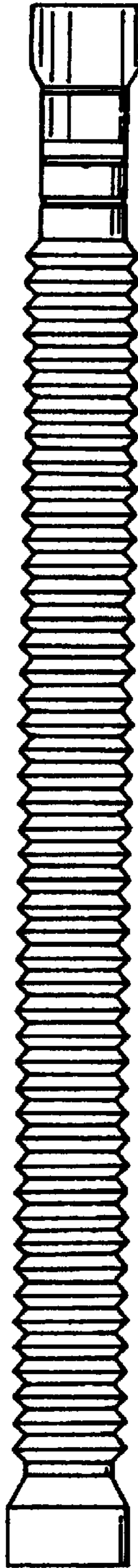

FIG. 5.



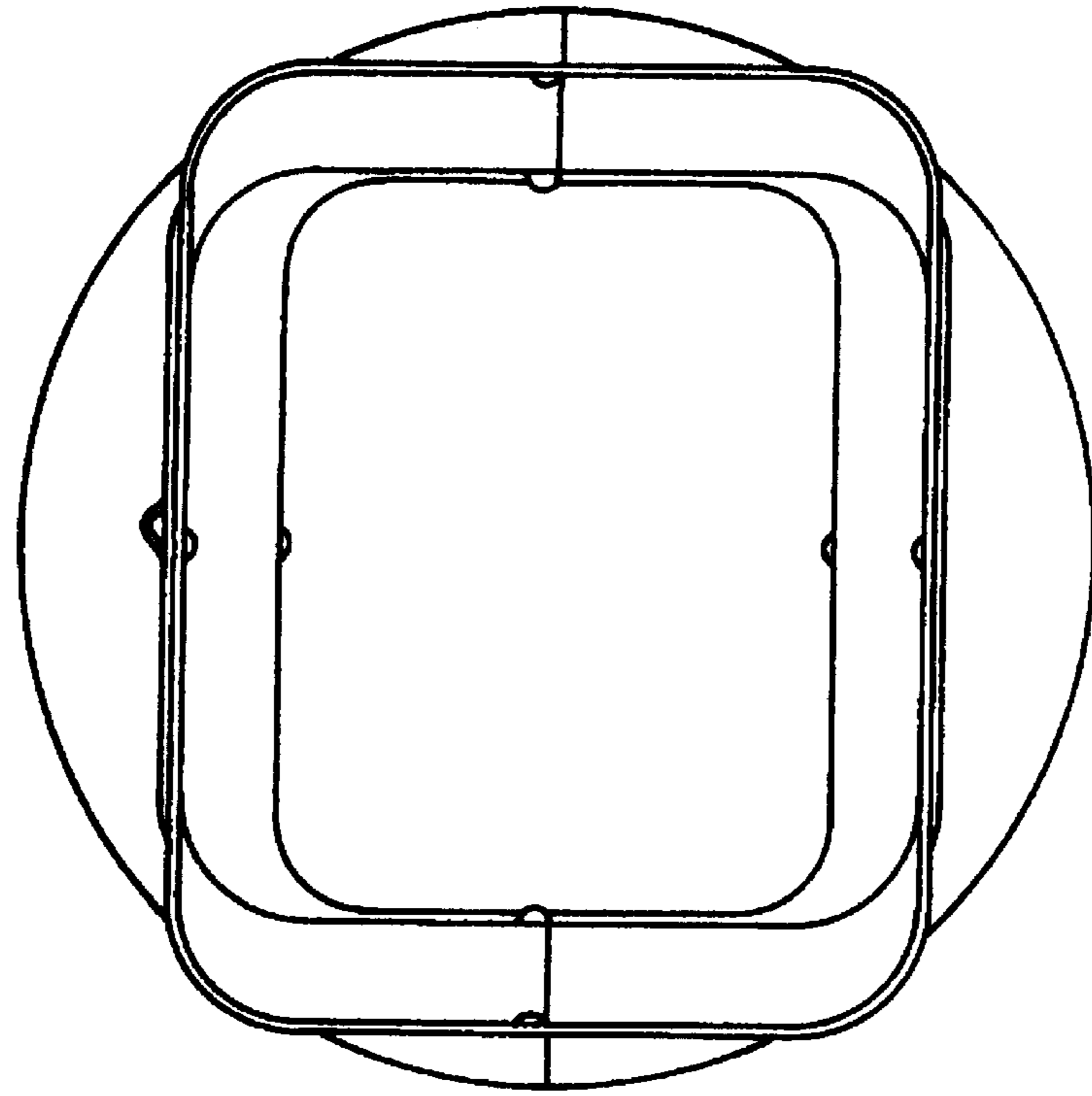

FIG. 7.

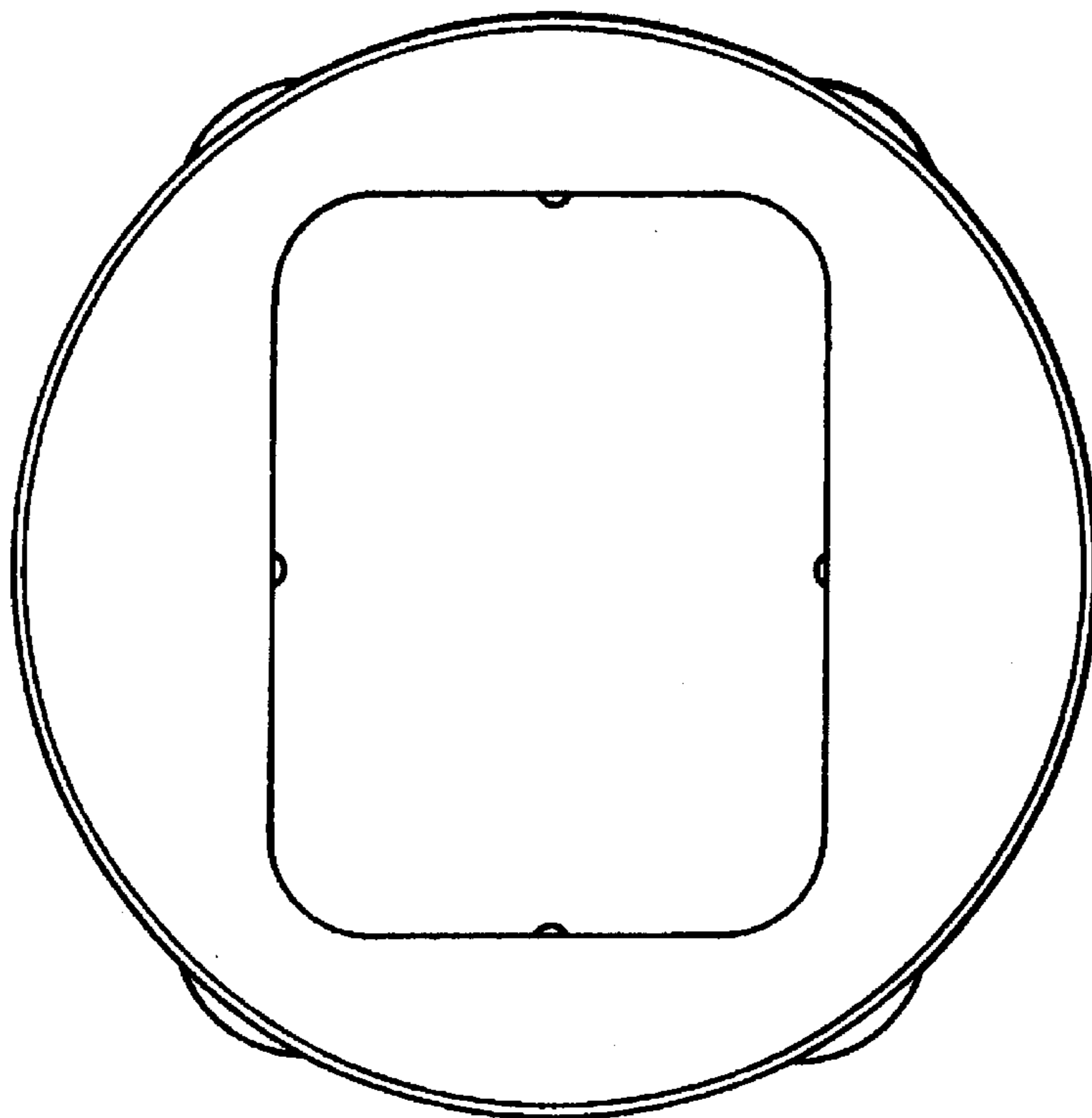

FIG. 6.