



US00D514572S

(12) **United States Design Patent**
Chang

(10) **Patent No.:** **US D514,572 S**

(45) **Date of Patent:** **** Feb. 7, 2006**

(54) **WIRELESS MOUSE**

(76) **Inventor:** **Yuan-Jung Chang**, 4F, No. 228, Min An Rd., Hsinchuang City, Taipei Hsien (TW)

(**) **Term:** **14 Years**

(21) **Appl. No.:** **29/220,561**

(22) **Filed:** **Jan. 4, 2005**

(51) **LOC (8) Cl.** **14-02**

(52) **U.S. Cl.** **D14/409; D14/405**

(58) **Field of Classification Search** D14/402-410, D14/417, 432; 200/5 R, 5 A, 6 R, 6 A; 273/148 B; 345/156-167; 74/471 XY; 463/36-38
See application file for complete search history.

(56) **References Cited**

U.S. PATENT DOCUMENTS

4,862,165 A	*	8/1989	Gart	341/20
D350,737 S	*	9/1994	Chen	D14/409
D354,746 S	*	1/1995	Colani et al.	D14/409
D418,501 S	*	1/2000	Neifer	D14/409
6,266,047 B1	*	7/2001	Benja-Athon	345/163

D461,188 S	*	8/2002	Lo	D14/409
D464,352 S	*	10/2002	Kerestegian	D14/408
D464,651 S	*	10/2002	Kerestegian	D14/402
6,580,419 B1	*	6/2003	O’Keeffe et al.	345/163
D486,490 S	*	2/2004	Hada	D14/409
D493,173 S	*	7/2004	Canavan et al.	D14/408

* cited by examiner

Primary Examiner—Pamela Burgess

(74) *Attorney, Agent, or Firm*—Rosenberg, Klein & Lee

(57) **CLAIM**

The ornamental design for a “wireless mouse,” as shown and described.

DESCRIPTION

FIG. 1 is a perspective view of a “wireless mouse” showing my new design;

FIG. 2 is a front view thereof;

FIG. 3 is a rear view thereof;

FIG. 4 is a left side view thereof;

FIG. 5 is a right side view thereof;

FIG. 6 is a top view thereof; and,

FIG. 7 is a bottom view thereof.

1 Claim, 4 Drawing Sheets

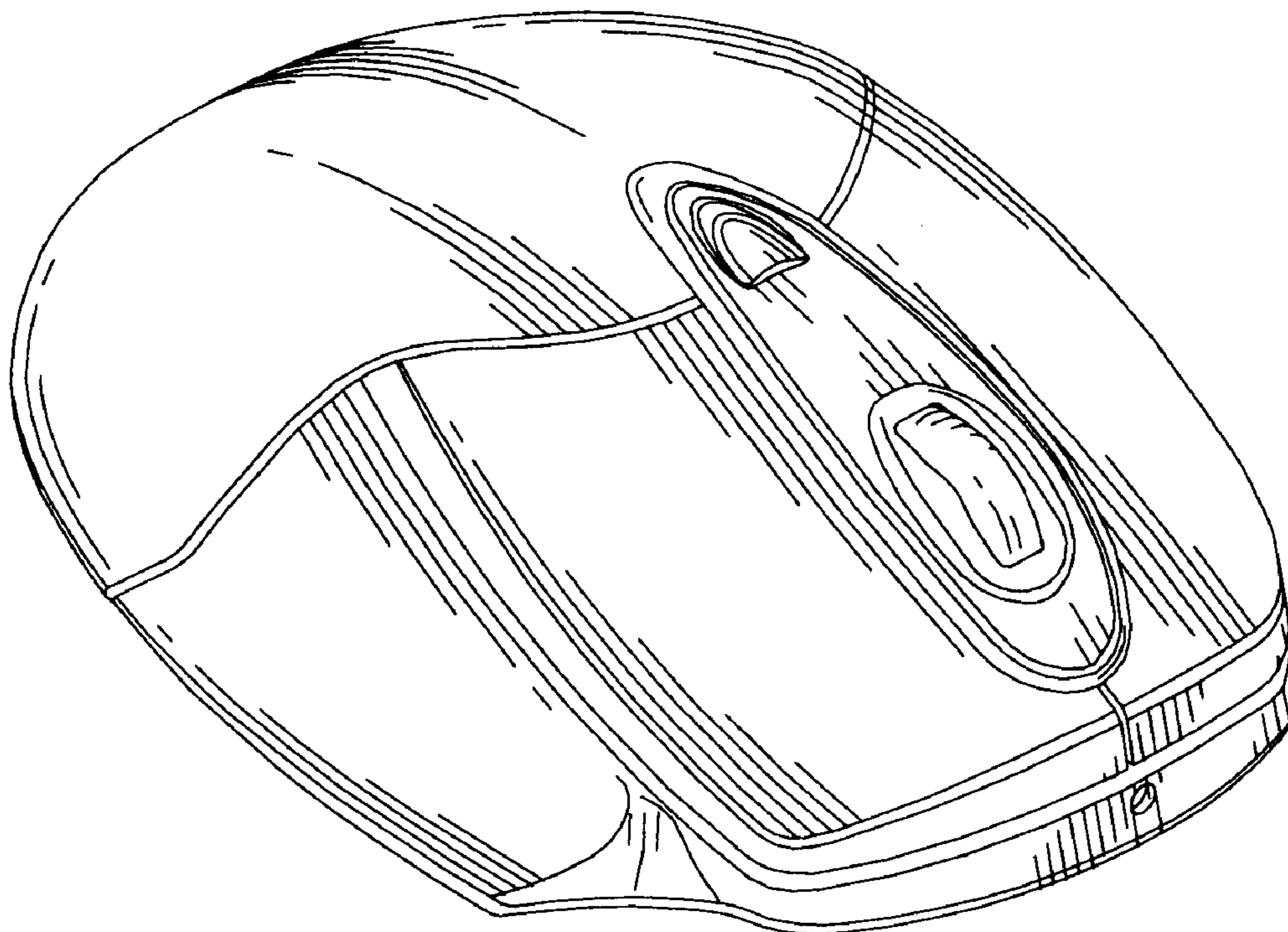

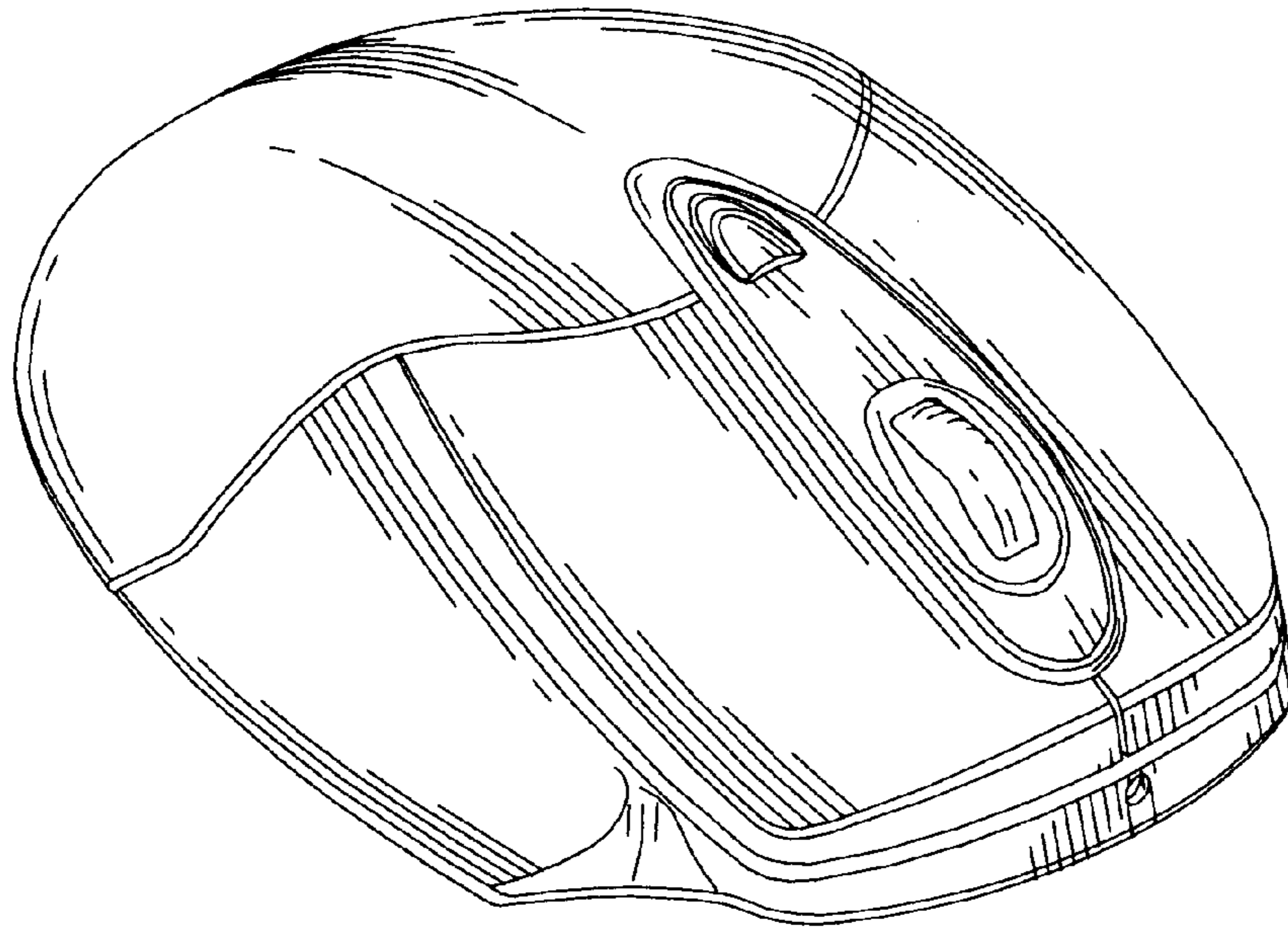

FIG 1

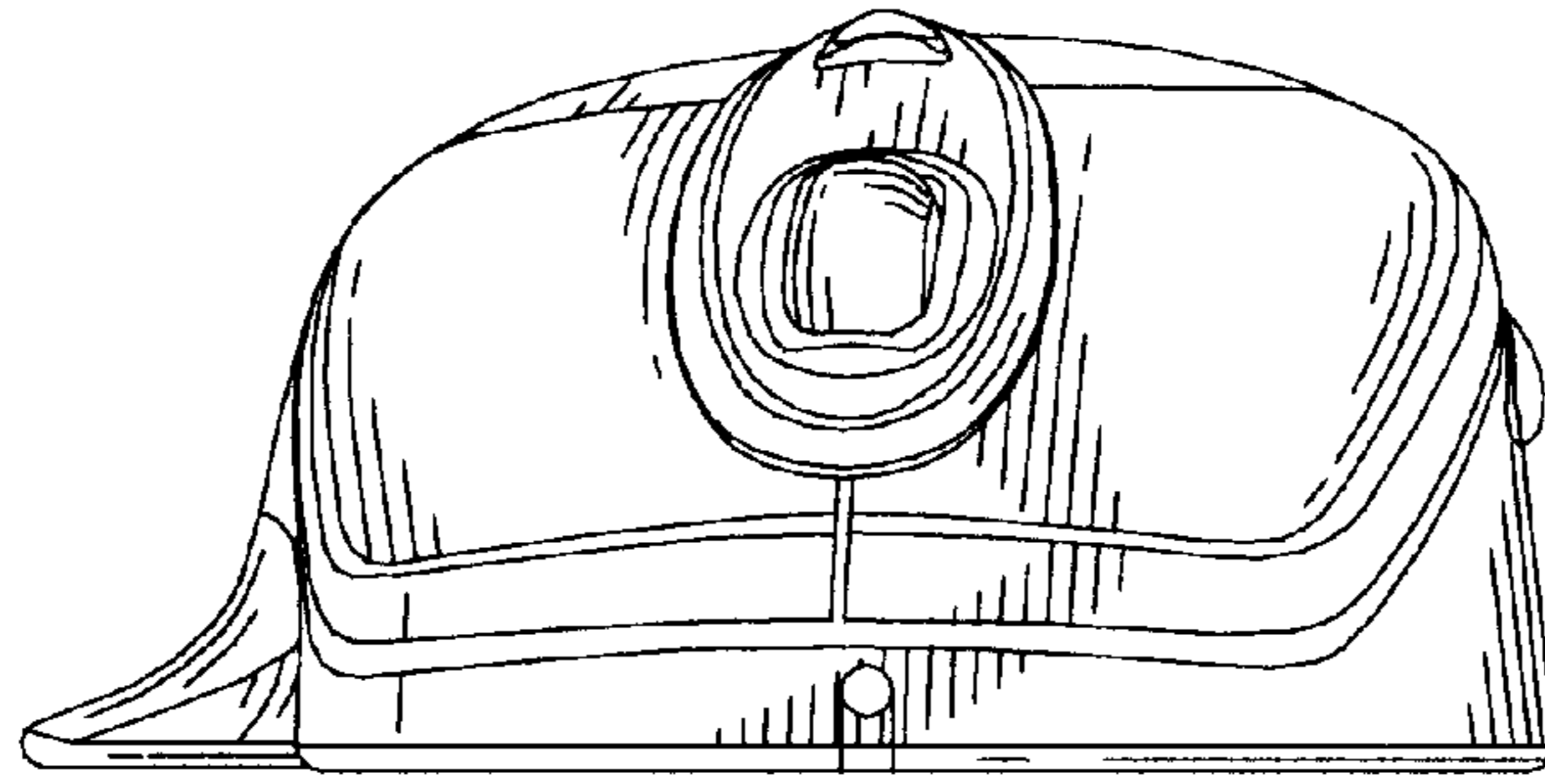

FIG 2

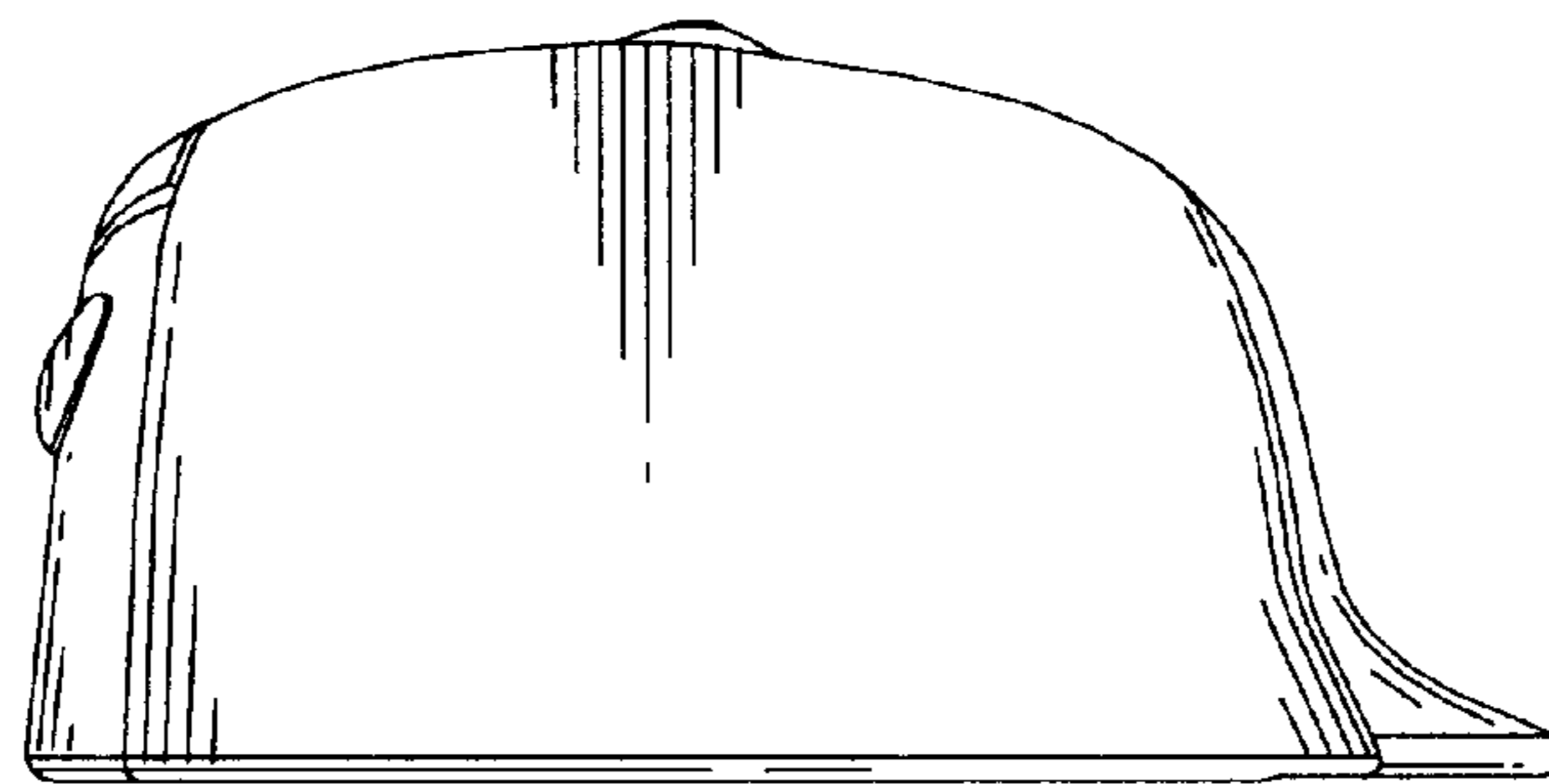

FIG 3

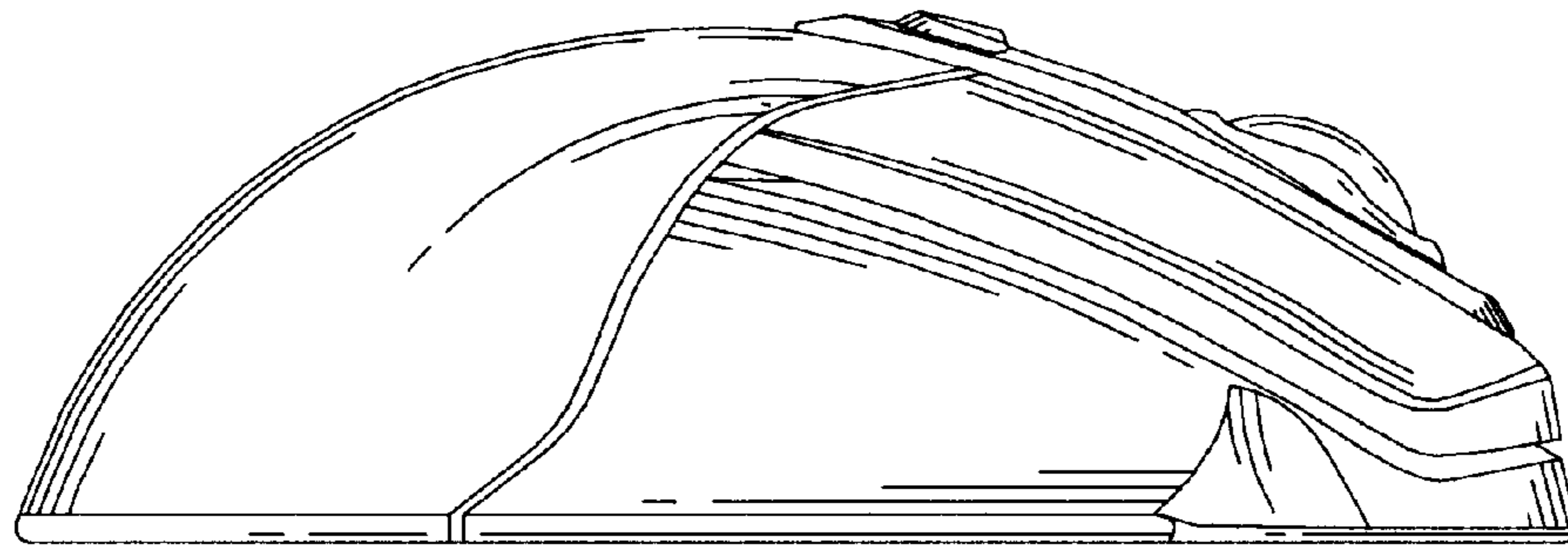

FIG 4

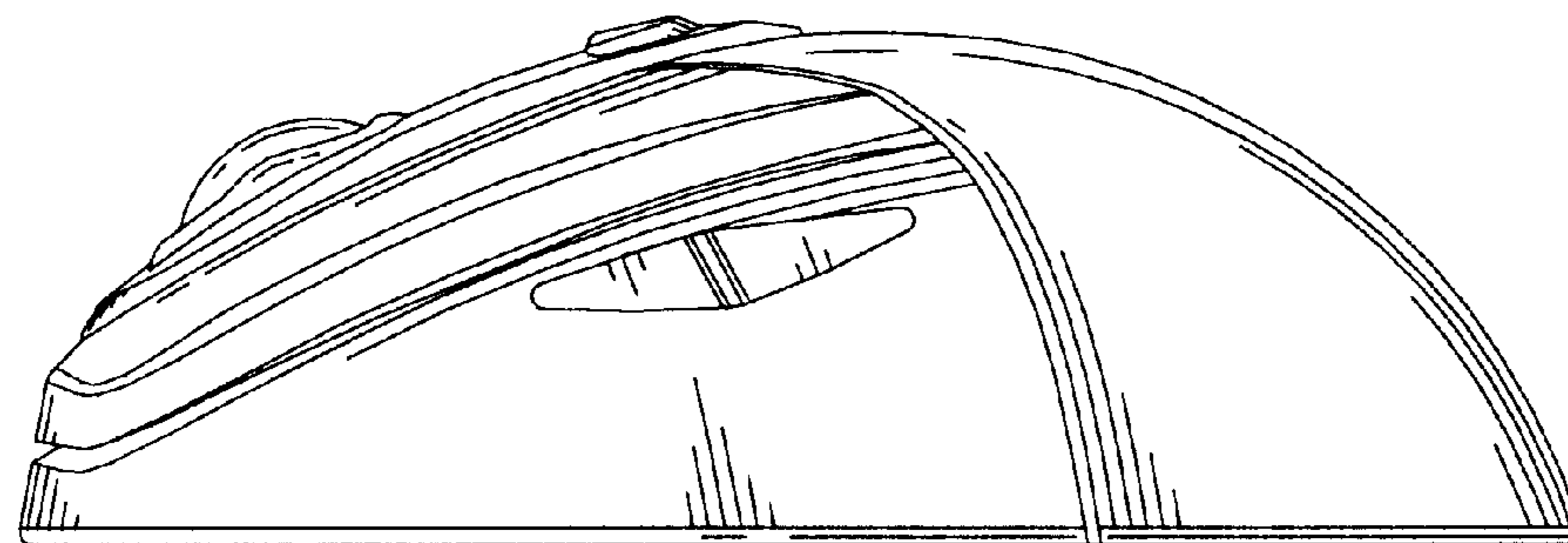

FIG 5

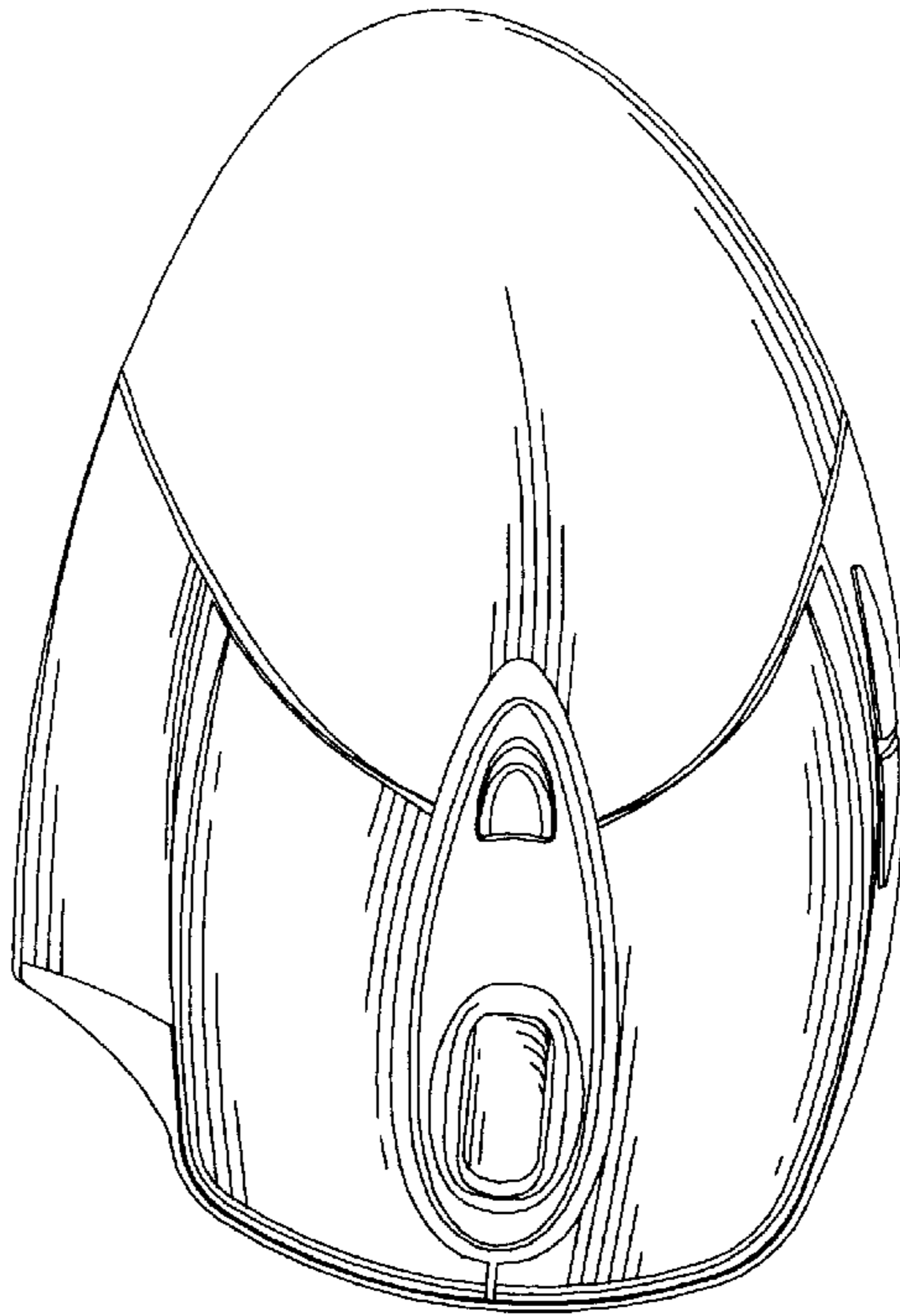

FIG 6

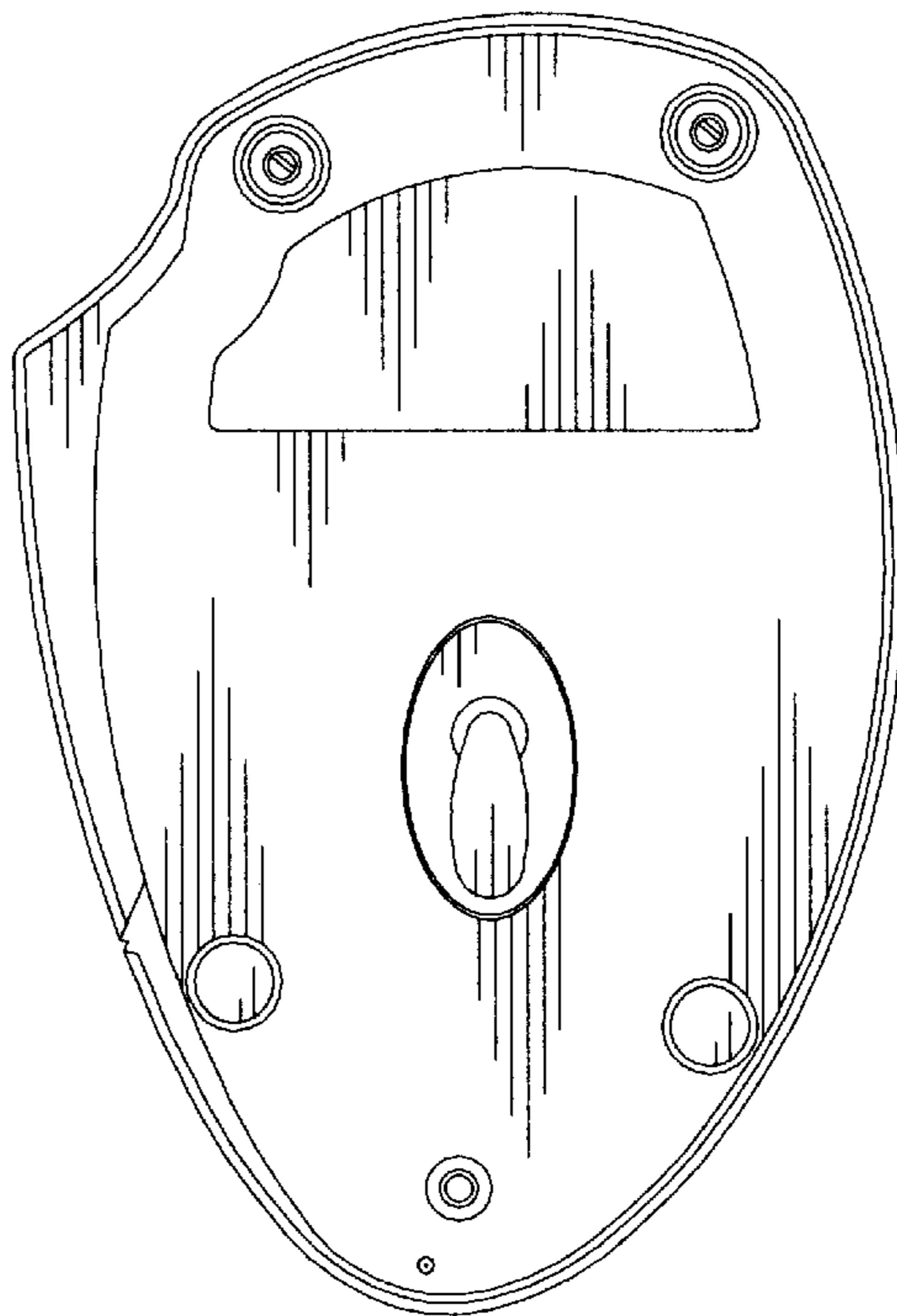

FIG 7