



US00D514419S

(12) **United States Design Patent**
Henriksen

(10) **Patent No.:** **US D514,419 S**

(45) **Date of Patent:** **** Feb. 7, 2006**

(54) **SHEET METAL CUTTING TOOL**

(76) **Inventor:** **Reid Henriksen**, Box 952, Tofield,
Alberta (CA), T0B 4J0

(**) **Term:** **14 Years**

(21) **Appl. No.:** **29/205,999**

(22) **Filed:** **May 24, 2004**

(30) **Foreign Application Priority Data**

Nov. 24, 2003 (CA) 105014

(51) **LOC (8) Cl.** **08-03**

(52) **U.S. Cl.** **D8/98**

(58) **Field of Classification Search** D8/98,
D8/99, 100, 101, 107, 14, 45, 88, 89; 30/151,
30/165, 340, 343, 329, 337, 294
See application file for complete search history.

(56) **References Cited**

U.S. PATENT DOCUMENTS

- 2,948,960 A * 8/1960 Eckstein 30/162
- 3,965,575 A * 6/1976 Stunger 30/294
- 4,713,884 A * 12/1987 Dunnagan 30/294
- D299,807 S * 2/1989 Sawa D7/649
- D300,600 S * 4/1989 High D8/98
- 4,821,418 A * 4/1989 Windhager 30/329

- D333,418 S * 2/1993 Thompson et al. D8/99
- D379,293 S * 5/1997 Schultz D8/98
- D442,665 S * 5/2001 Caudle et al. D22/107

* cited by examiner

Primary Examiner—Philip S. Hyder

(74) *Attorney, Agent, or Firm*—Christensen O'Connor
Johnson Kindness PLLC

(57) **CLAIM**

The ornamental design for a sheet metal cutting tool, as shown and described.

DESCRIPTION

FIG. 1 is a perspective view of a sheet metal cutting tool. FIG. 2 is a right side elevation view of the sheet metal tool illustrated in FIG. 1, the left side elevation view being a mirror image view.

FIG. 3 is a top plan view of the sheet metal tool illustrated in FIG. 1.

FIG. 4 is a bottom plan view of the sheet metal tool illustrated in FIG. 1.

FIG. 5 is an end elevation view of a handle end of the sheet metal tool illustrated in FIG. 1; and,

FIG. 6 is an end elevation view of a piercing tip end of the sheet metal tool illustrated in FIG. 1.

1 Claim, 3 Drawing Sheets

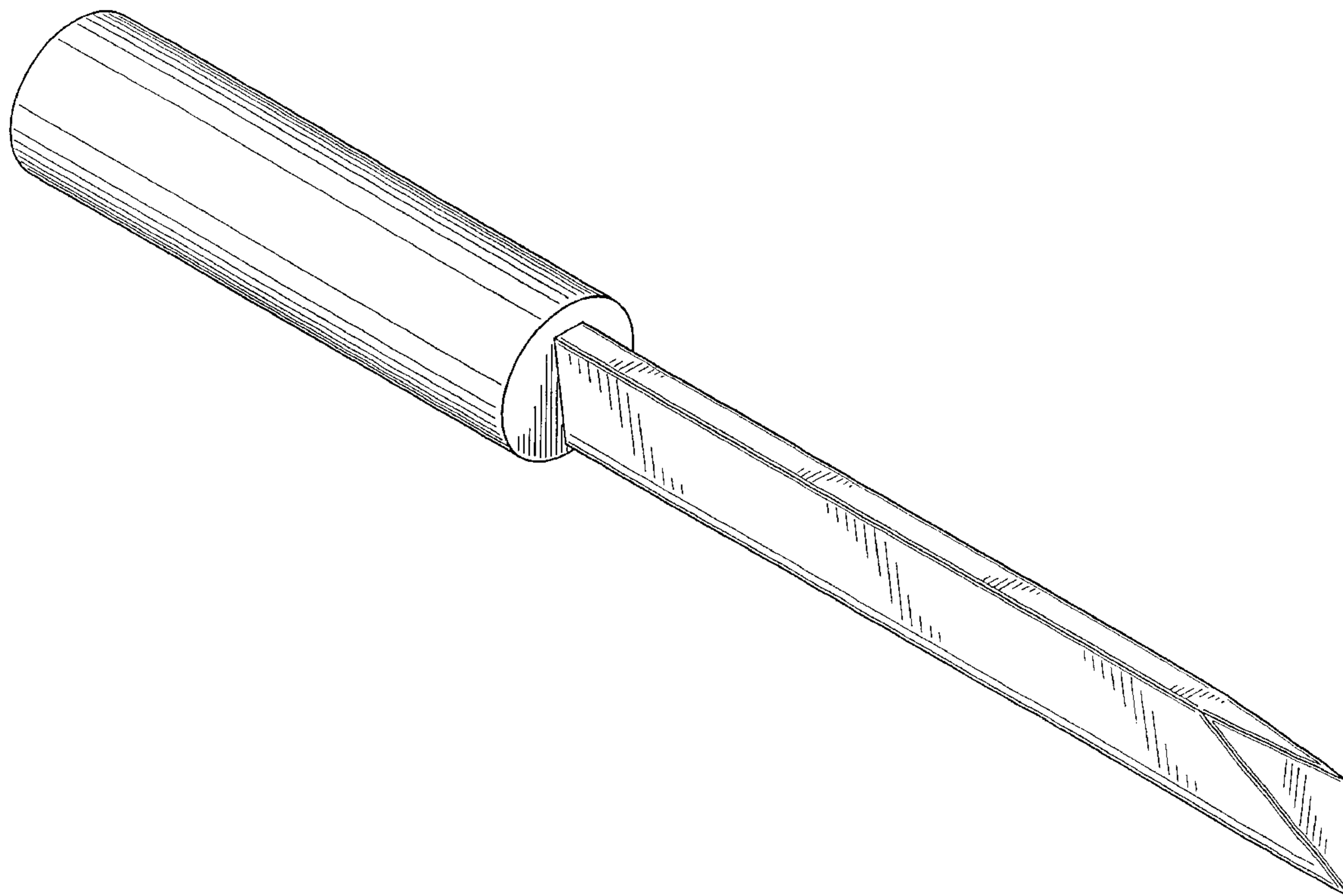

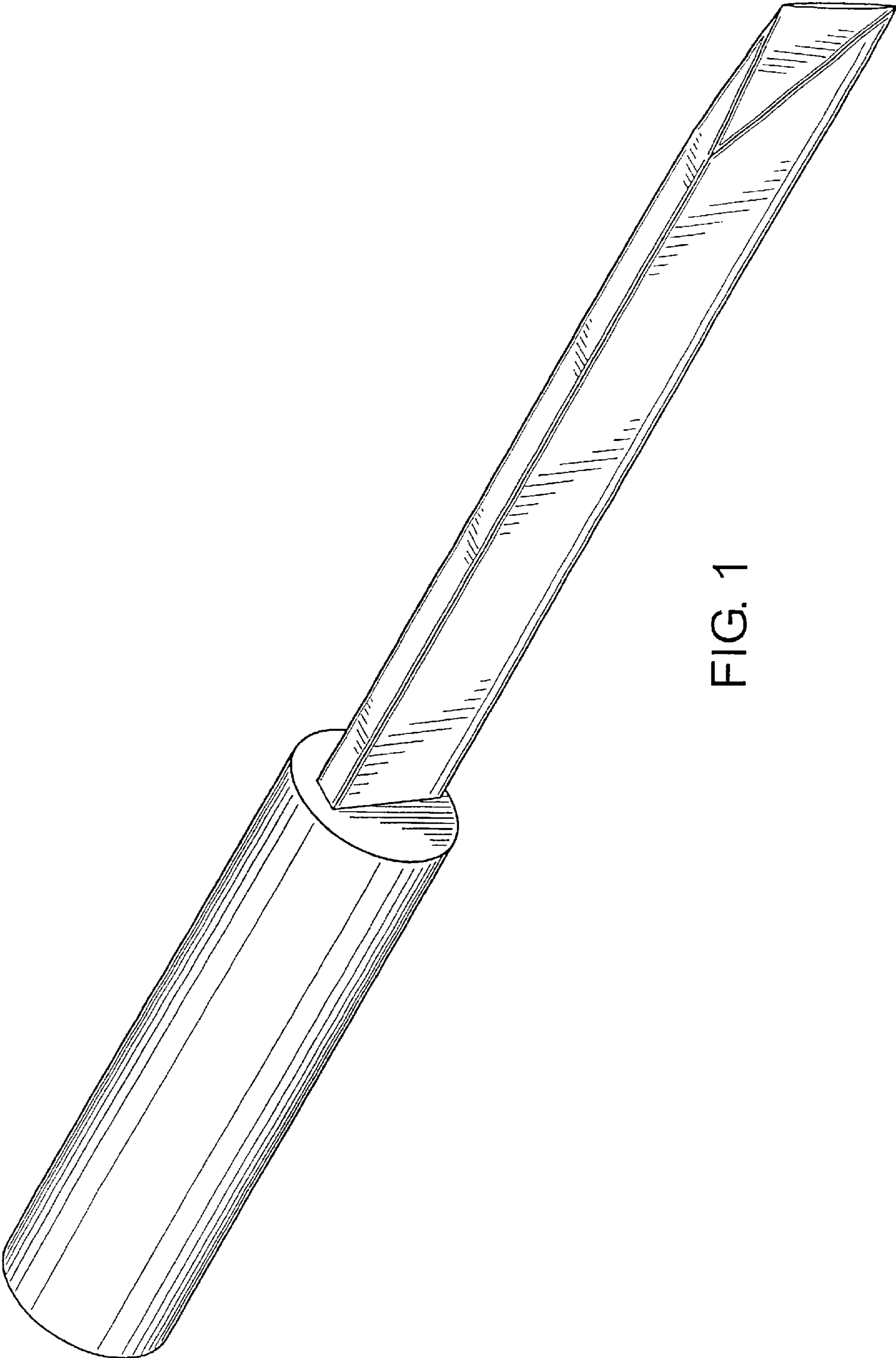

FIG. 1

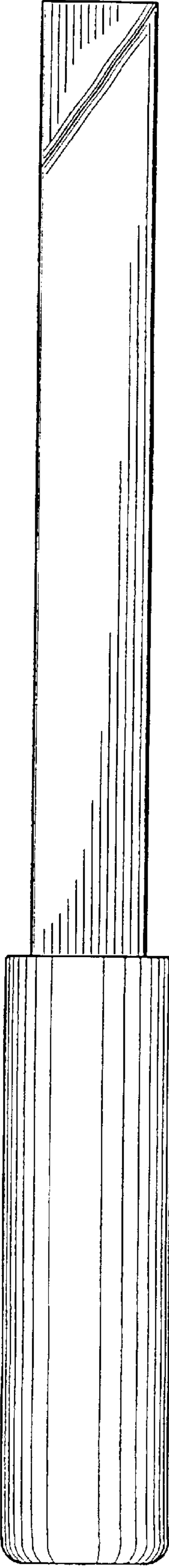

FIG. 2

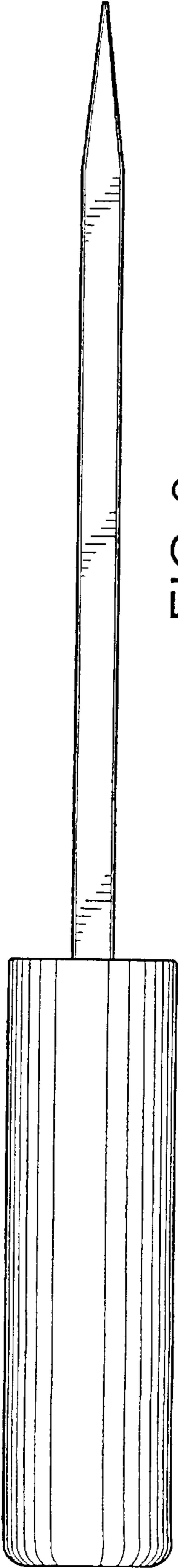

FIG. 3

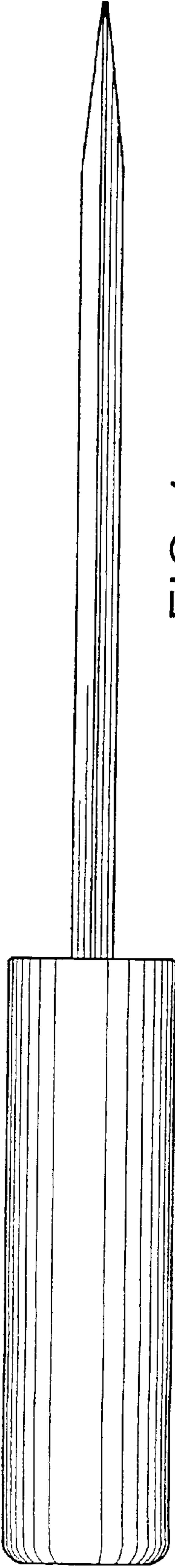

FIG. 4

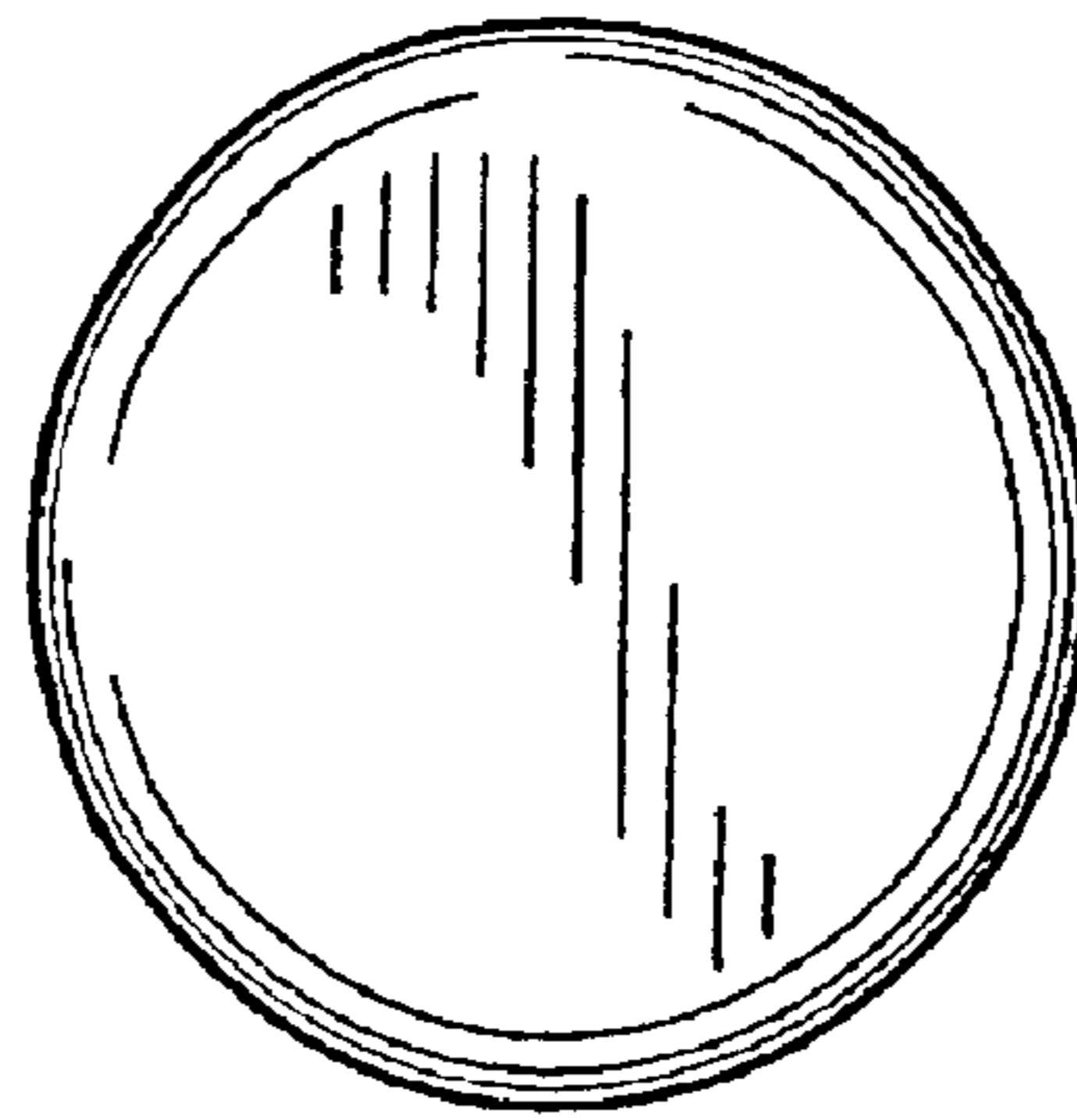

FIG. 5

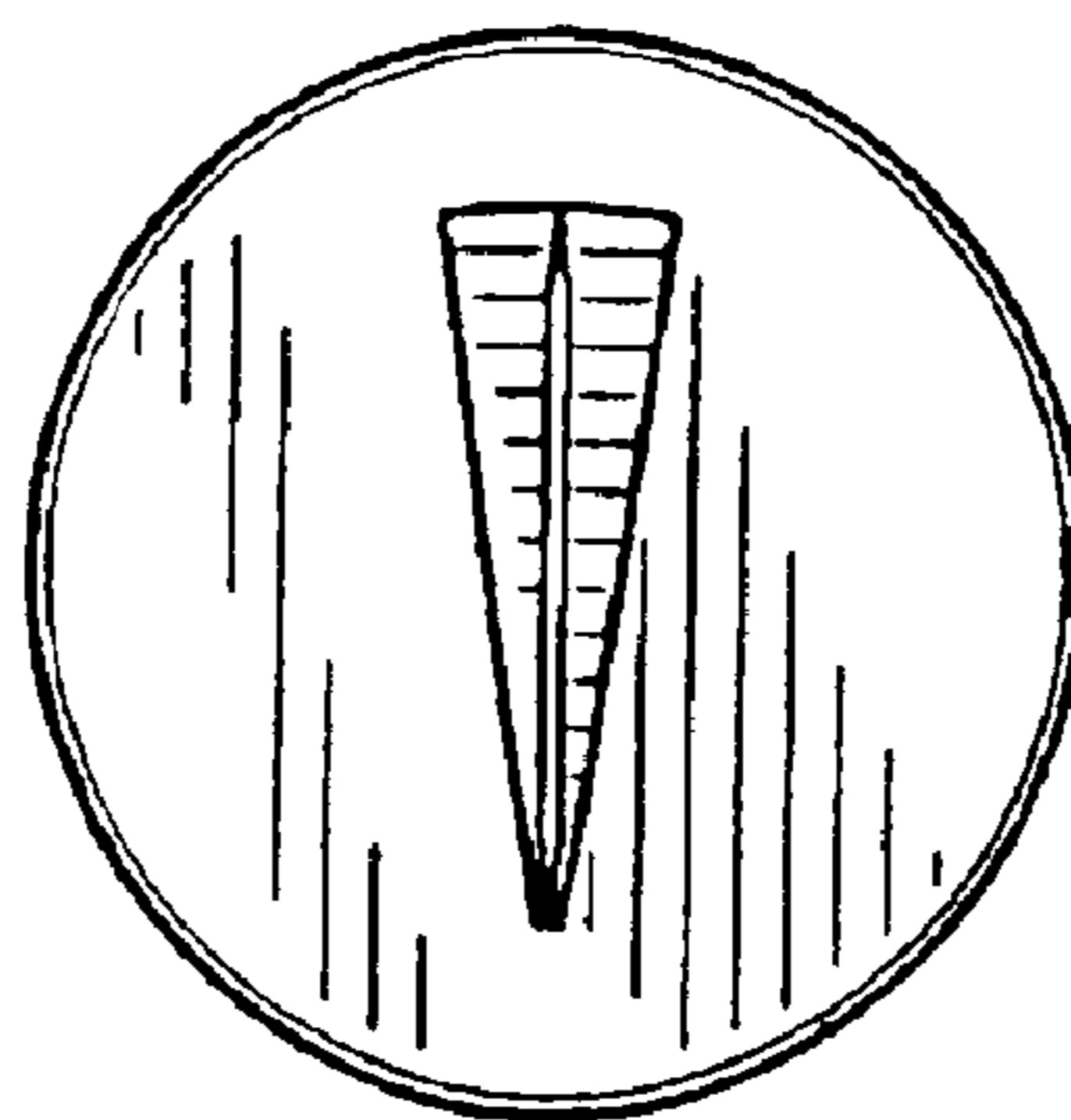

FIG. 6