



US00D514337S

(12) **United States Design Patent**
Harum

(10) **Patent No.:** **US D514,337 S**

(45) **Date of Patent:** **** Feb. 7, 2006**

(54) **CHAIR**

(75) **Inventor:** **Heidi Marie Harum**, Coral Gables, FL
(US)

(73) **Assignee:** **Heidi M. Harum**, Coral Gables, FL
(US)

(**) **Term:** **14 Years**

(21) **Appl. No.:** **29/223,420**

(22) **Filed:** **Feb. 14, 2005**

(51) **LOC (8) Cl.** **06-01**

(52) **U.S. Cl.** **D6/361**

(58) **Field of Classification Search** D6/334,
D6/335, 360, 361, 368, 374, 375, 500-502;
297/445.1, 448.1, 452.17, 440.13
See application file for complete search history.

(56) **References Cited**

U.S. PATENT DOCUMENTS

D141,231 S * 5/1945 Walker, Jr. D6/368
D145,074 S * 6/1946 Gleitsman D6/374

D147,463 S * 9/1947 Luketa D6/360
D149,959 S * 6/1948 Luketa D6/360
D172,378 S * 6/1954 Bell D6/361
D392,117 S * 3/1998 Lee D6/361
D462,845 S * 9/2002 Canto Garcia D6/335

* cited by examiner

Primary Examiner—Mimosa De

(57) **CLAIM**

The ornamental design for a chair, as shown.

DESCRIPTION

FIG. 1 is a perspective view of a chair showing my new design;
FIG. 2 is a slightly enlarged top view thereof;
FIG. 3 is a slightly enlarged front elevational view thereof;
FIG. 4 is a slightly enlarged left side perspective view thereof;
FIG. 5 is a left side perspective view thereof; and,
FIG. 6 is a slightly enlarged left, rear perspective view thereof.
The right side is identical/symmetrical.

1 Claim, 6 Drawing Sheets

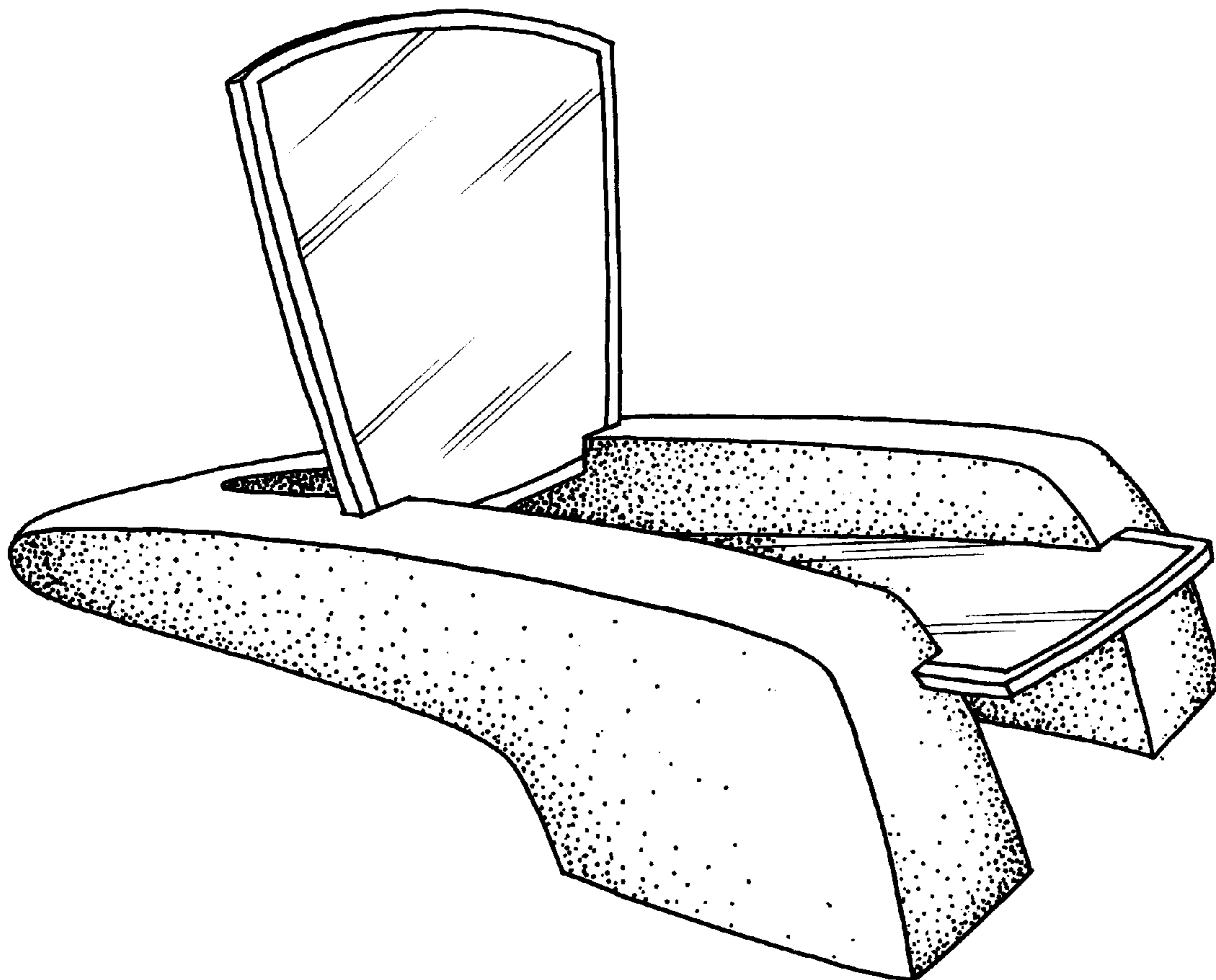

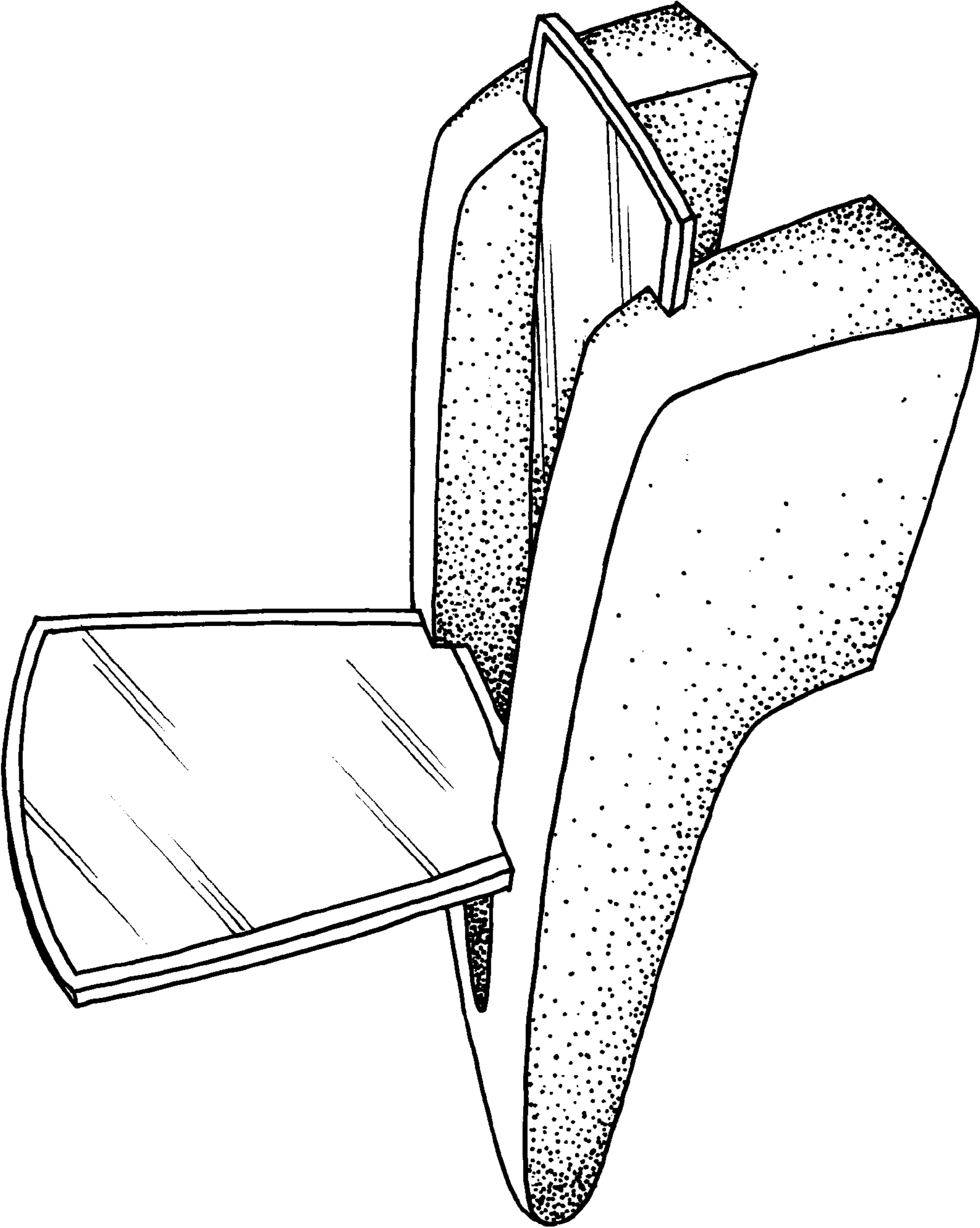

FIG. 1

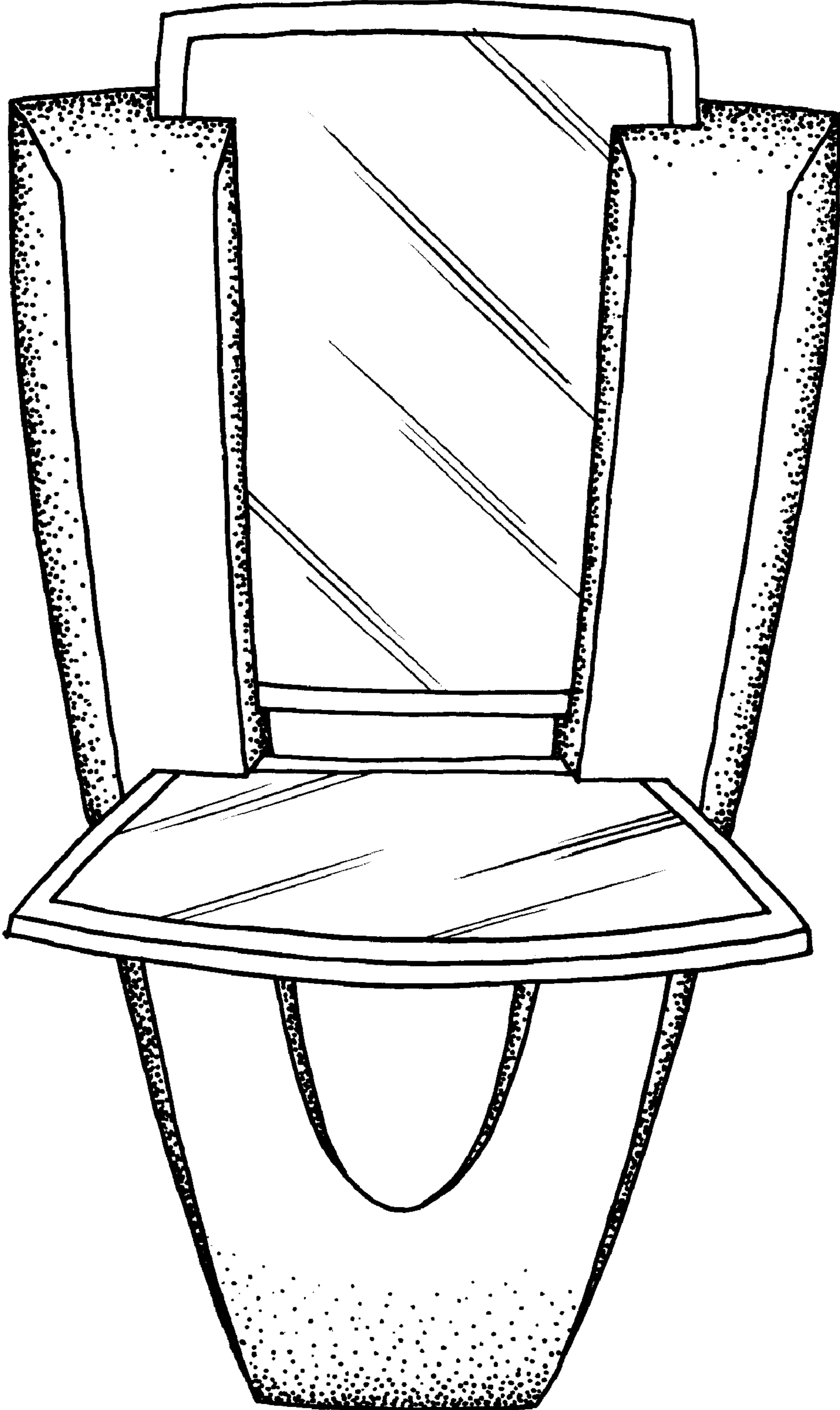

FIG. 2

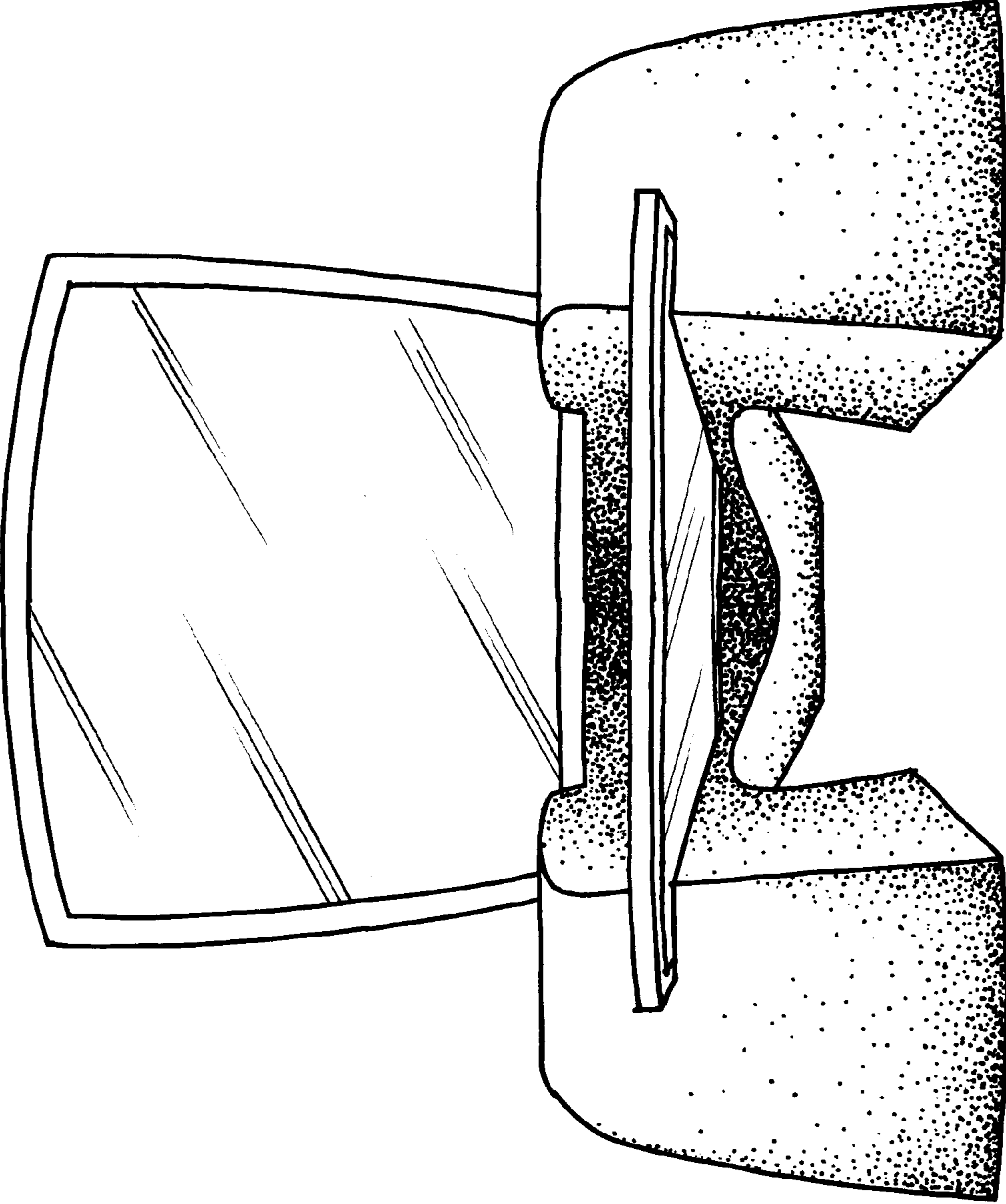

FIG. 3

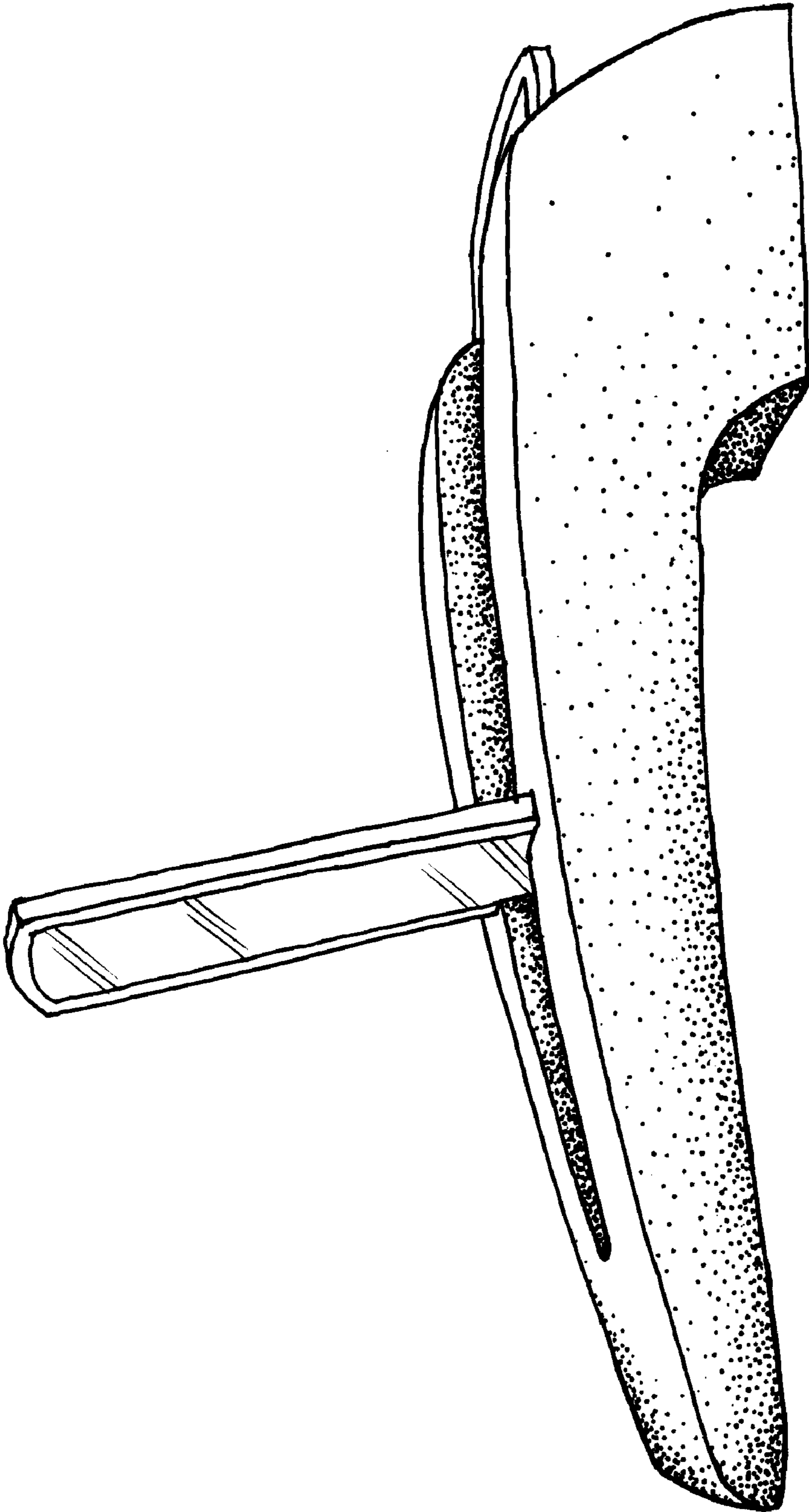

FIG. 4

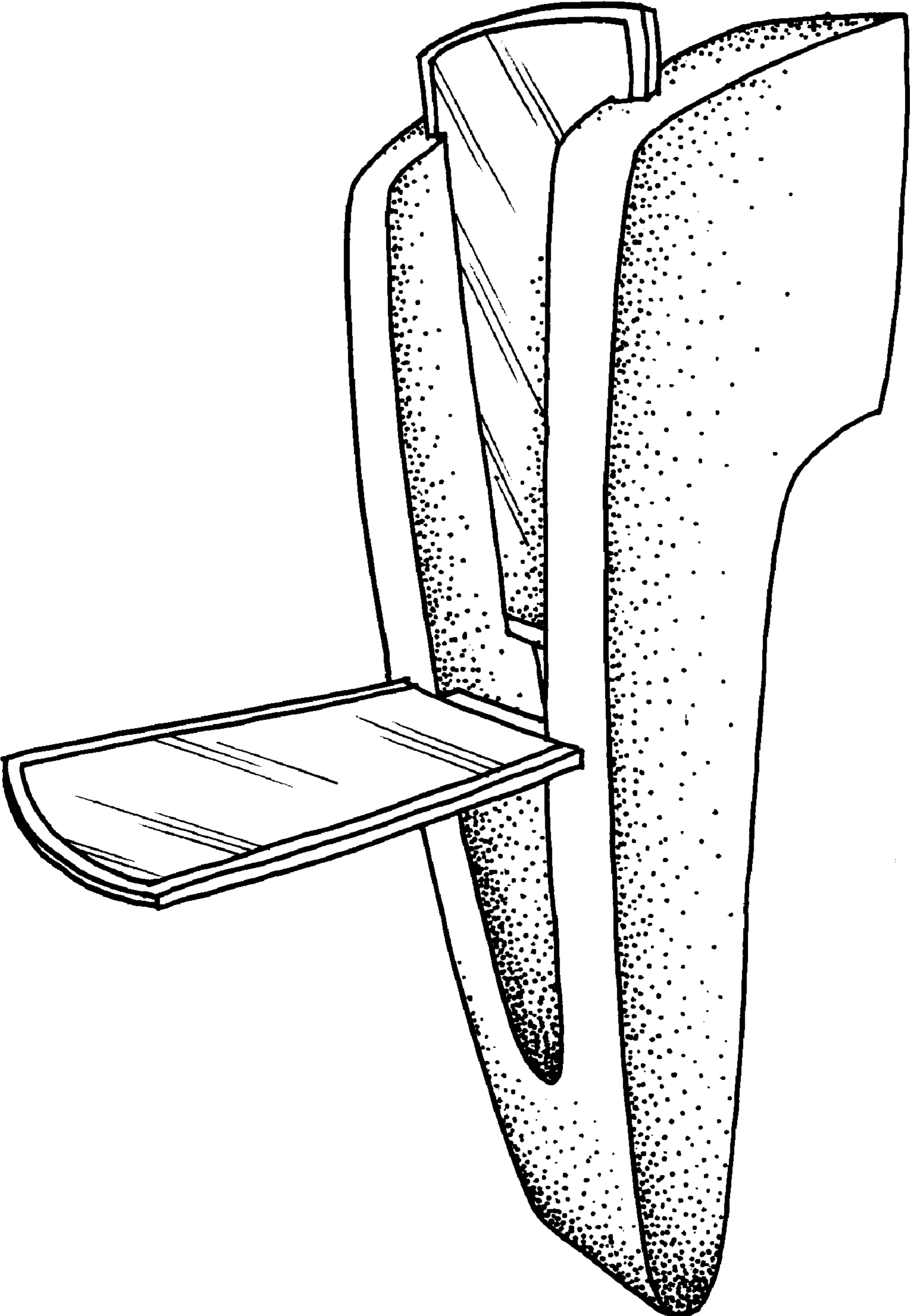

FIG. 5

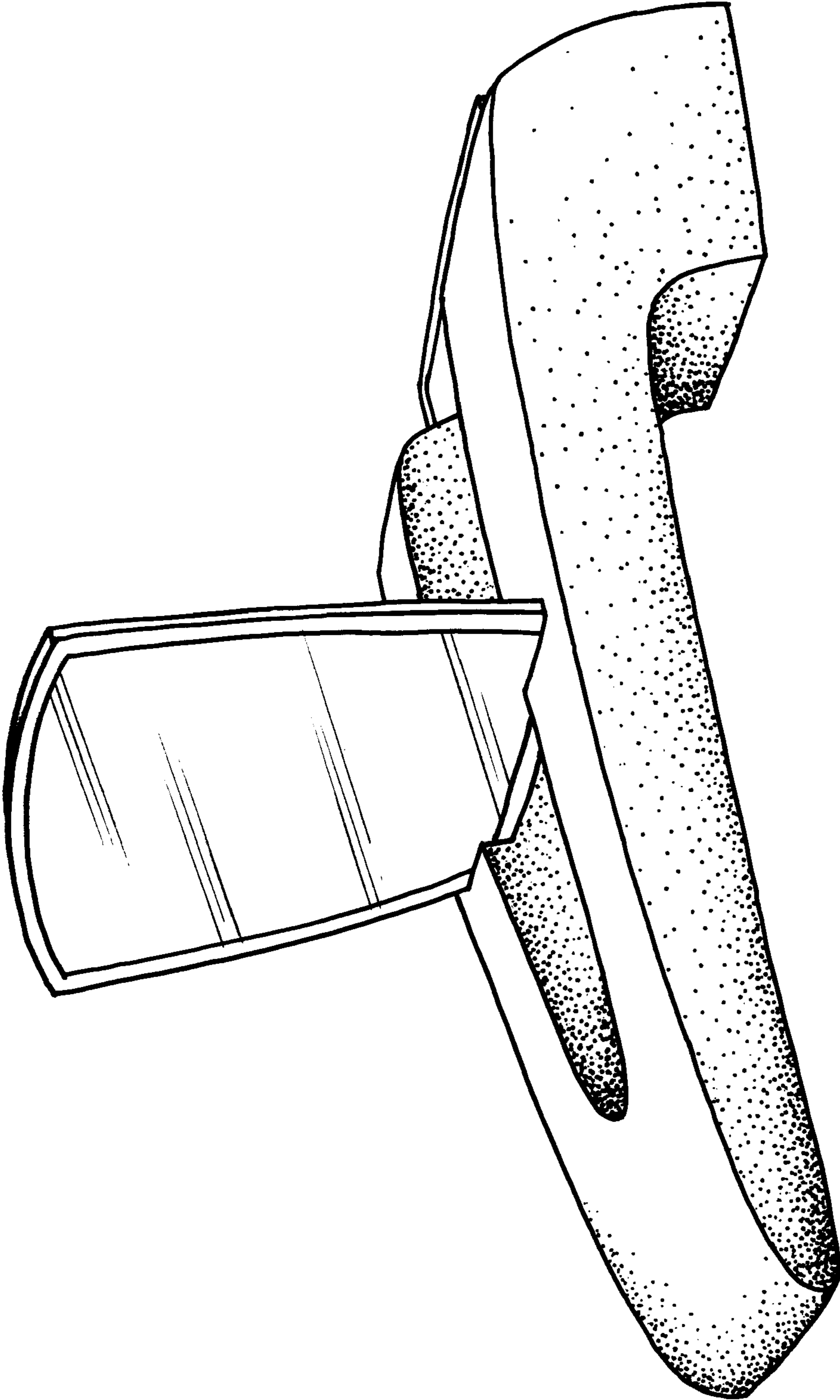

FIG. 6