



US00D514317S

(12) **United States Design Patent**
Conforti

(10) **Patent No.:** **US D514,317 S**
(45) **Date of Patent:** **** Feb. 7, 2006**

(54) **TRANSPORT DEVICE**

(76) **Inventor:** **Carl J Conforti**, 30 Riverview St., Fall River, MA (US) 02724

(**) **Term:** **14 Years**

(21) **Appl. No.:** **29/205,779**

(22) **Filed:** **May 20, 2004**

(51) **LOC (8) Cl.** **03-01**

(52) **U.S. Cl.** **D3/285; D3/301**

(58) **Field of Classification Search** **D3/273, D3/276, 284, 285, 286, 287, 288, 289, 301, D3/267; 190/100, 109, 111, 112, 113; 150/117; 383/110**

See application file for complete search history.

(56) **References Cited**

U.S. PATENT DOCUMENTS

| | | | | | | |
|-----------|---|---|---------|--------------|-------|----------|
| 4,463,789 | A | * | 8/1984 | Leiserson | | 383/97 |
| 4,573,202 | A | * | 2/1986 | Lee | | 383/3 |
| D305,798 | S | * | 1/1990 | Say | | D3/203.6 |
| D340,132 | S | * | 10/1993 | Coyle et al. | | D3/203.8 |
| D412,269 | S | * | 7/1999 | Wyant | | D7/709 |
| D465,086 | S | * | 11/2002 | Watts | | D3/290 |
| D472,379 | S | * | 4/2003 | Hillman | | D3/267 |
| D473,051 | S | * | 4/2003 | Hassett | | D3/267 |
| D476,480 | S | * | 7/2003 | Hillman | | D3/263 |
| D482,525 | S | * | 11/2003 | Fair | | D3/267 |
| D482,842 | S | * | 12/2003 | Fair | | D3/267 |

* cited by examiner

Primary Examiner—Philip S. Hyder

(57) **CLAIM**

The ornamental design for a transport device, as shown and described.

DESCRIPTION

FIG. 1 is a perspective view of the transport device illustrating the new design

FIG. 2 is a front view of the transport device

FIG. 3 is a rear view of the transport device

FIG. 4 is a left side view of the transport device

FIG. 5 is a right side view of the transport device

FIG. 6 is a top plan view of the transport device

FIG. 7 is a bottom plan view of the transport device

FIG. 8 is a perspective view of the transport device illustrating the internal perspective of the side storage pocket

FIG. 9 is a perspective view of the transport device illustrating the internal perspective of the top lid and inner closed insulated component.

FIG. 10 is a perspective exploded assembly view of transport device and the inner insulated component assembly.

FIG. 11 is a perspective view of the inner insulated component.

FIG. 12 is a top view of the inner insulated component.

FIG. 13 is a left side view of the inner insulated component; and,

FIG. 14 is a bottom view of the inner insulated component.

The broken line portions of the structure are for illustrative purposes only and form no part of the claimed design.

1 Claim, 9 Drawing Sheets

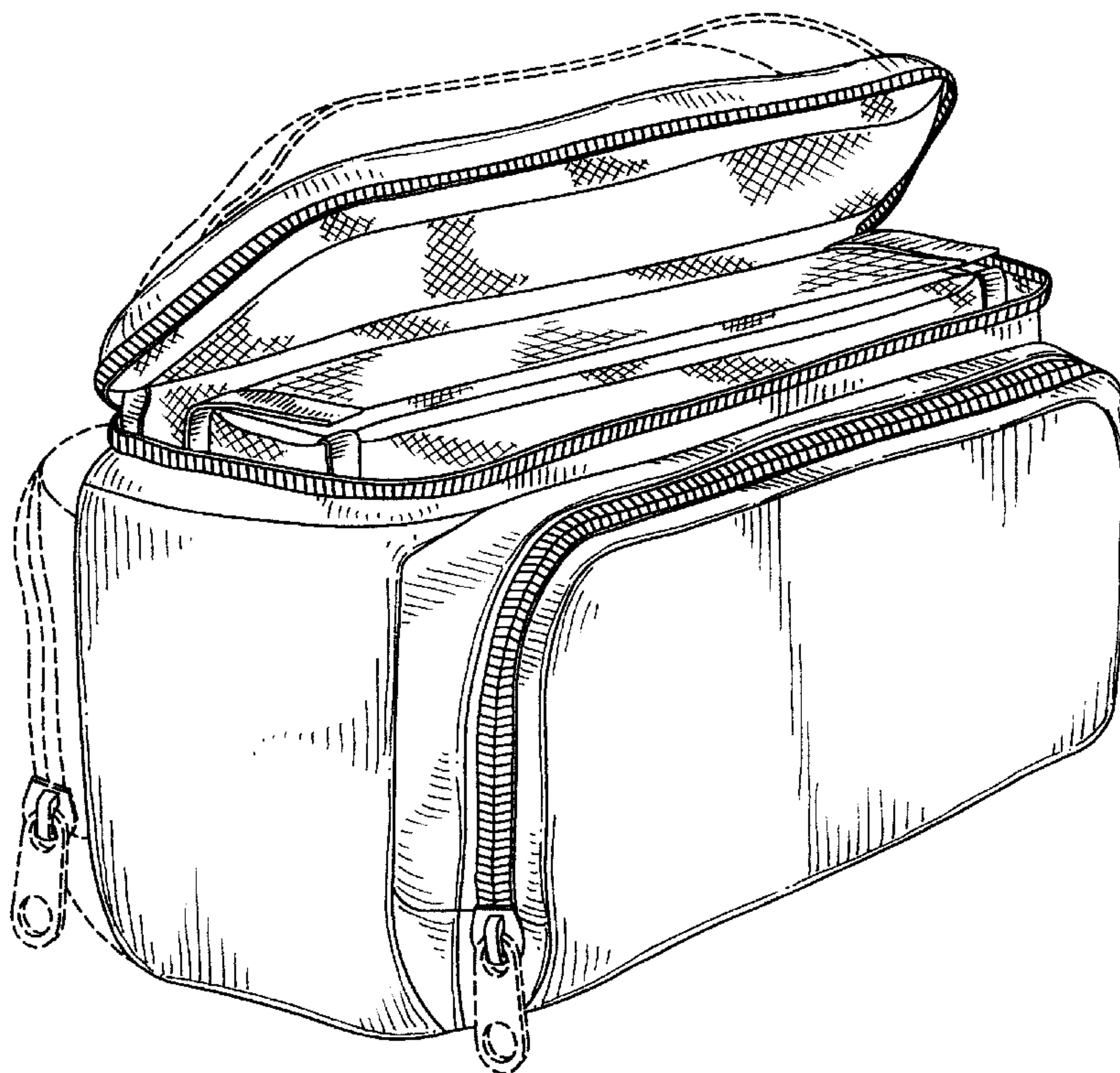

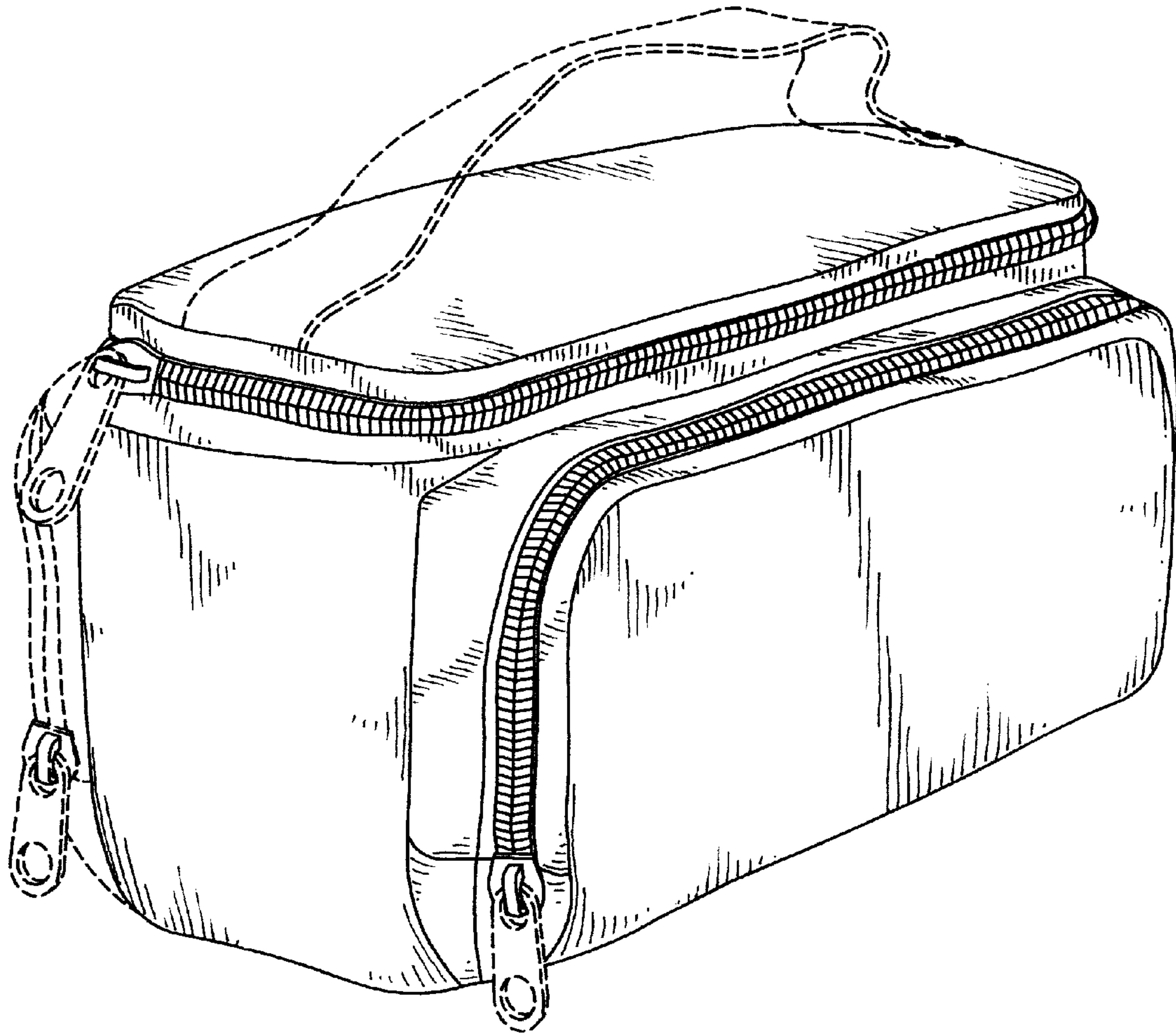

FIG. 1

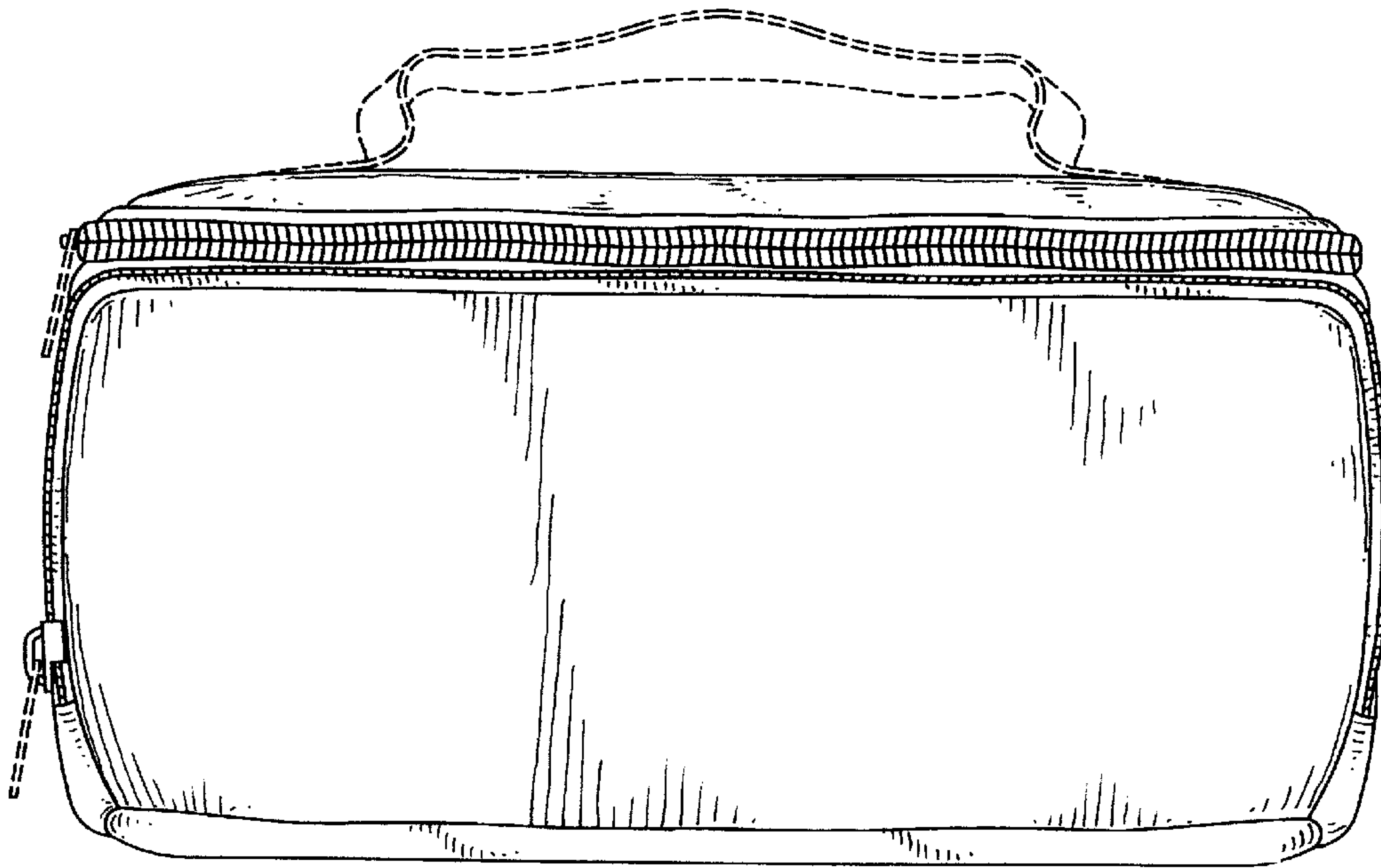

FIG. 2

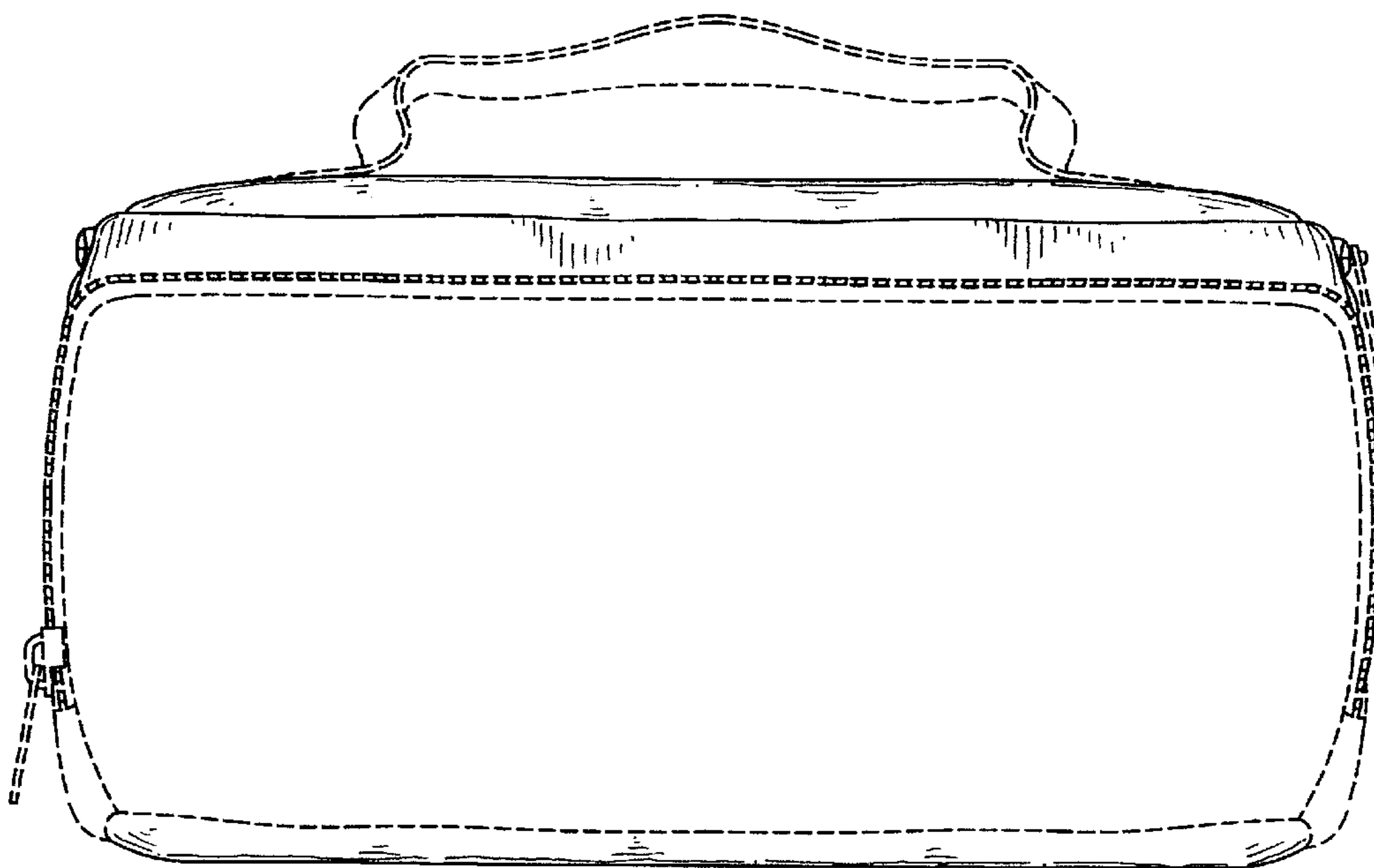

FIG. 3

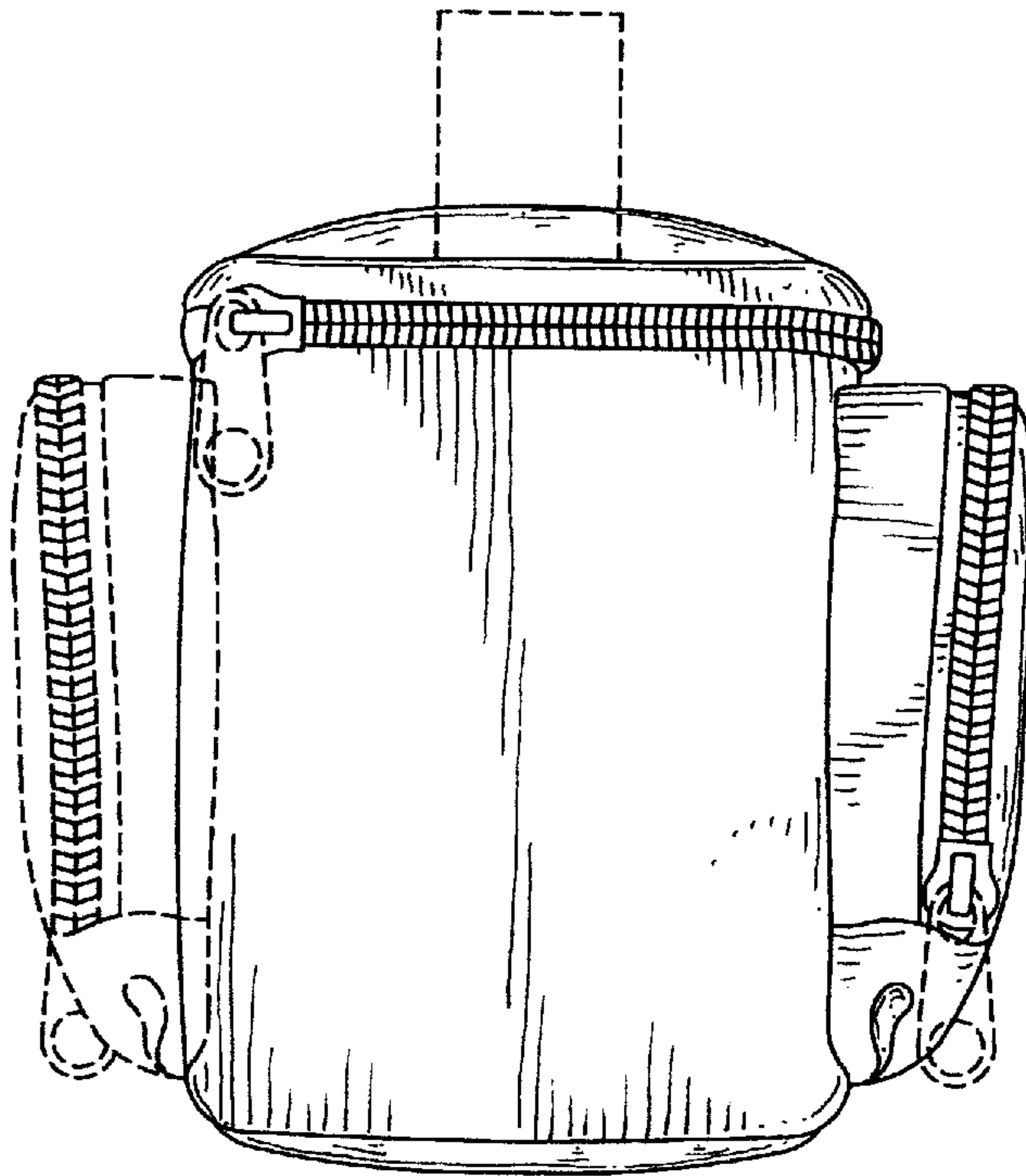

FIG. 4

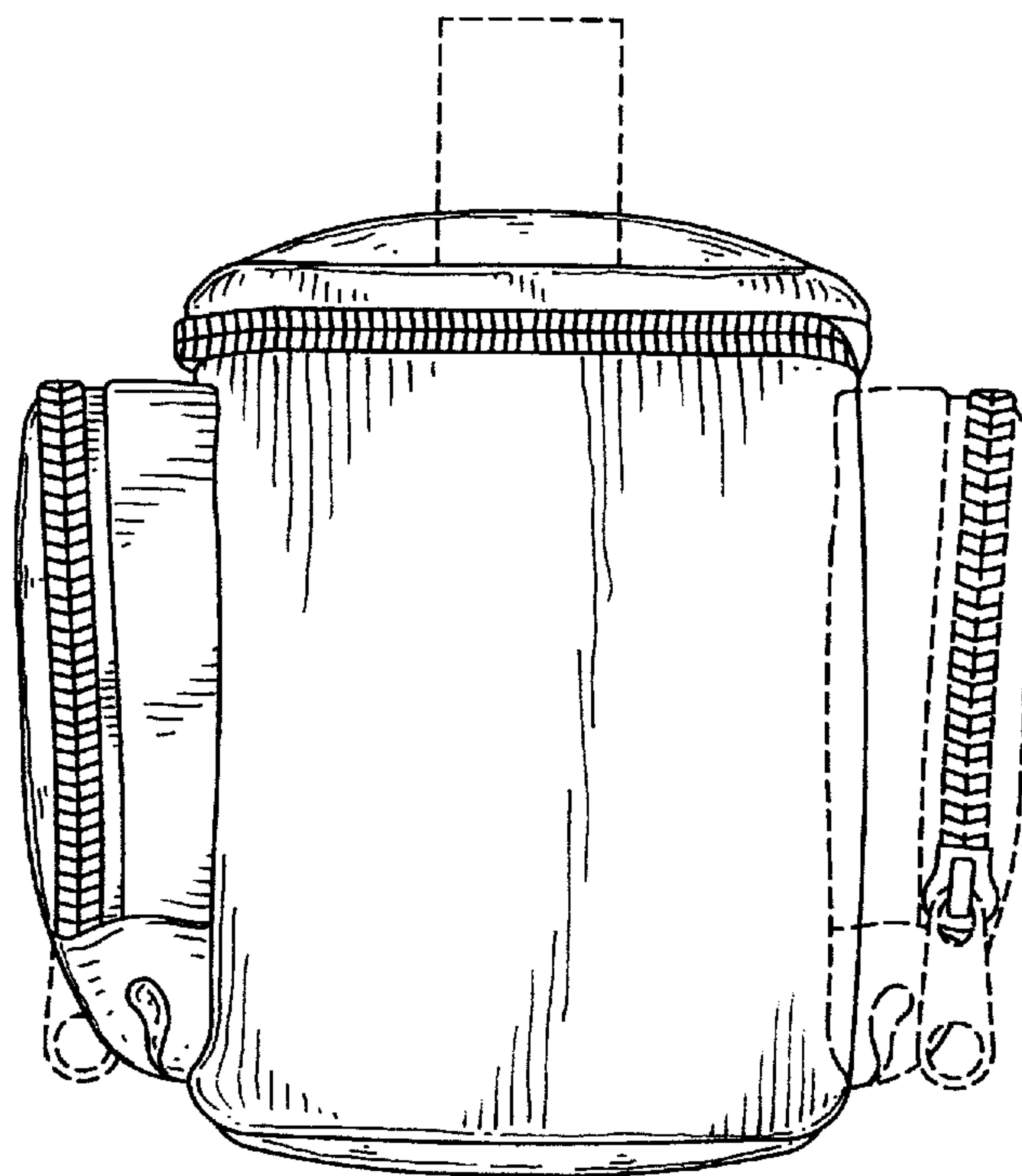

FIG. 5

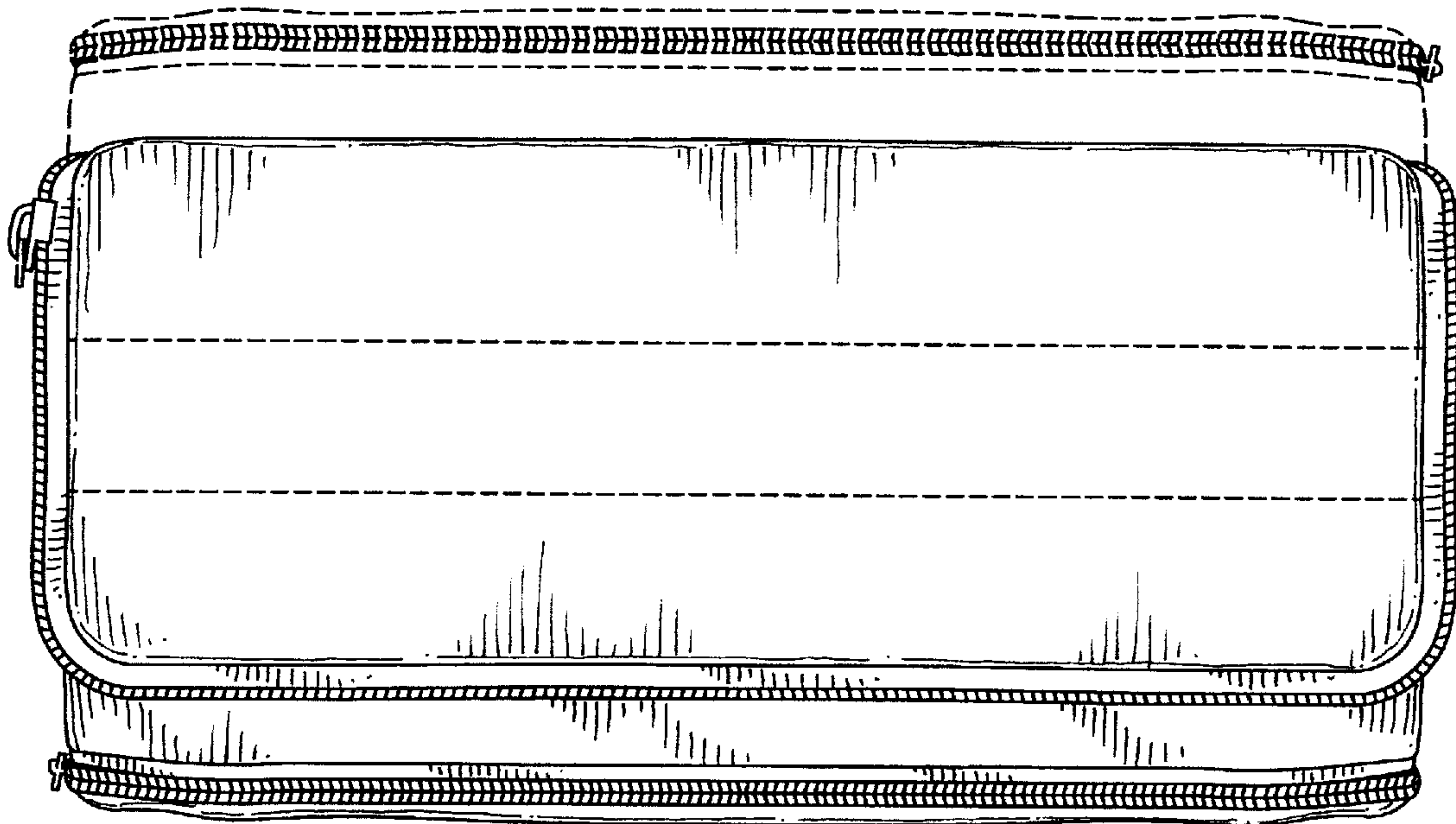

FIG. 6

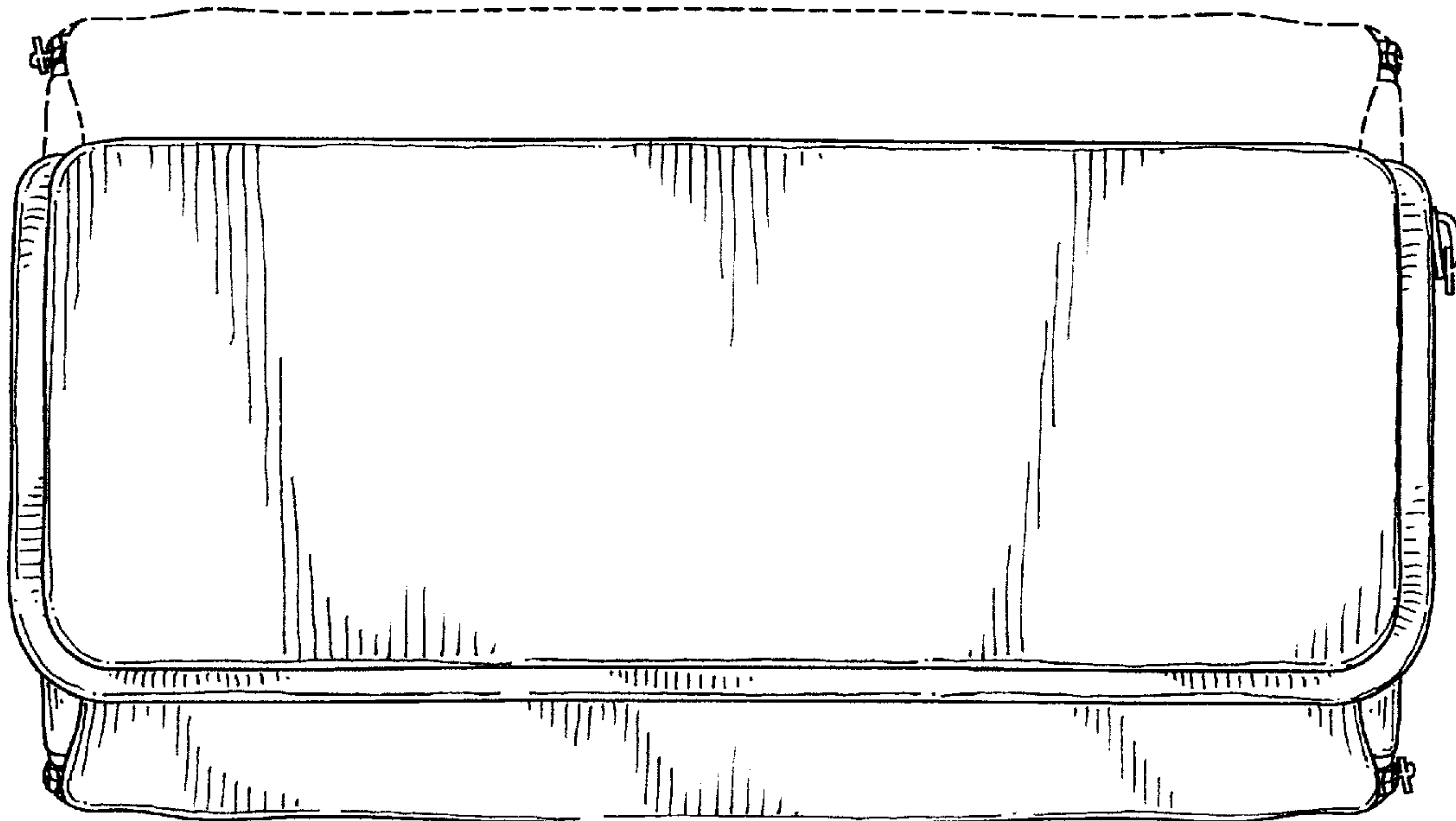

FIG. 7

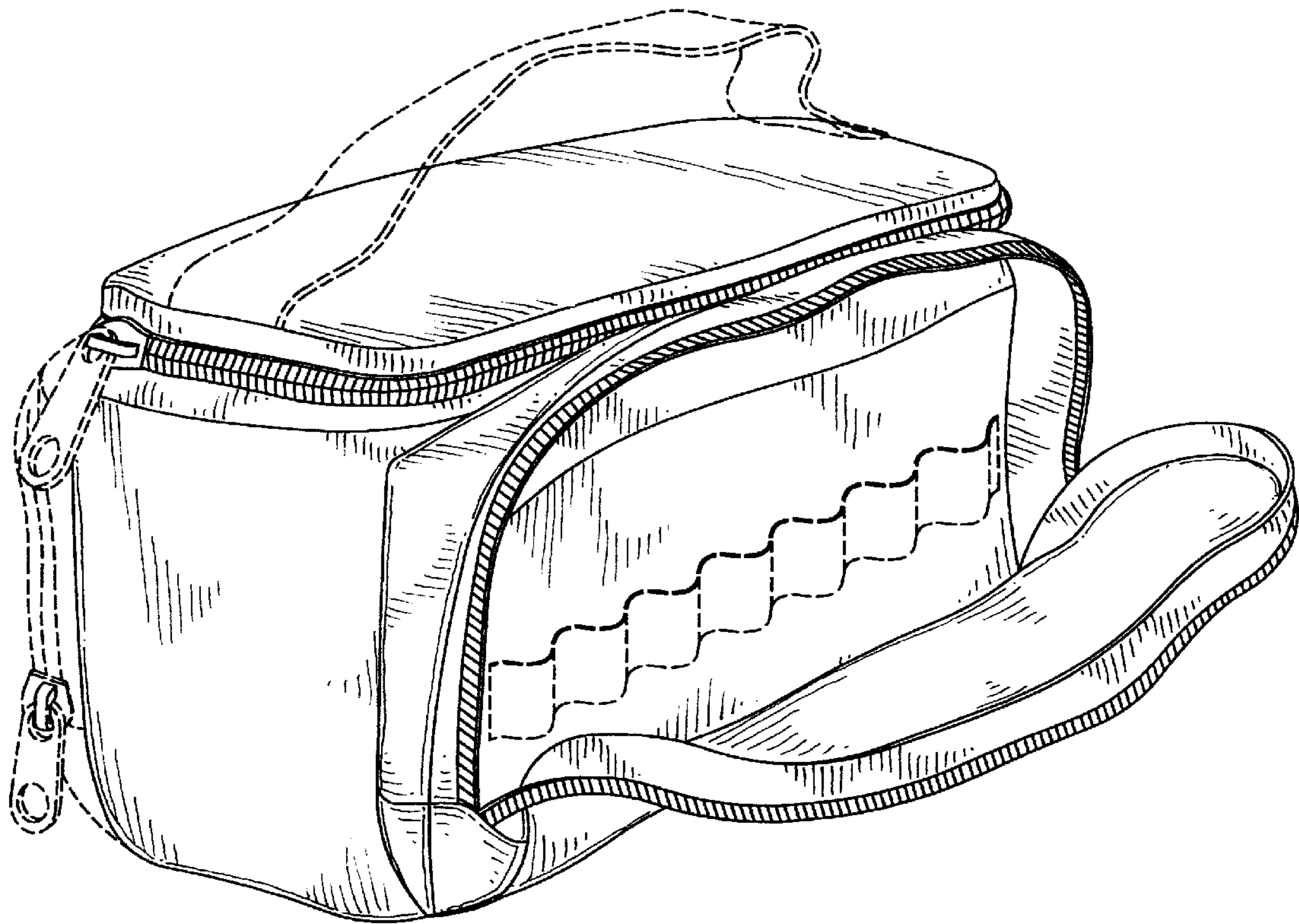

FIG. 8

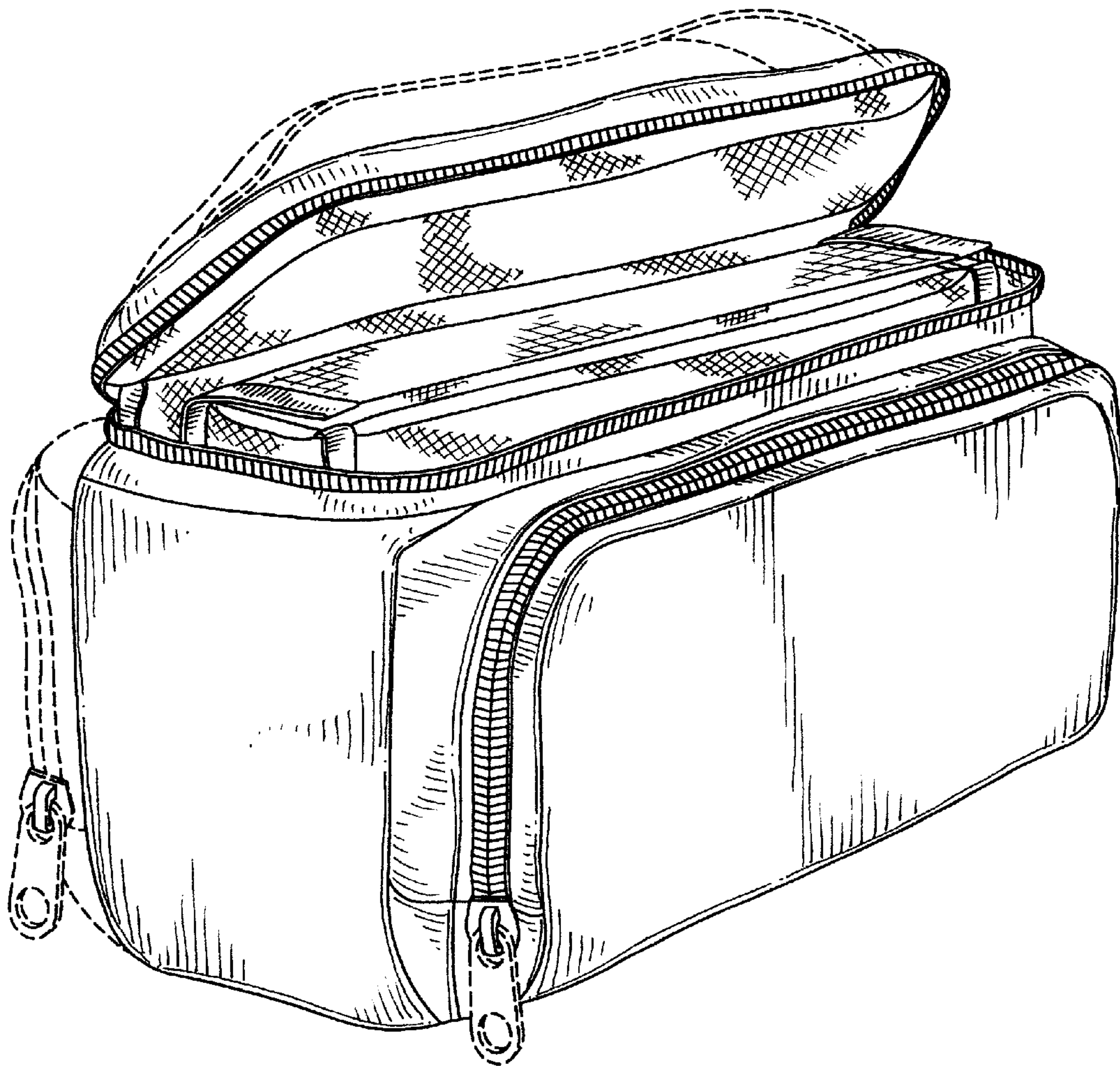

FIG. 9

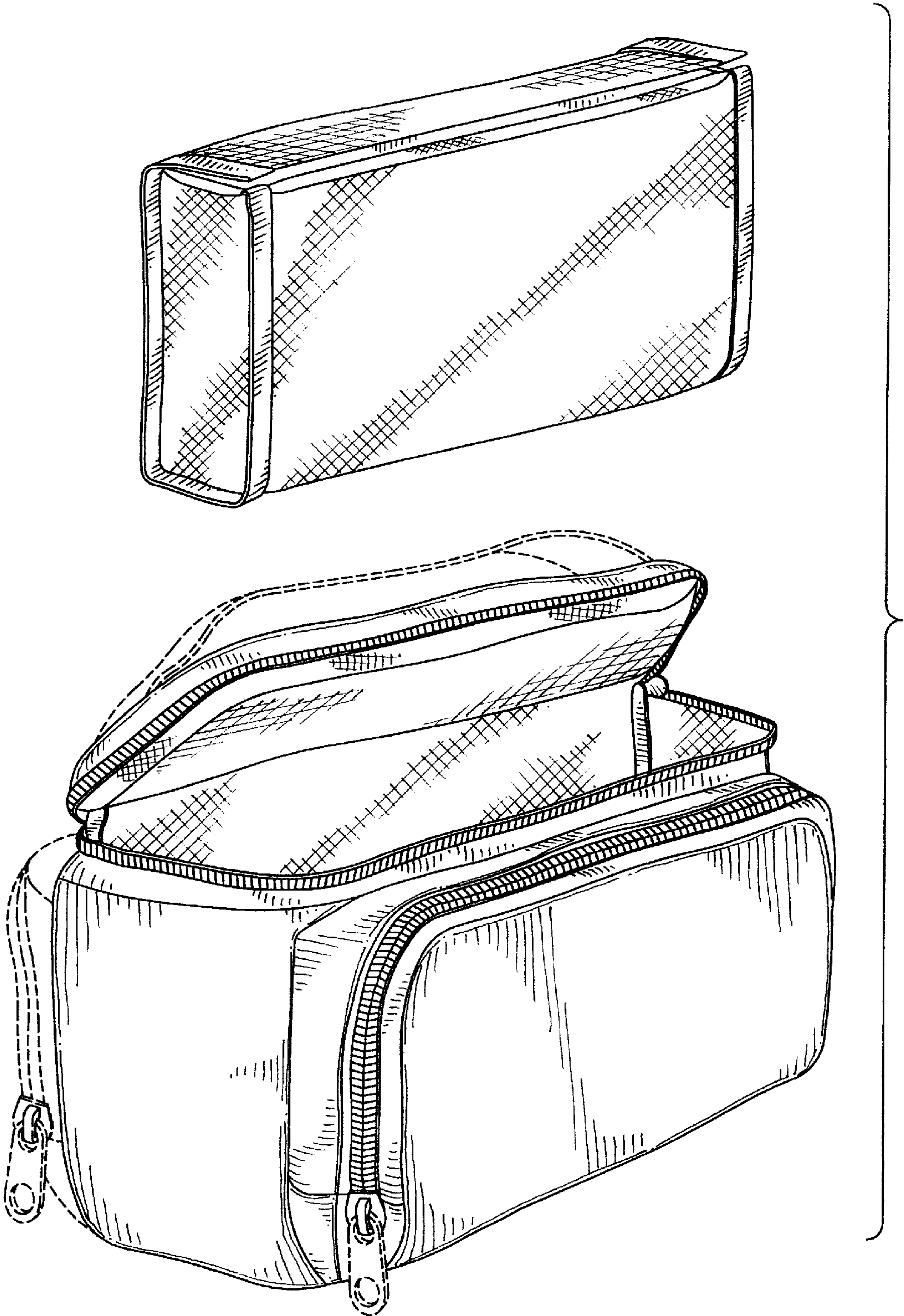

FIG. 10

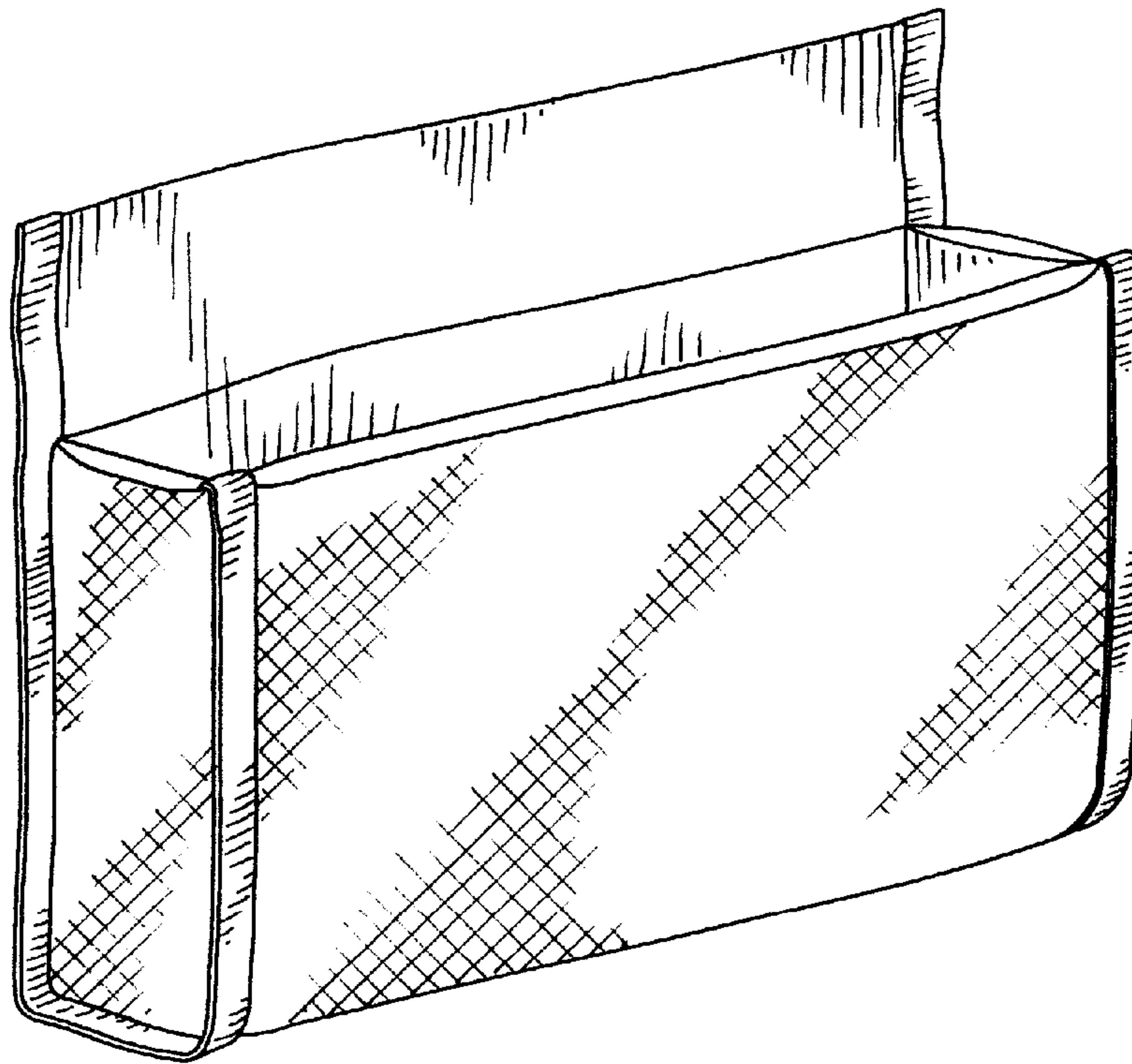

FIG. 11

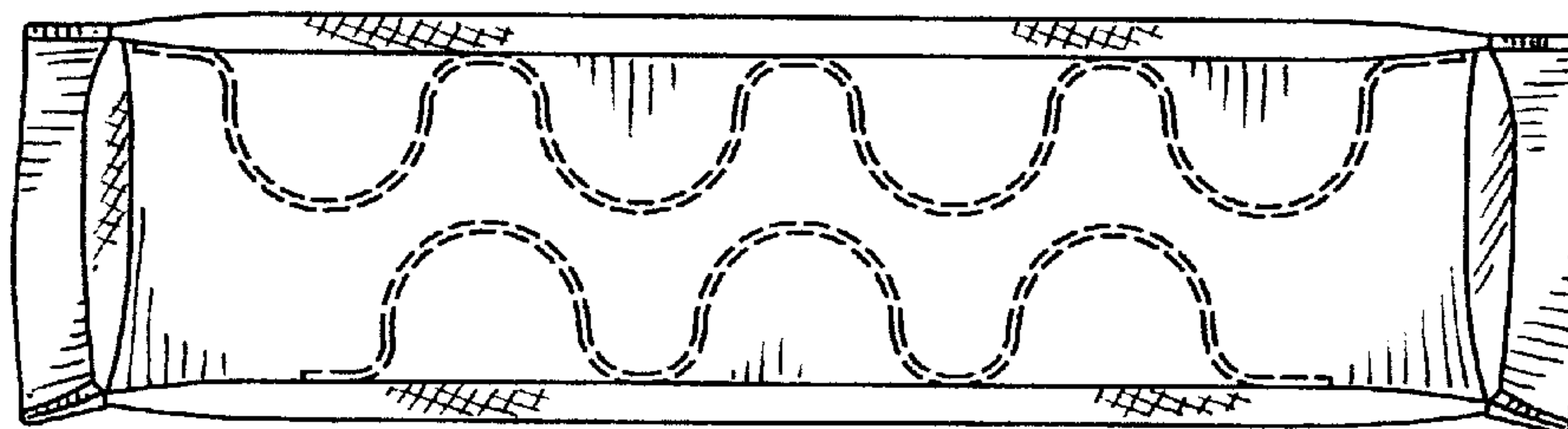

FIG. 12

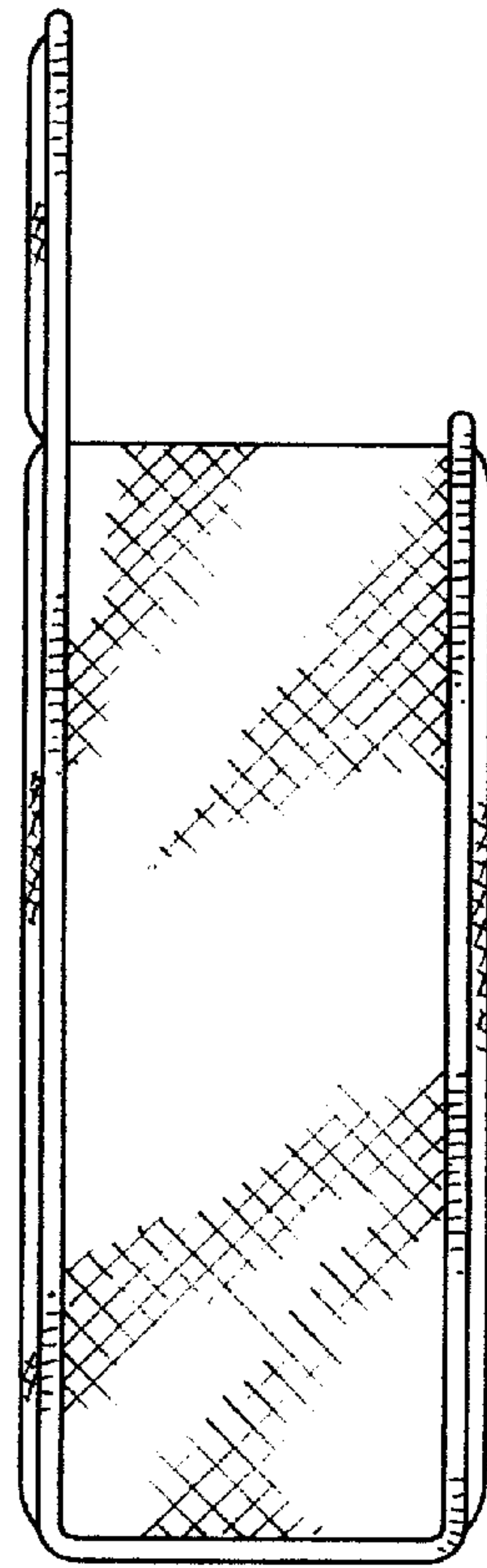

FIG. 13

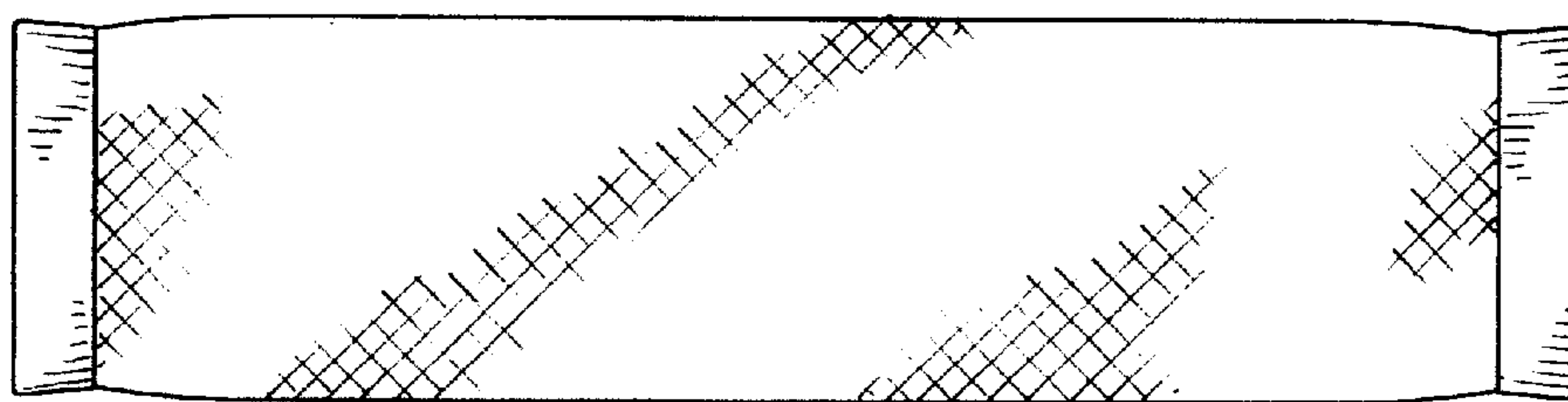

FIG. 14