



US00D514316S

(12) **United States Design Patent**
Allan et al.

(10) **Patent No.: US D514,316 S**

(45) **Date of Patent: ** Feb. 7, 2006**

(54) **TOOL CASE**

D462,520 S * 9/2002 Snider D3/282
D463,911 S * 10/2002 Chen D3/282

(75) Inventors: **Scott W. Allan**, Kitchener (CA);
Satnam Singh, Waterloo (CA);
Antonio Jose Barrios, Waterloo (CA)

FOREIGN PATENT DOCUMENTS

DE 402 01 275.5 2/2002
FR 02 0987 10/2002

(73) Assignee: **Maxtech Manufacturing, Inc.**,
Waterloo (CA)

* cited by examiner

(**) Term: **14 Years**

Primary Examiner—Philip S. Hyder
(74) *Attorney, Agent, or Firm*—R. Craig Armstrong;
Borden Ladner Gervais LLP

(21) Appl. No.: **29/182,532**

(22) Filed: **May 29, 2003**

(57) **CLAIM**

We claim the ornamental design for tool case, as shown.

(51) **LOC (8) Cl. 03-01**

(52) **U.S. Cl. D3/282; D3/905**

(58) **Field of Classification Search** D3/273,
D3/276, 281, 282, 283, 294, 295, 905; 206/349,
206/372, 373, 379; 312/902

DESCRIPTION

See application file for complete search history.

FIG. 1 is a perspective view of the front of the tool case;
FIG. 2 is a perspective view of the rear of the tool case;
FIG. 3 is a left side elevational view of the tool case;
FIG. 4 is a front elevational view of the tool case;
FIG. 5 is a top plan view of the tool case;
FIG. 6 is a right side elevational view of the tool case;
FIG. 7 is a rear elevational view of the tool case;
FIG. 8 is a bottom plan view of the tool case;
FIG. 9 is a perspective view of the top and front of the tool
case in the open position;
FIG. 10 is a perspective view of the bottom and rear of the
tool case in the open position;
FIG. 11 is a top plan view of the tool case in the open
position;
FIG. 12 is a front elevational view of the tool case in the
open position;
FIG. 13 is a right side elevational view of the tool case in the
open position;
FIG. 14 is a left side elevational view of the tool case in the
open position;
FIG. 15 is a bottom plan view of the tool case in the open
position; and,
FIG. 16 is a rear elevational view of the tool case in the open
position.

The design consists of the visual features of the entirety of
the tool case as shown in the drawings.

(56) **References Cited**

U.S. PATENT DOCUMENTS

D188,583 S	8/1960	Moss	
3,426,890 A	2/1969	Bayer	
D222,012 S	9/1971	Harris	
4,344,646 A *	8/1982	Michel	292/87
4,449,629 A	5/1984	Barrieau	
D293,740 S	1/1988	Nadeau	
D305,809 S *	1/1990	Weber et al.	D28/76
D315,057 S	3/1991	Bridges	
5,114,007 A	5/1992	Chen	
D331,662 S	12/1992	Melk	
5,203,469 A	4/1993	Chang et al.	
D351,504 S *	10/1994	Tarozzi	D3/276
D358,257 S *	5/1995	Sidabras et al.	D3/282
D399,652 S *	10/1998	Fang	D3/282
D400,100 S	10/1998	Minard	
D408,143 S *	4/1999	Miller	D3/282
5,893,457 A	4/1999	Wei	
6,070,754 A *	6/2000	Newby, Sr.	220/675
D434,561 S *	12/2000	Vasudeva	D3/282
D440,043 S *	4/2001	Miller et al.	D3/282
6,283,291 B1	9/2001	Vasudeva	
D449,164 S *	10/2001	Rosen	D3/282
D459,885 S	7/2002	Hart	

1 Claim, 6 Drawing Sheets

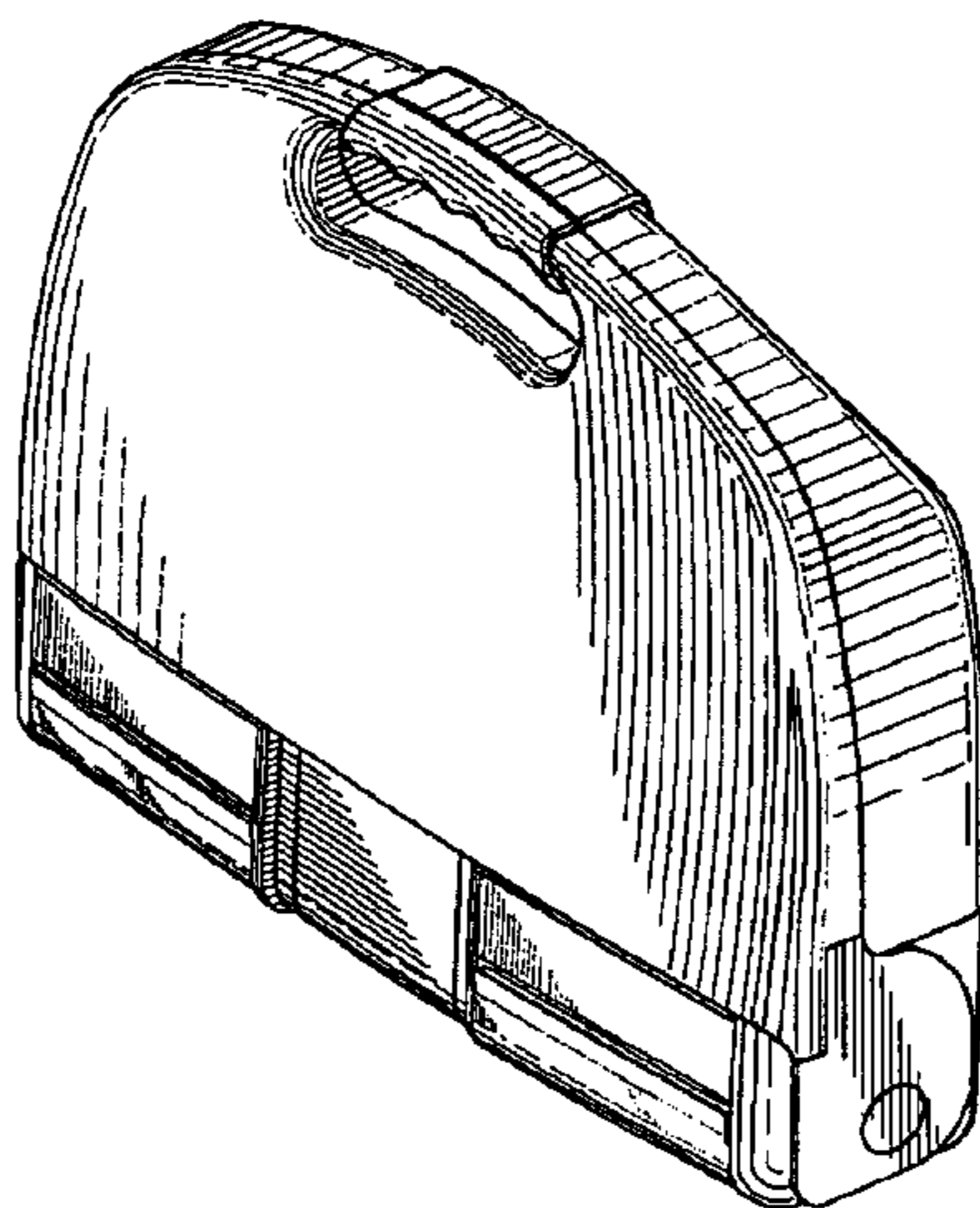

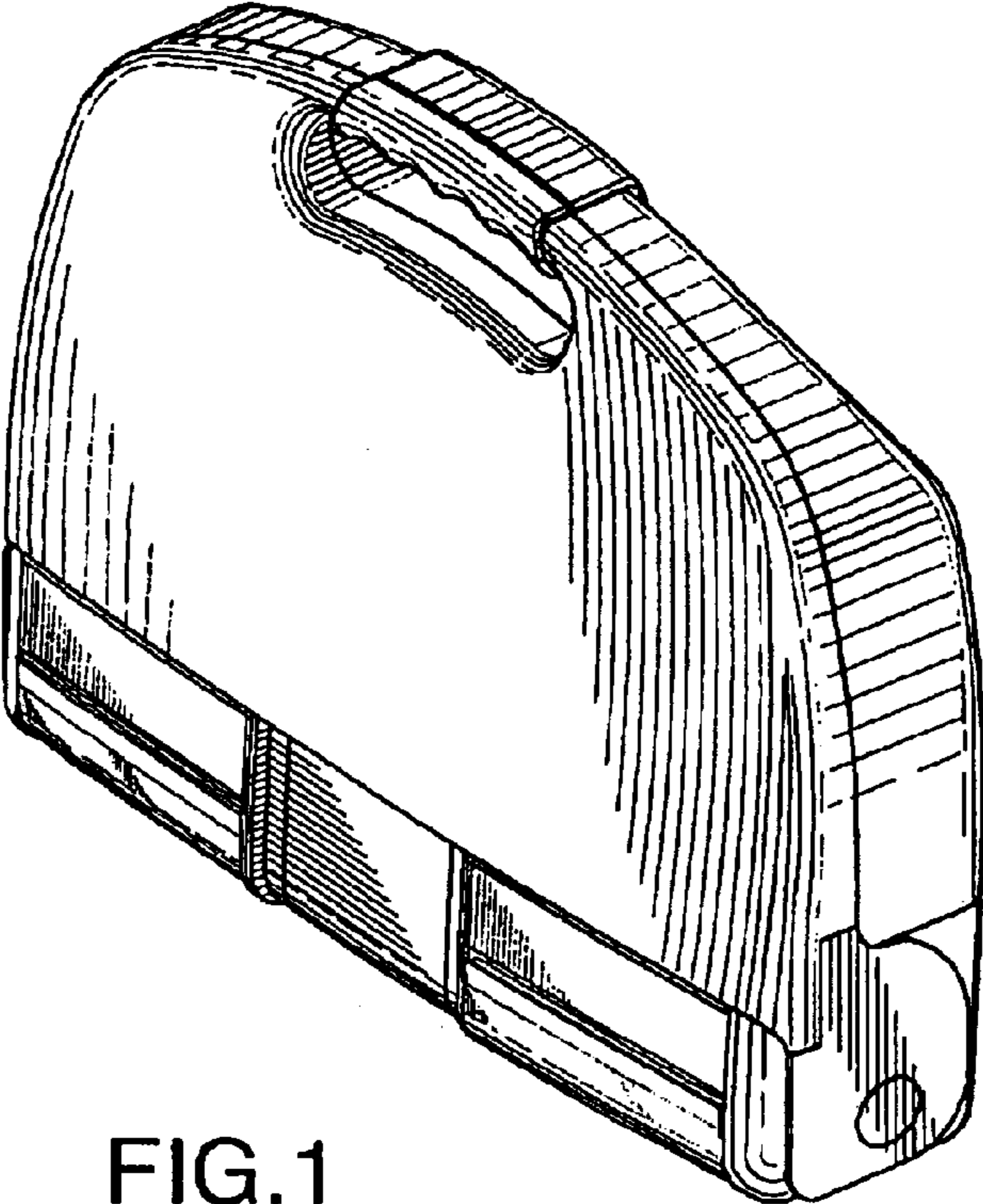

FIG.1

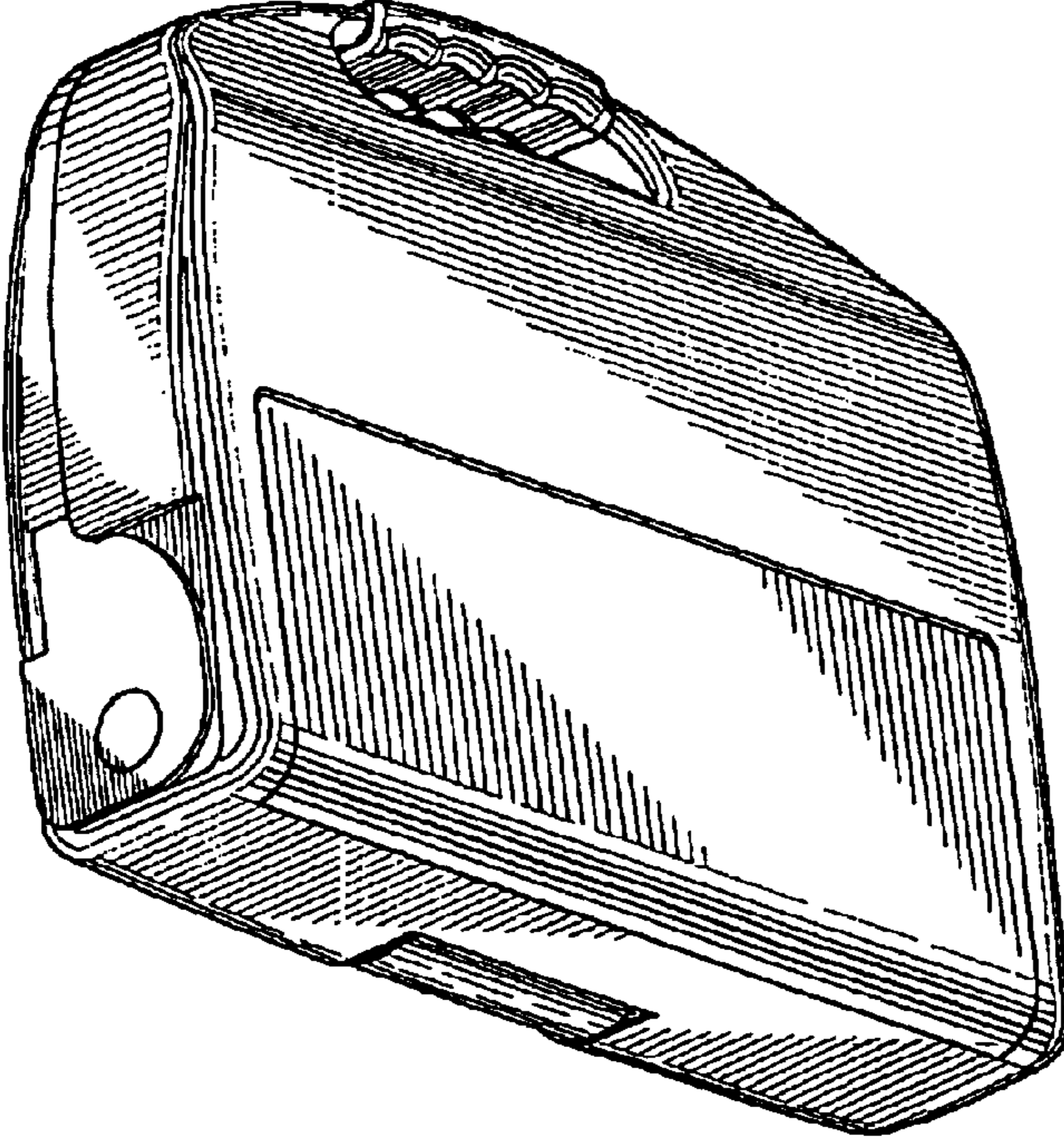

FIG.2

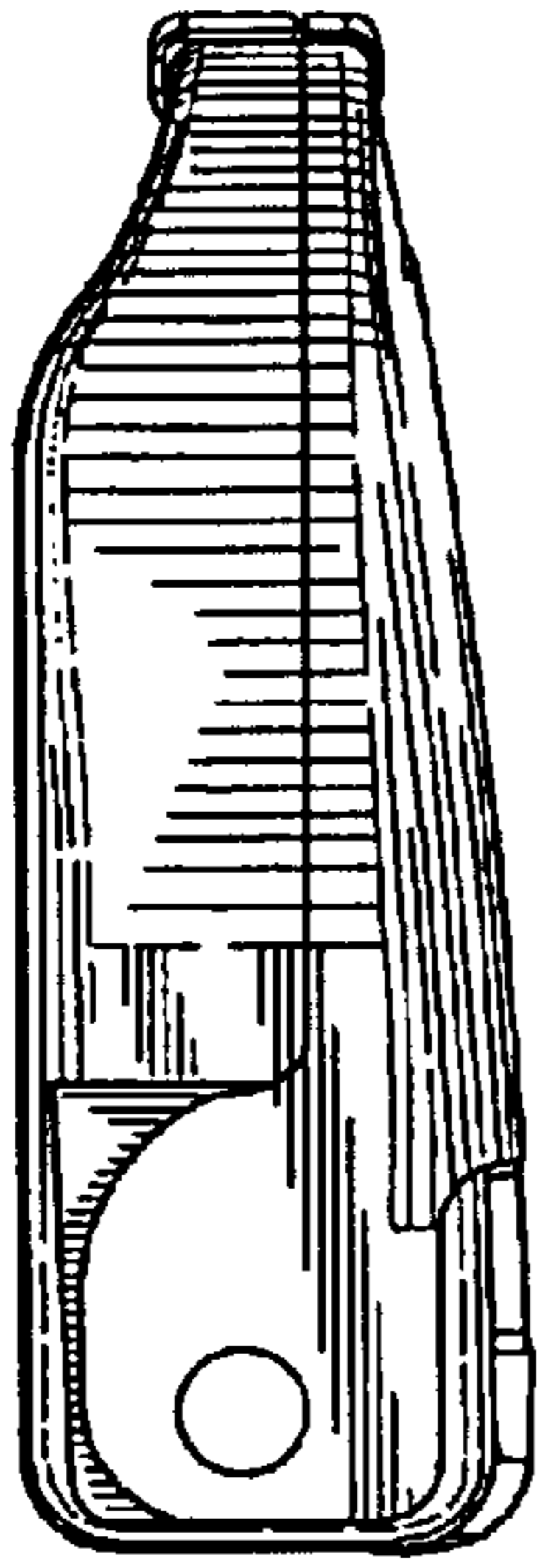

FIG. 3

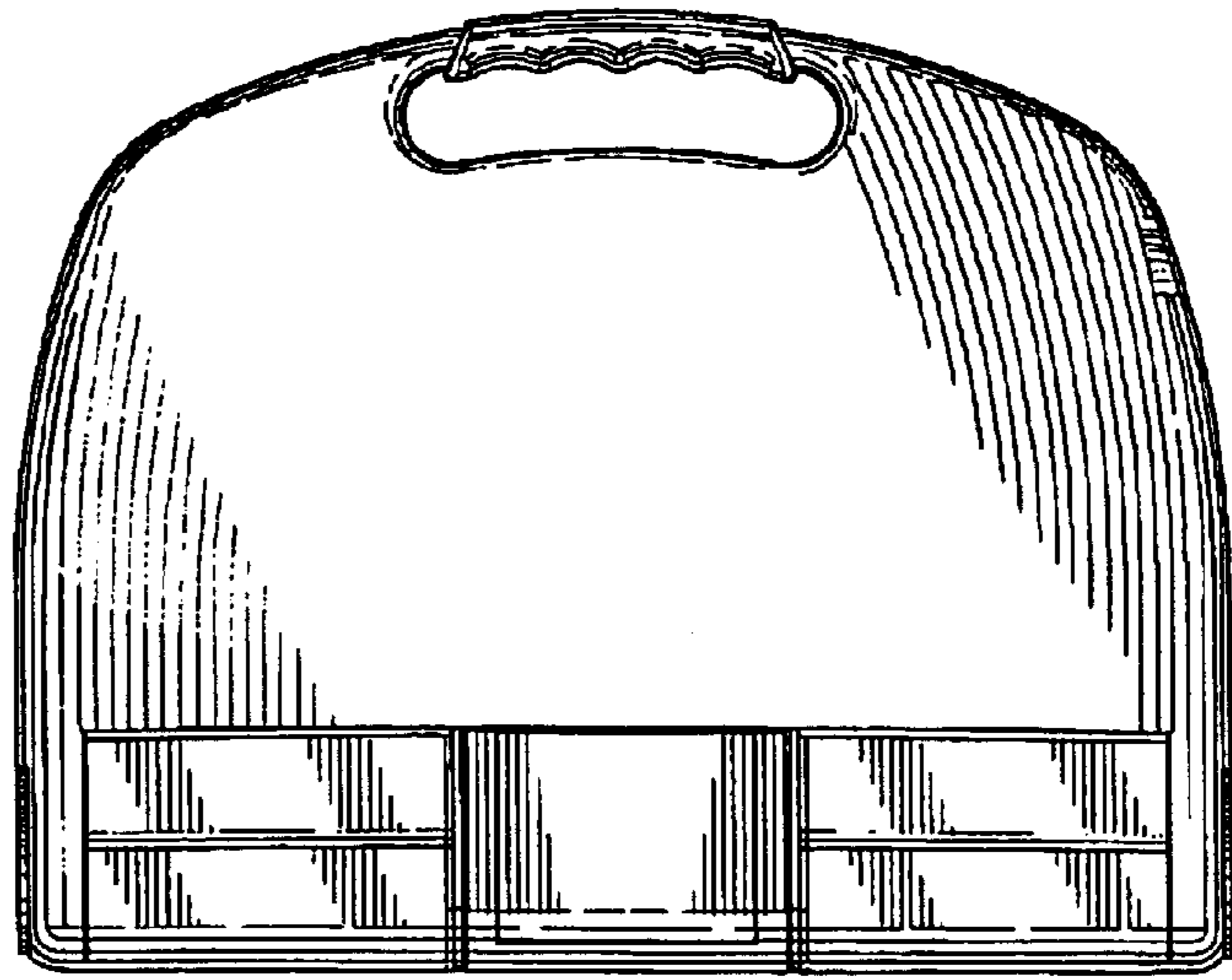

FIG. 4

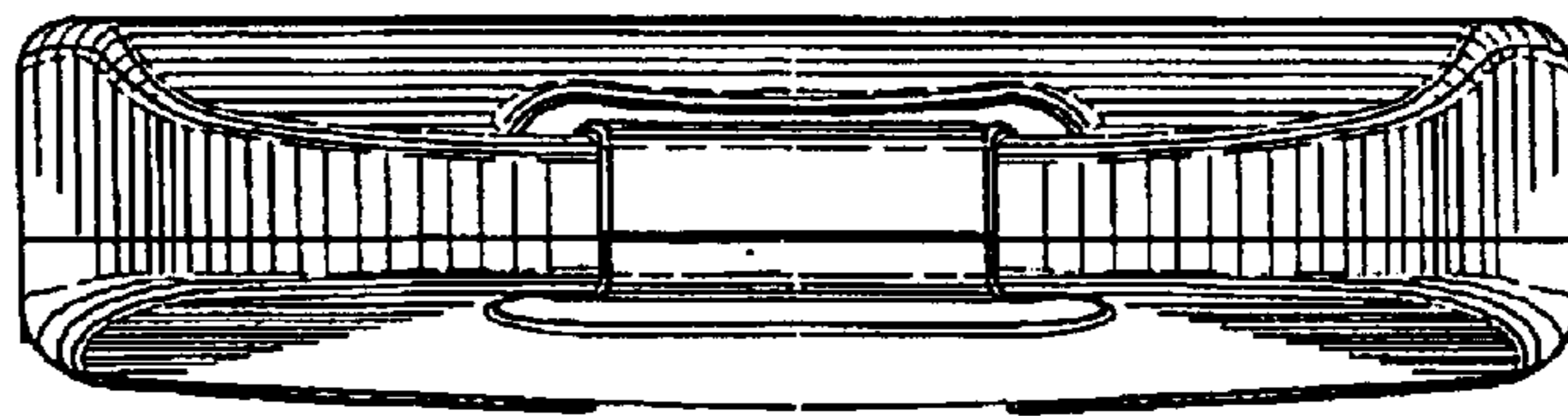

FIG. 5

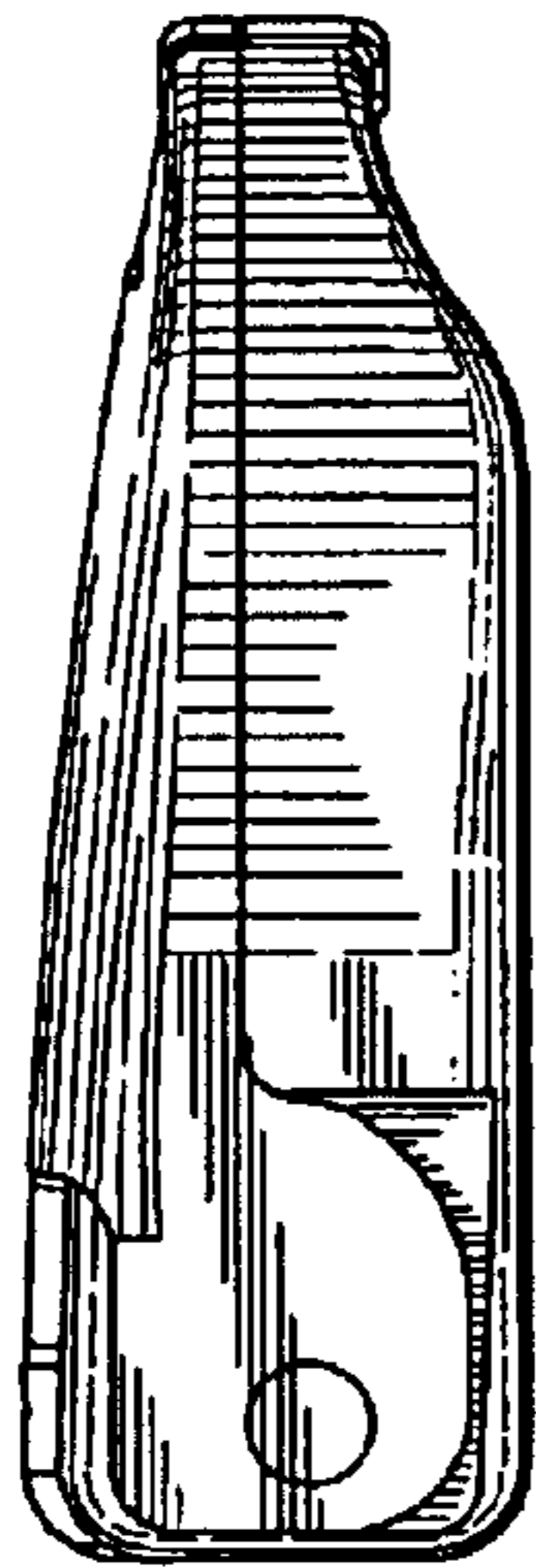

FIG. 6

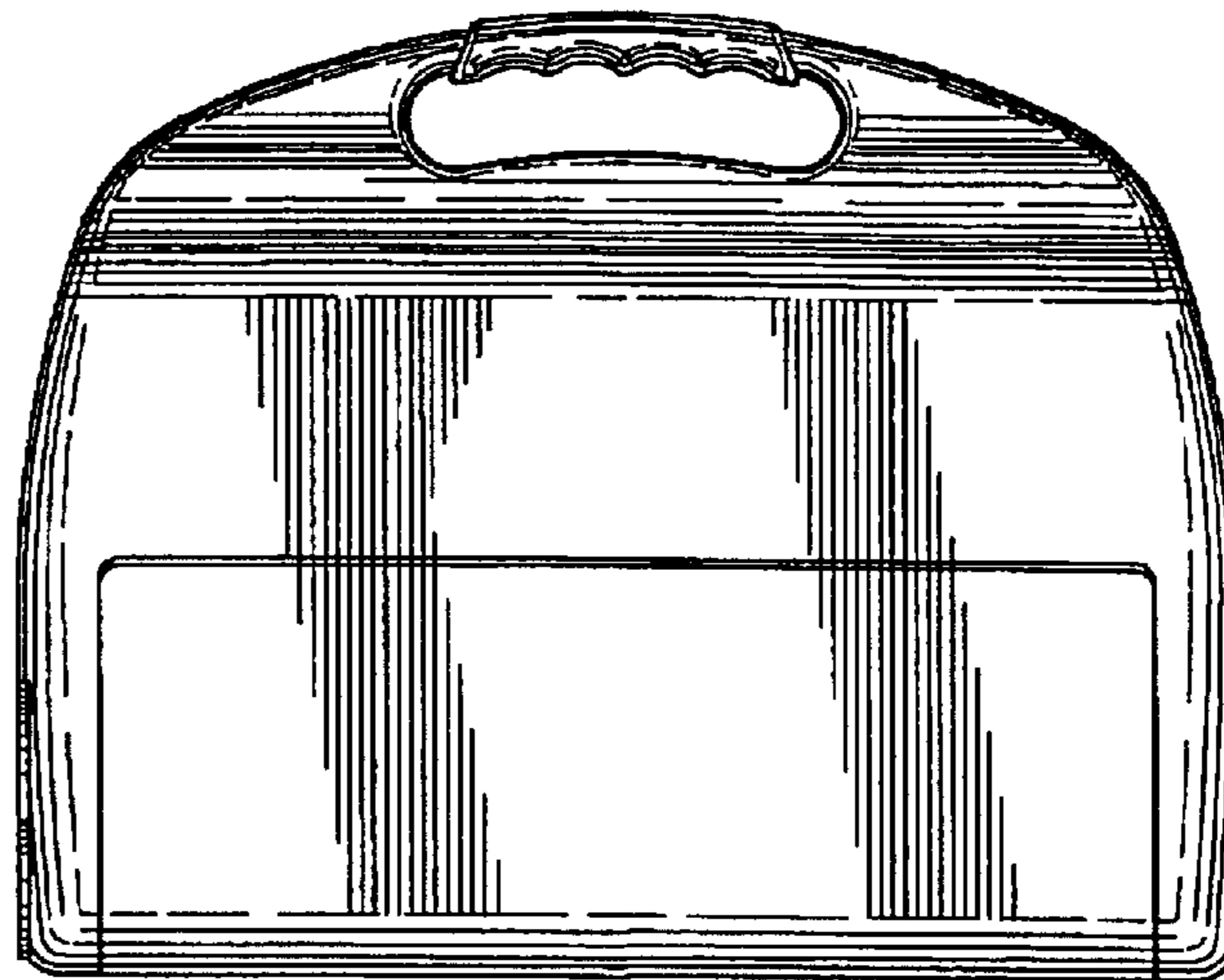

FIG. 7

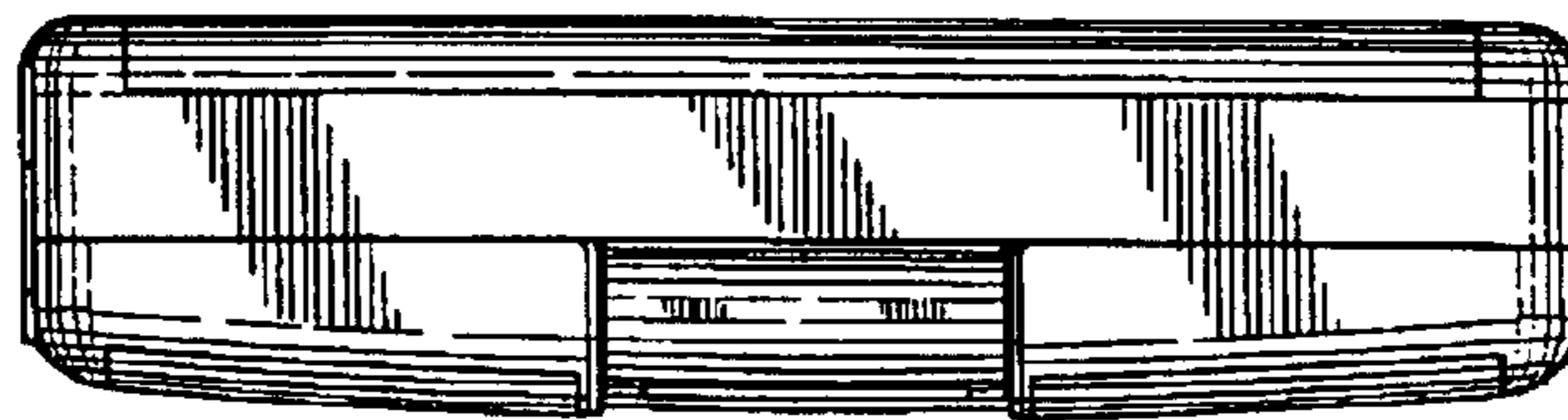

FIG. 8

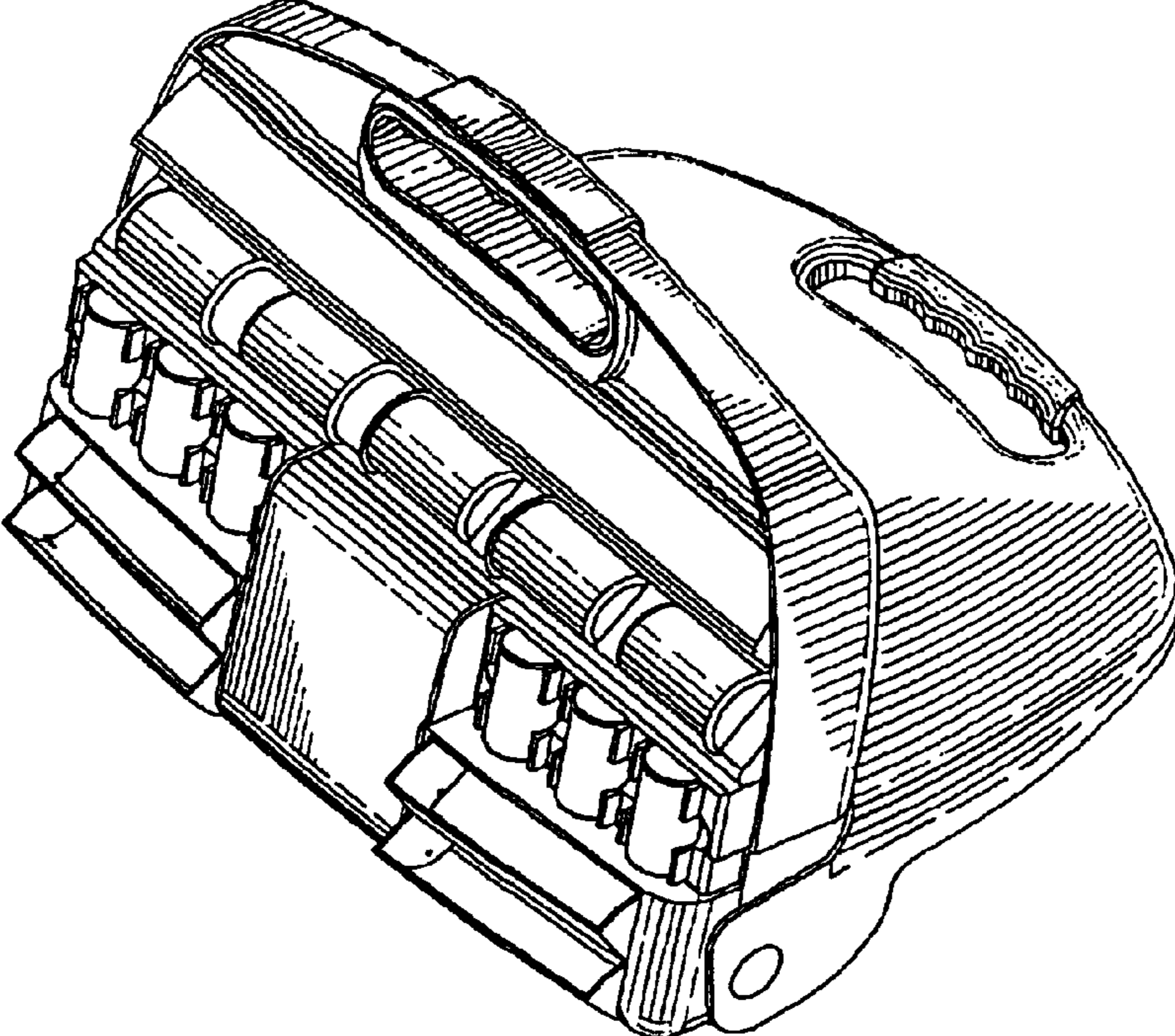

FIG. 9

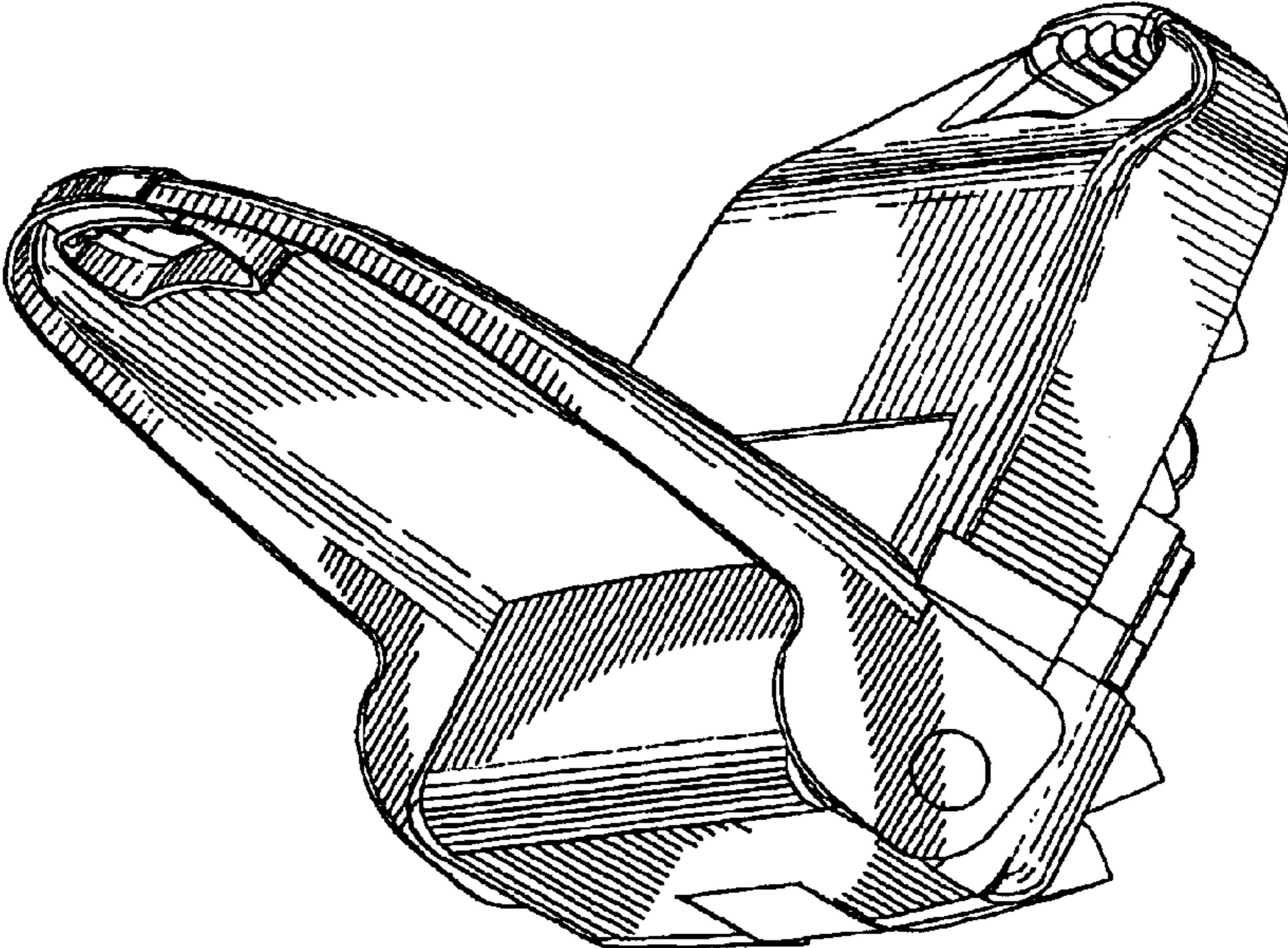

FIG. 10

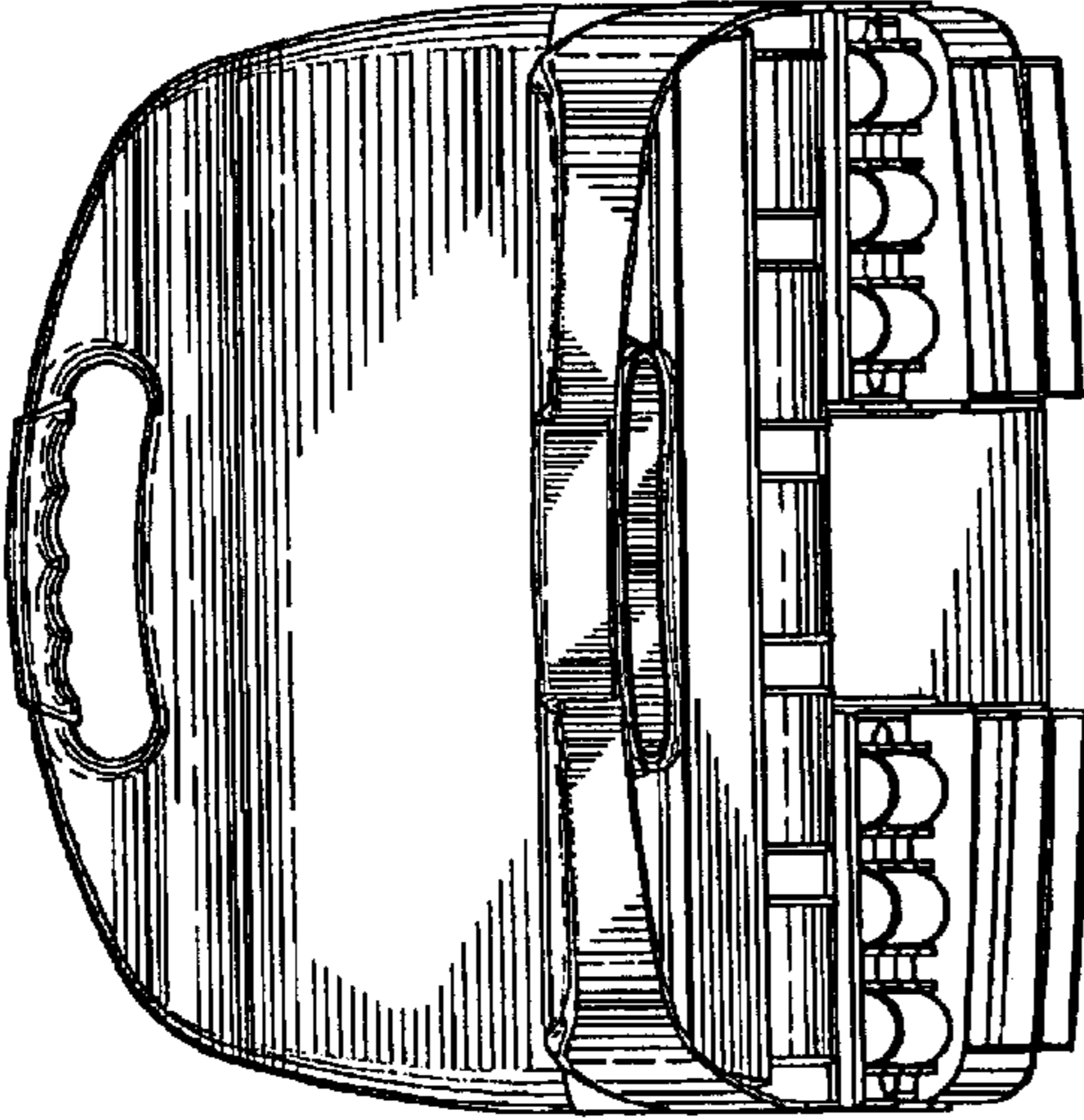

FIG. 11

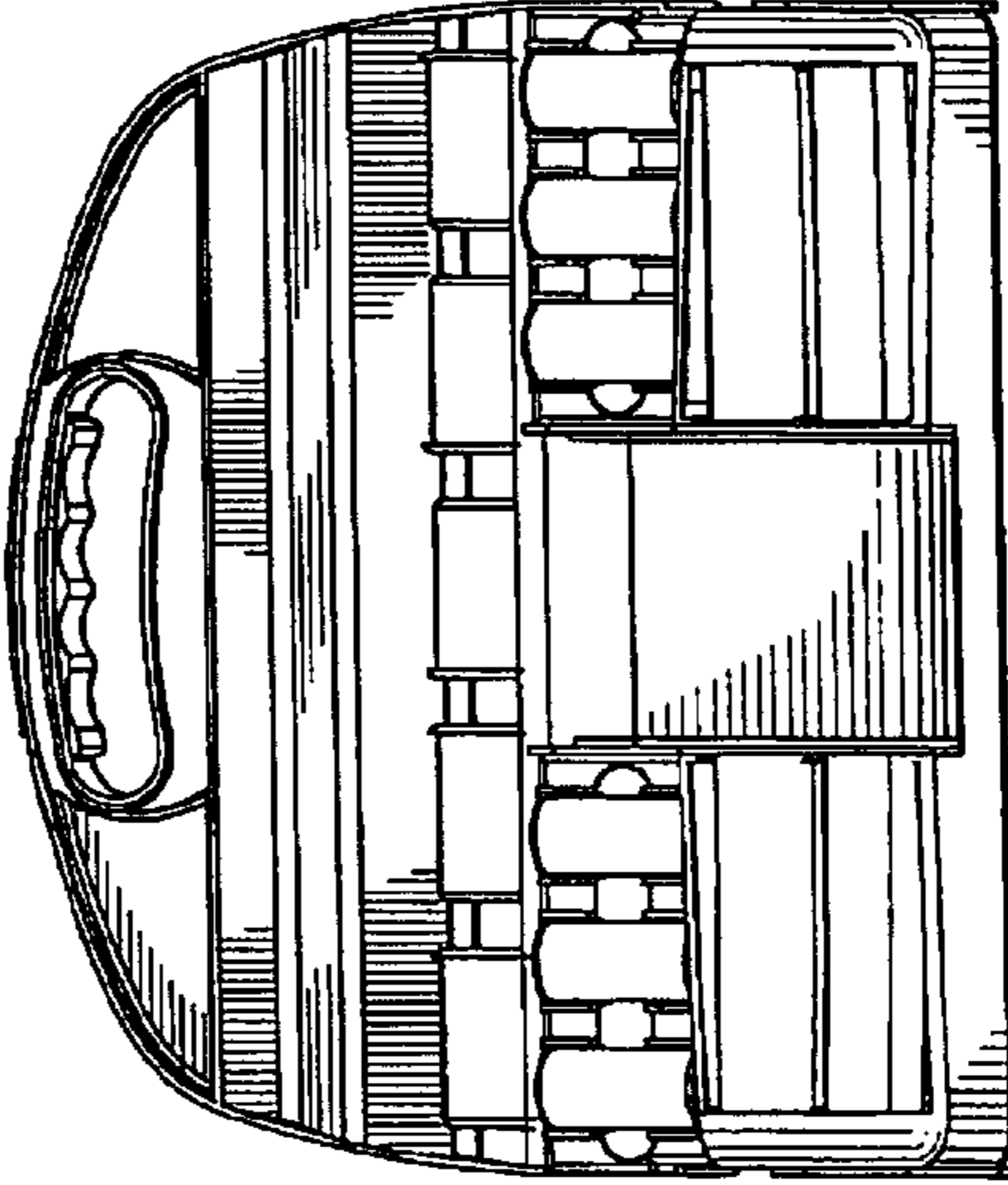

FIG. 12

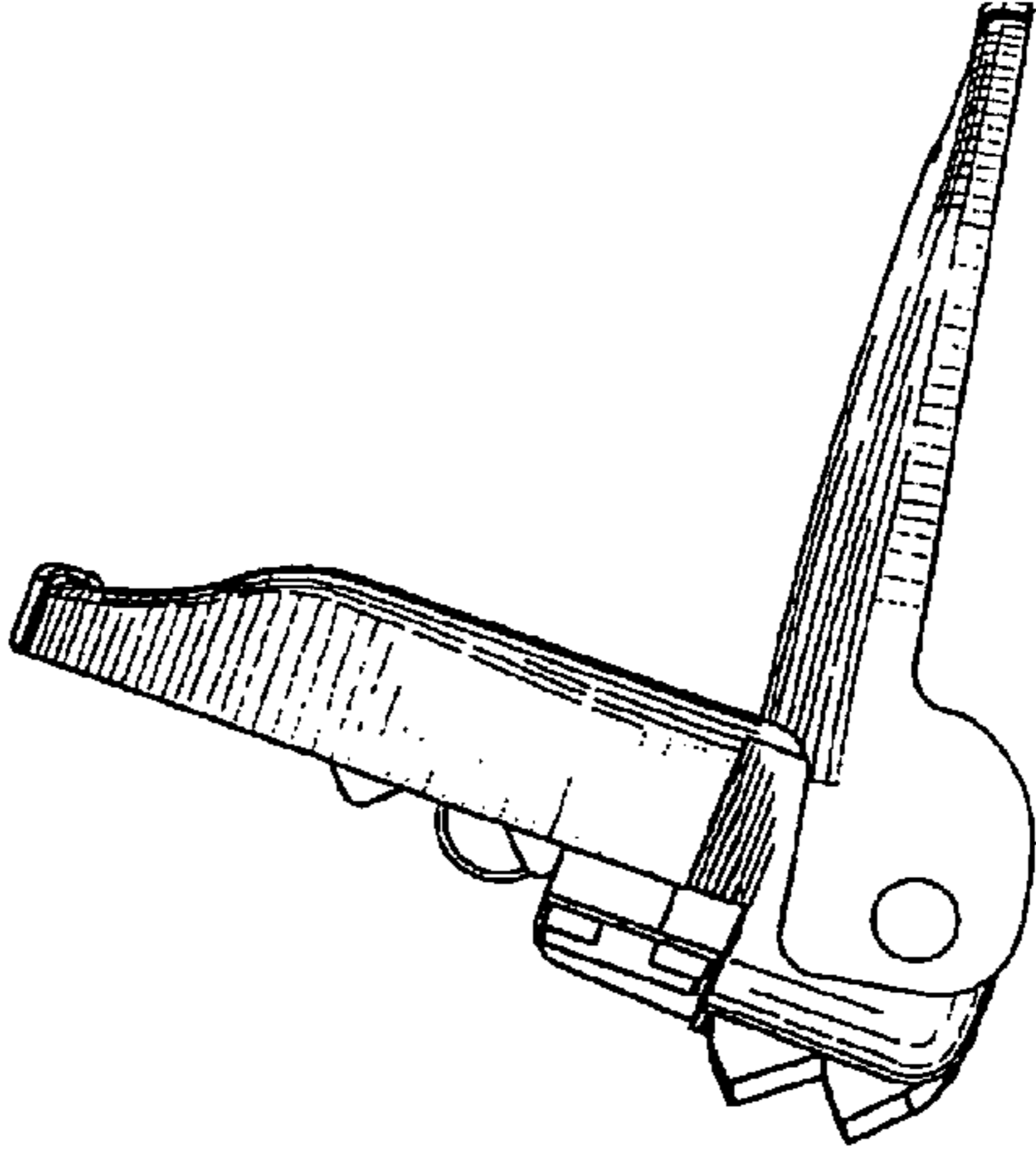

FIG. 13

FIG.15

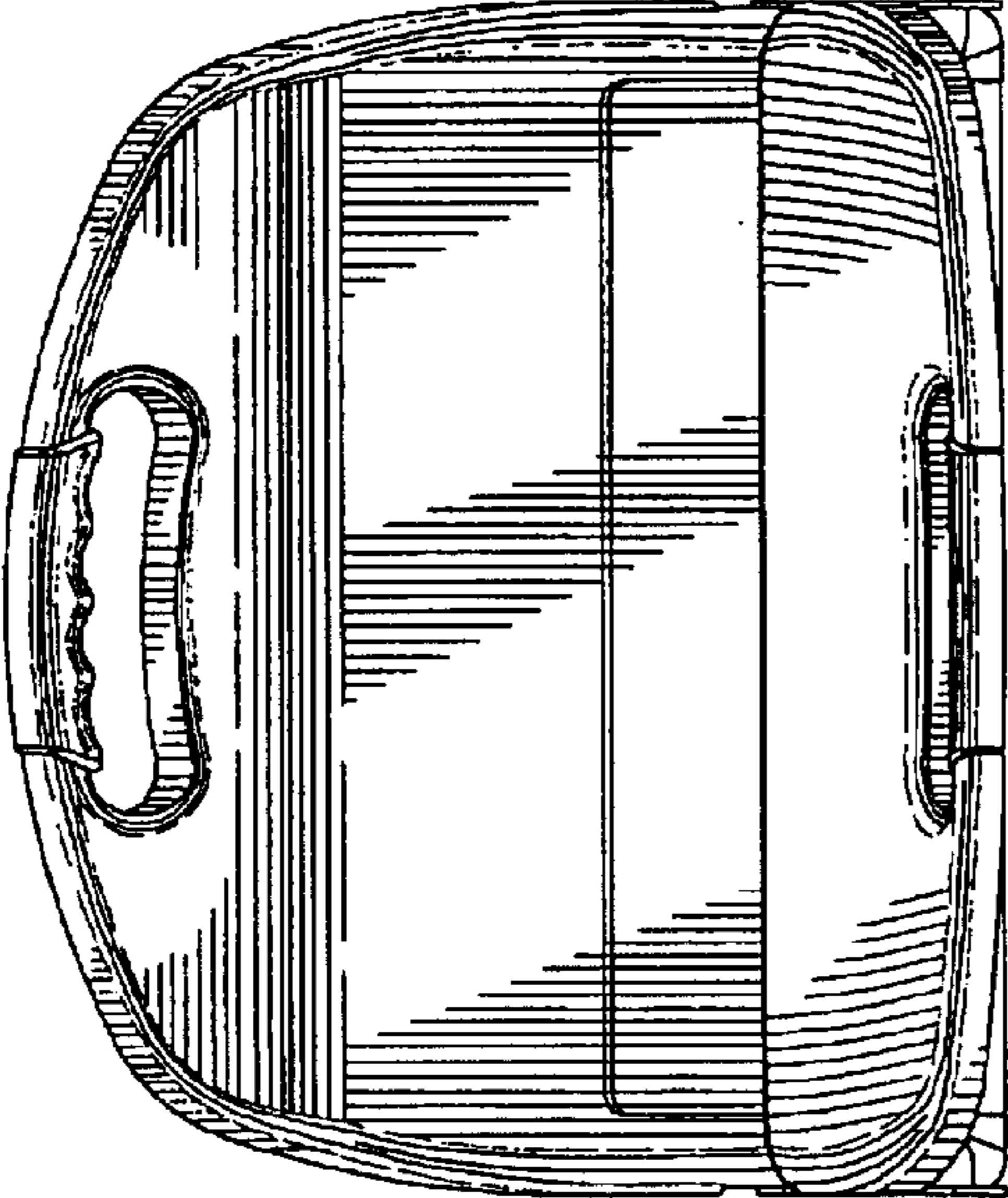

FIG.16

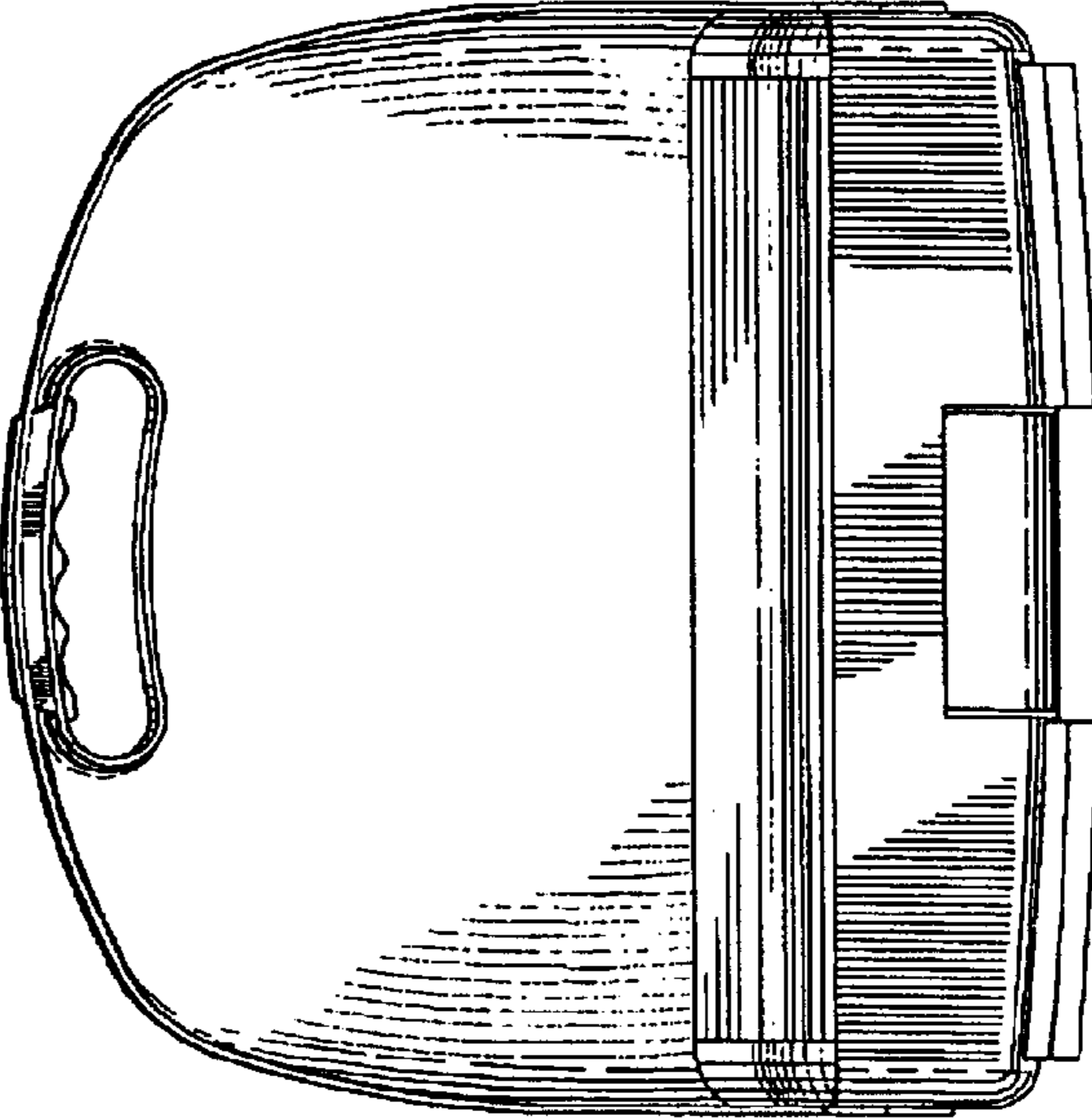

FIG.14

