



US00D514311S

(12) **United States Design Patent**
Cetera

(10) **Patent No.:** **US D514,311 S**
(45) **Date of Patent:** **** Feb. 7, 2006**

(54) **BADGE HOLDER**

(75) Inventor: **Carl Cetera**, Tenafly, NJ (US)

(73) Assignee: **Cotapaxi, INC**, Carlstadt, NJ (US)

(**) Term: **14 Years**

(21) Appl. No.: **29/218,416**

(22) Filed: **Dec. 1, 2004**

(51) **LOC (8) Cl.** **03-01**

(52) **U.S. Cl.** **D3/215**

(58) **Field of Classification Search** D3/215,
D3/207-212, 224, 226, 228; 40/1.5, 1.6;
24/3.12, 3.13, 3.11, 3.6; D8/34; 431/253
See application file for complete search history.

(56) **References Cited**

U.S. PATENT DOCUMENTS

5,864,925	A	*	2/1999	McGee	24/3.11
D458,098	S	*	6/2002	Hastings	D8/34
D465,645	S	*	11/2002	Lombardo et al.	D3/215
D471,005	S	*	3/2003	Hastings	D3/215
D485,981	S	*	2/2004	Romero	D3/215

D498,358	S	*	11/2004	Wolff	D3/215
2003/0093931	A1	*	5/2003	Cuff	40/1.6
2003/0113680	A1	*	6/2003	Genuise	431/253
2005/0011981	A1	*	1/2005	Baumgarten	40/1.5

* cited by examiner

Primary Examiner—Catherine R. Oliver

(74) *Attorney, Agent, or Firm*—Brian Carpenter

(57) **CLAIM**

The ornamental design for a badge holder, as shown and described.

DESCRIPTION

FIG. 1 is a front/right perspective view of a badge holder; FIG. 2 is a front of the badge holder of FIG. 1; FIG. 3 is a right side elevational view of the badge holder of FIG. 1 which is a mirror image of the left side elevation view; FIG. 4 is a top plan view of the badge holder of FIG. 1; FIG. 5 is a bottom plan view of the badge holder of FIG. 1; and, FIG. 6 is a rear elevation view of the badge holder of FIG. 1.

1 Claim, 2 Drawing Sheets

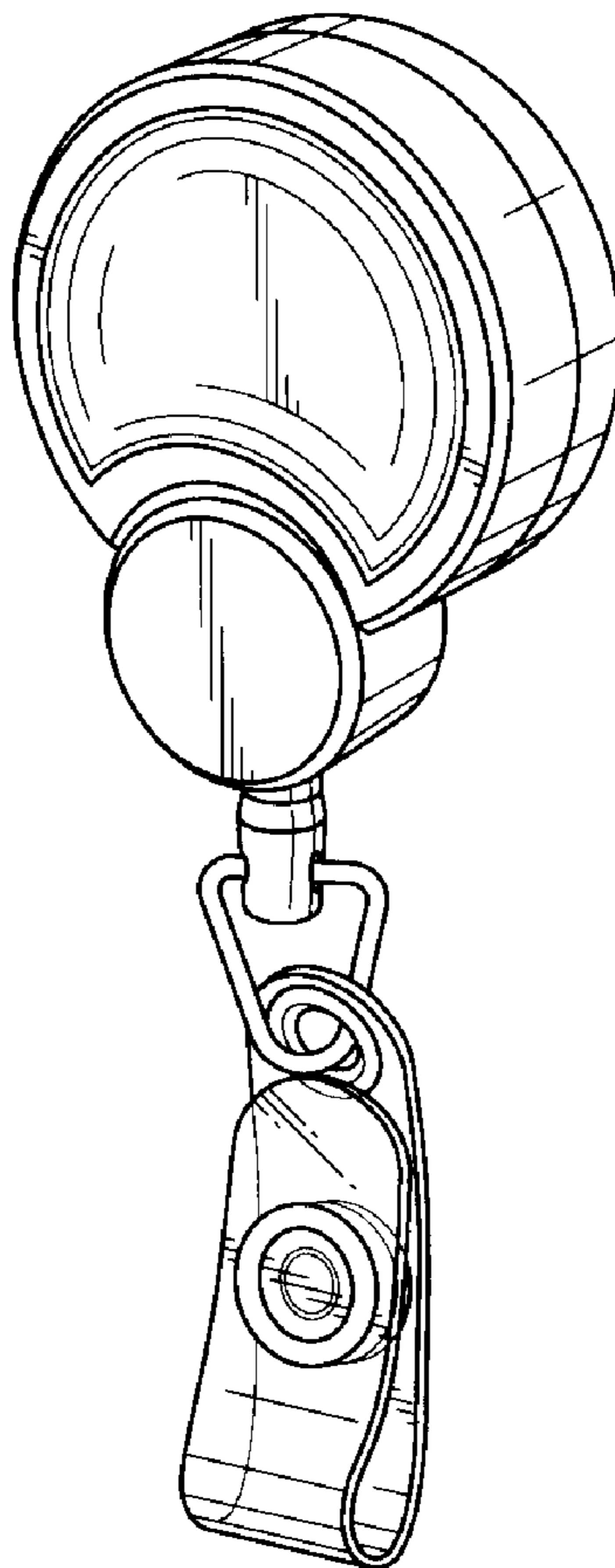

FIG. 1

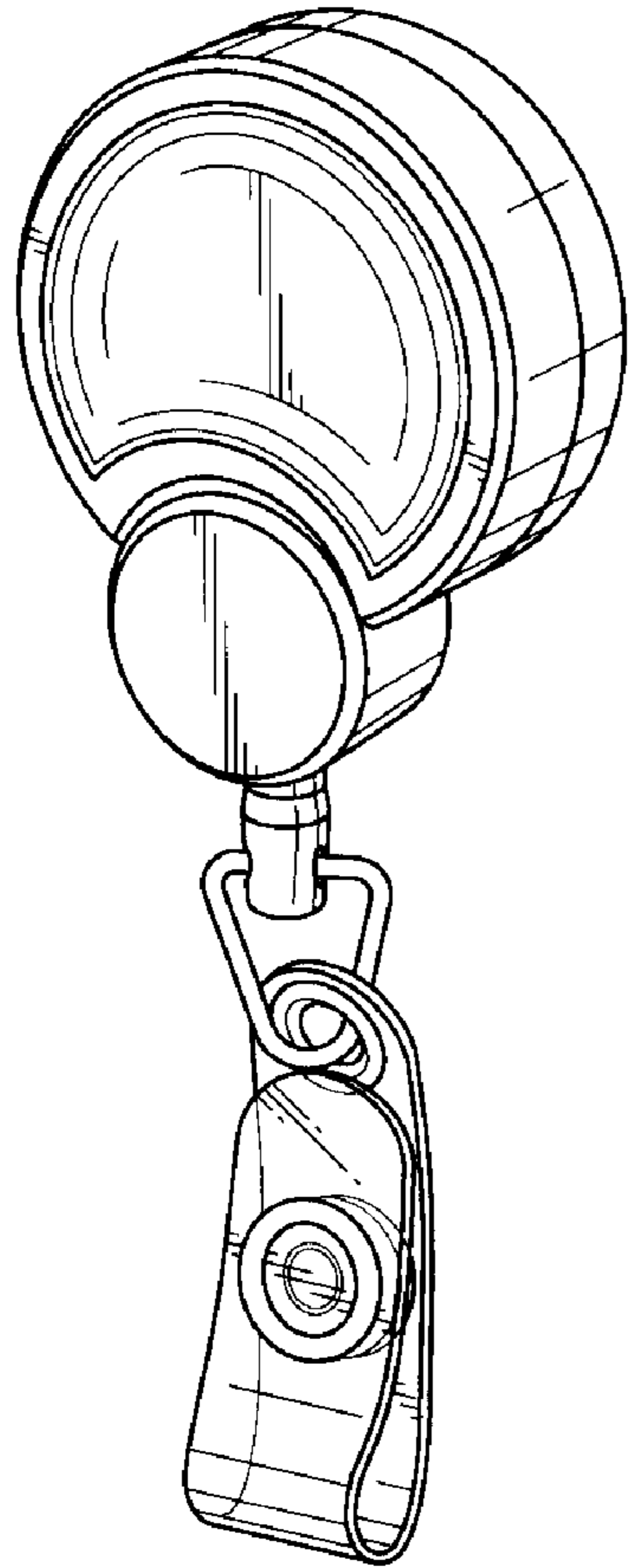

FIG. 2

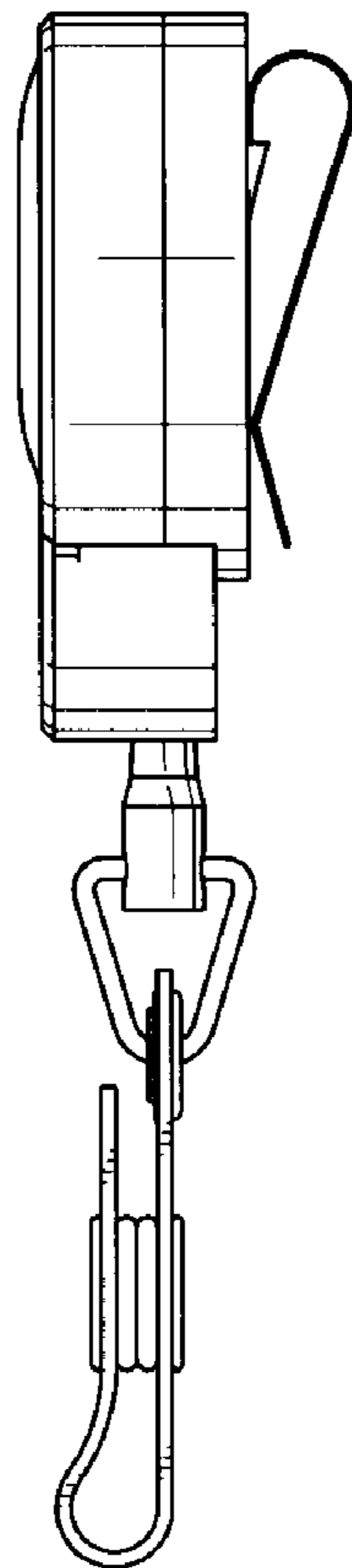
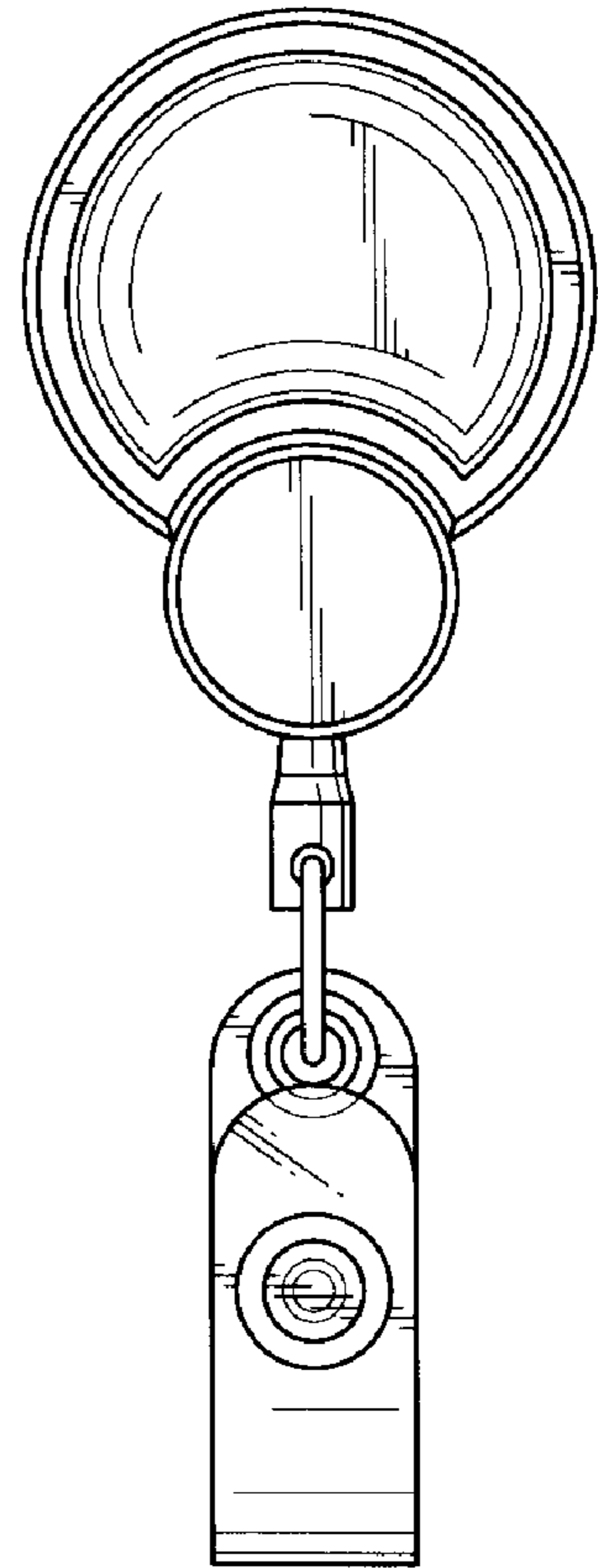

FIG. 3

FIG. 4

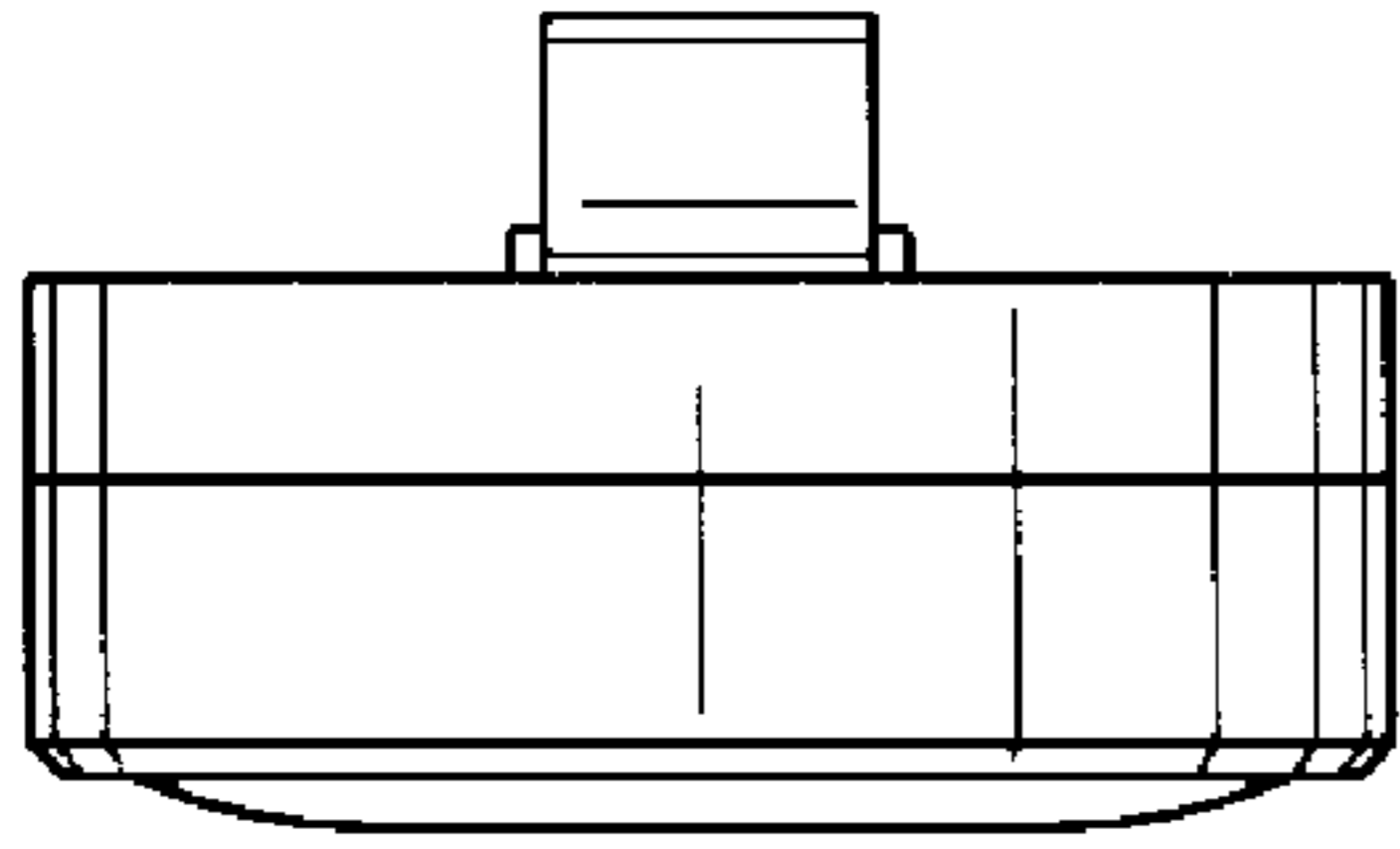

FIG. 5

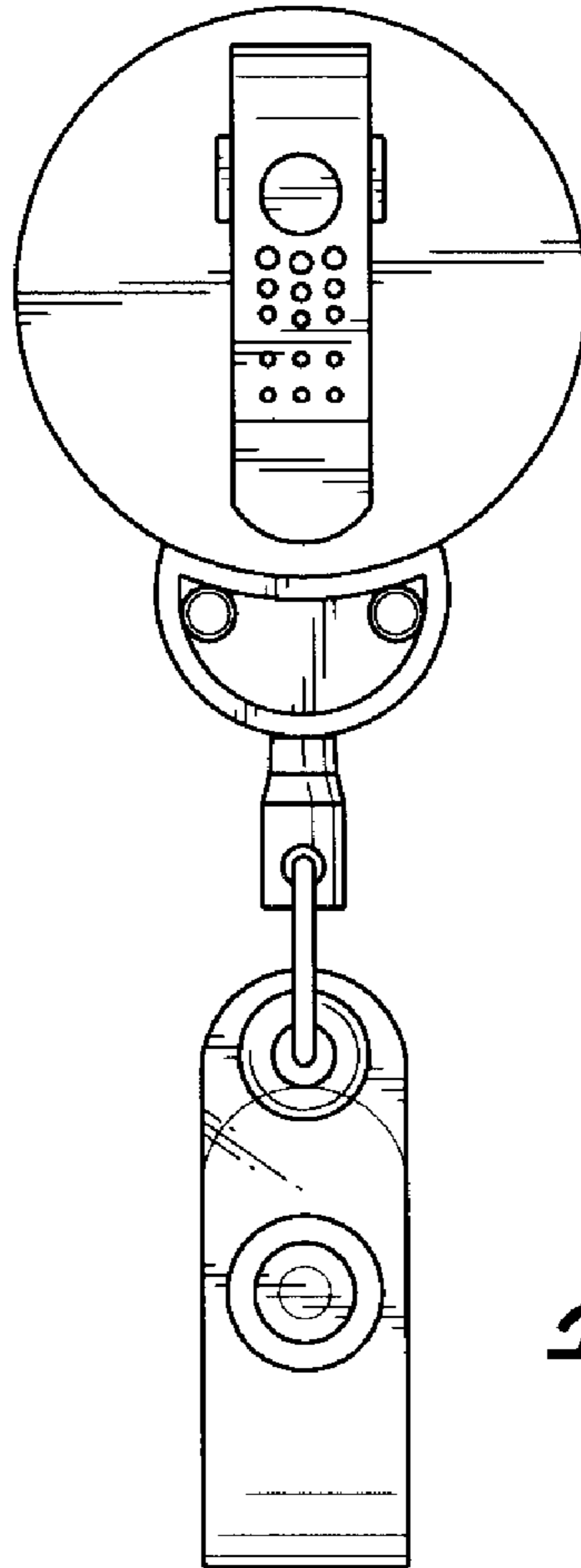
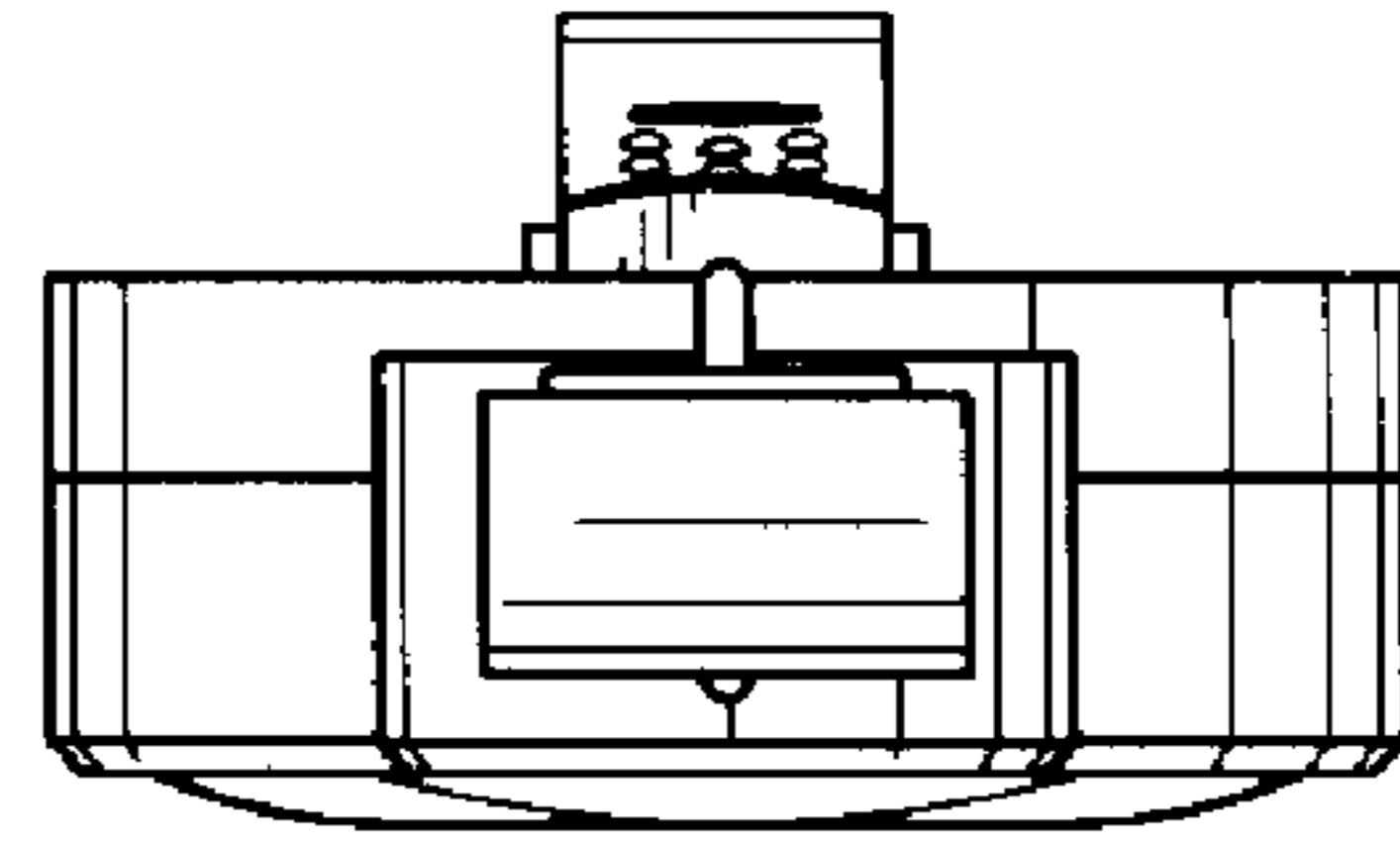

FIG. 6