

US00D514274S

(12) **United States Design Patent**
Cumpton et al.

(10) **Patent No.:** **US D514,274 S**
(45) **Date of Patent:** **** Feb. 7, 2006**

(54) **SLICED CYLINDRICAL BLOCK OF FOOD MATERIAL HAVING ONE LONGITUDINAL CUT**

(75) Inventors: **Cole A. Cumpton**, Clinton, MO (US);
Kenny D. Ramond, Lowry City, MO (US)

(73) Assignee: **Schreiber Foods, Inc.**, Green Bay, WI (US)

(**) Term: **14 Years**

(21) Appl. No.: **29/217,263**

(22) Filed: **Nov. 15, 2004**

(51) **LOC (8) Cl.** **01-01**

(52) **U.S. Cl.** **D1/121; D1/199; D1/130**

(58) **Field of Classification Search** D1/106,
D1/121, 199, 127, 129-130; D25/113; 426/130,
426/129, 414, 121, 115, 273-274, 188, 303,
426/518, 144

See application file for complete search history.

(56) **References Cited**

U.S. PATENT DOCUMENTS

D14,842 S * 3/1884 Griscom, Jr. D24/100
D56,913 S * 1/1921 Edgerton D1/100
D198,741 S * 7/1964 Kauffman, Jr. D1/129
3,900,574 A * 8/1975 Warwick 426/274

4,046,923 A * 9/1977 Meng et al. 426/130
4,278,693 A * 7/1981 Dingethal et al. 426/129
5,945,145 A * 8/1999 Narsutis et al. 426/123
6,063,416 A * 5/2000 Teasdale et al. 426/115
6,110,512 A * 8/2000 Teasdale et al. 426/121
D488,911 S * 4/2004 Childress D1/121
D495,463 S * 9/2004 Childress D1/121
D497,238 S * 10/2004 Maniak D1/129

* cited by examiner

Primary Examiner—Pamela Burgess

(74) *Attorney, Agent, or Firm*—Brinks Hofer Gilson & Lione

(57) **CLAIM**

The ornamental design for a sliced cylindrical block of food material having one longitudinal cut, as shown and described.

DESCRIPTION

FIG. 1 is a side perspective view of a sliced cylindrical block of food material having one longitudinal cut, showing our new design;

FIG. 2 is a front end view thereof;

FIG. 3 is a back end view thereof;

FIG. 4 is a right side view thereof;

FIG. 5 is a left side view thereof; and,

FIG. 6 is a top side view thereof, which is identical to a bottom side view thereof.

1 Claim, 4 Drawing Sheets

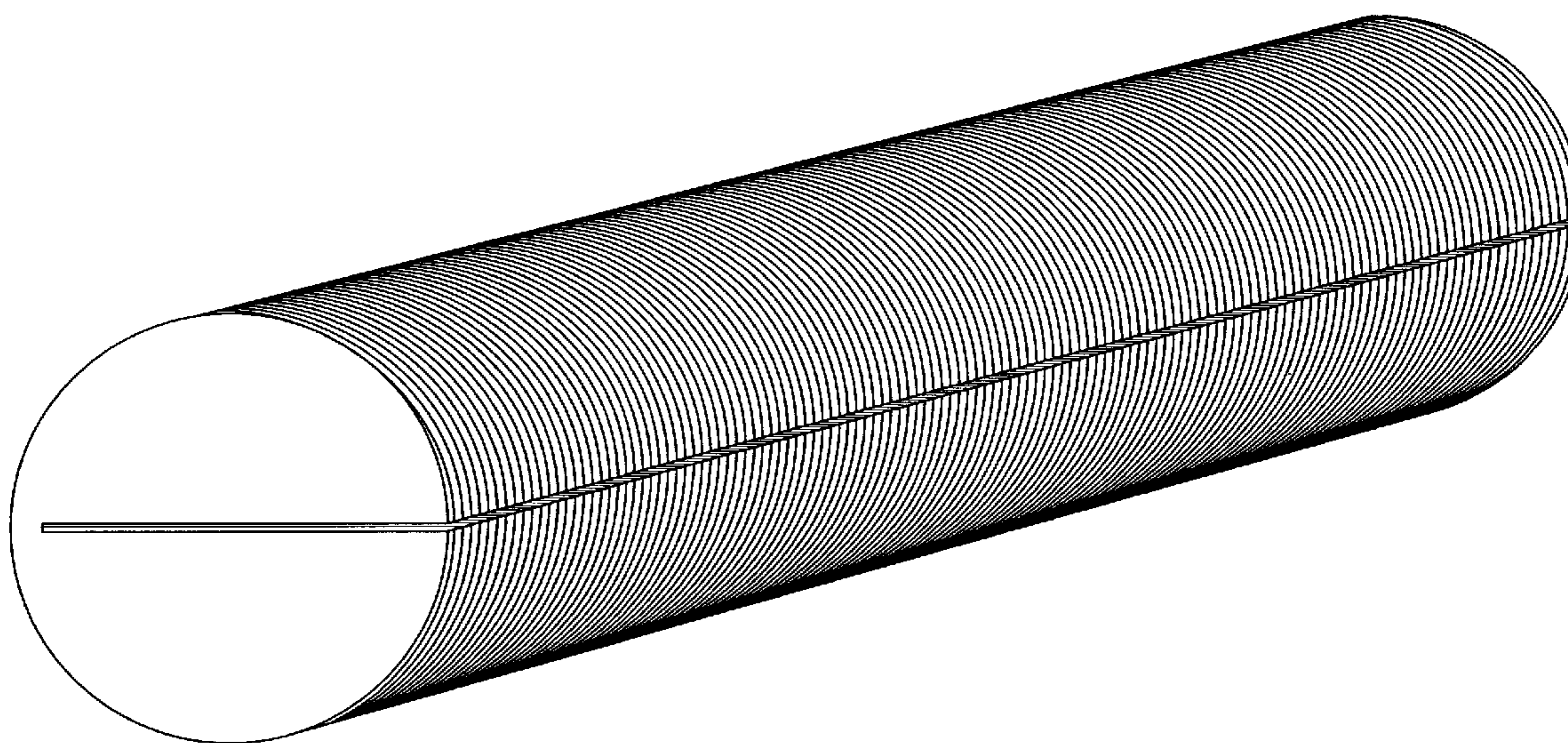

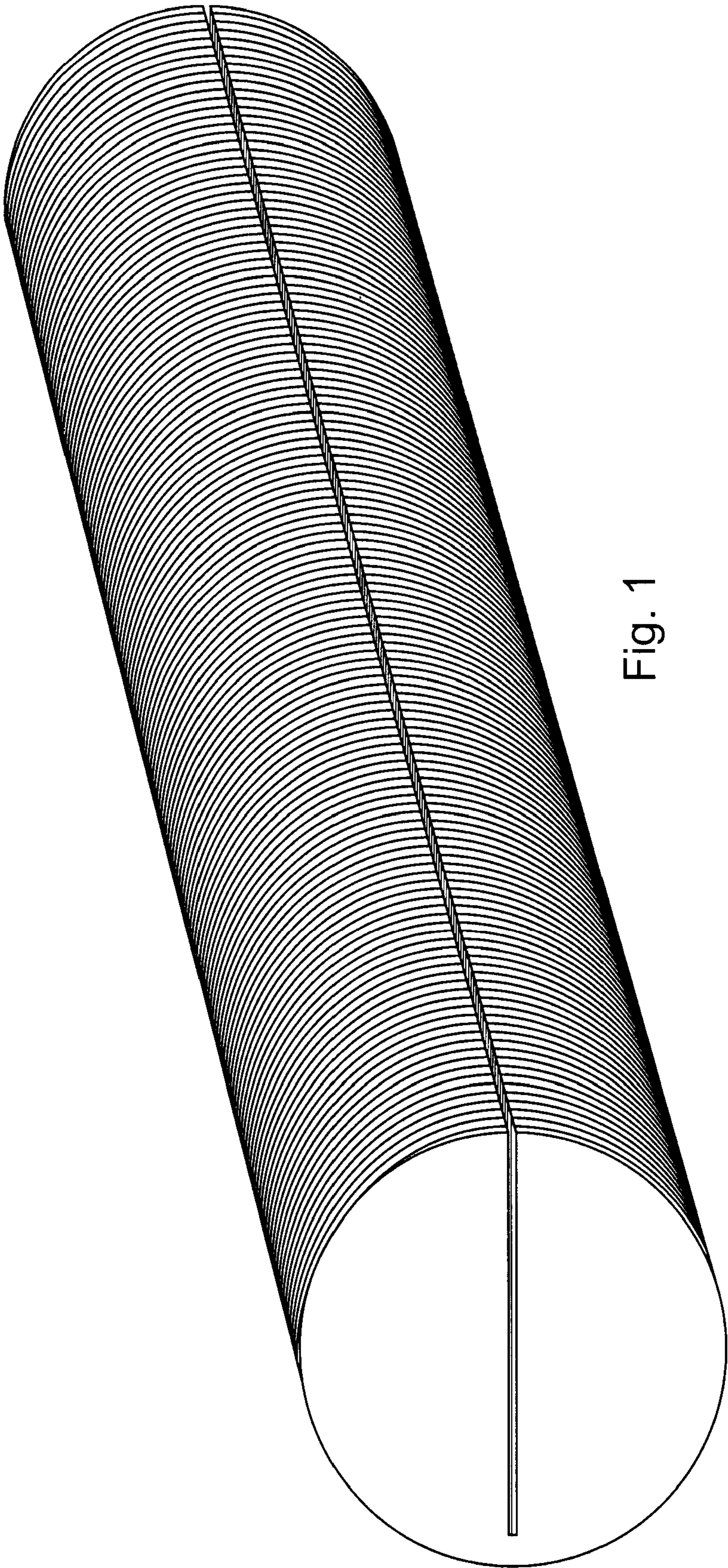

Fig. 1

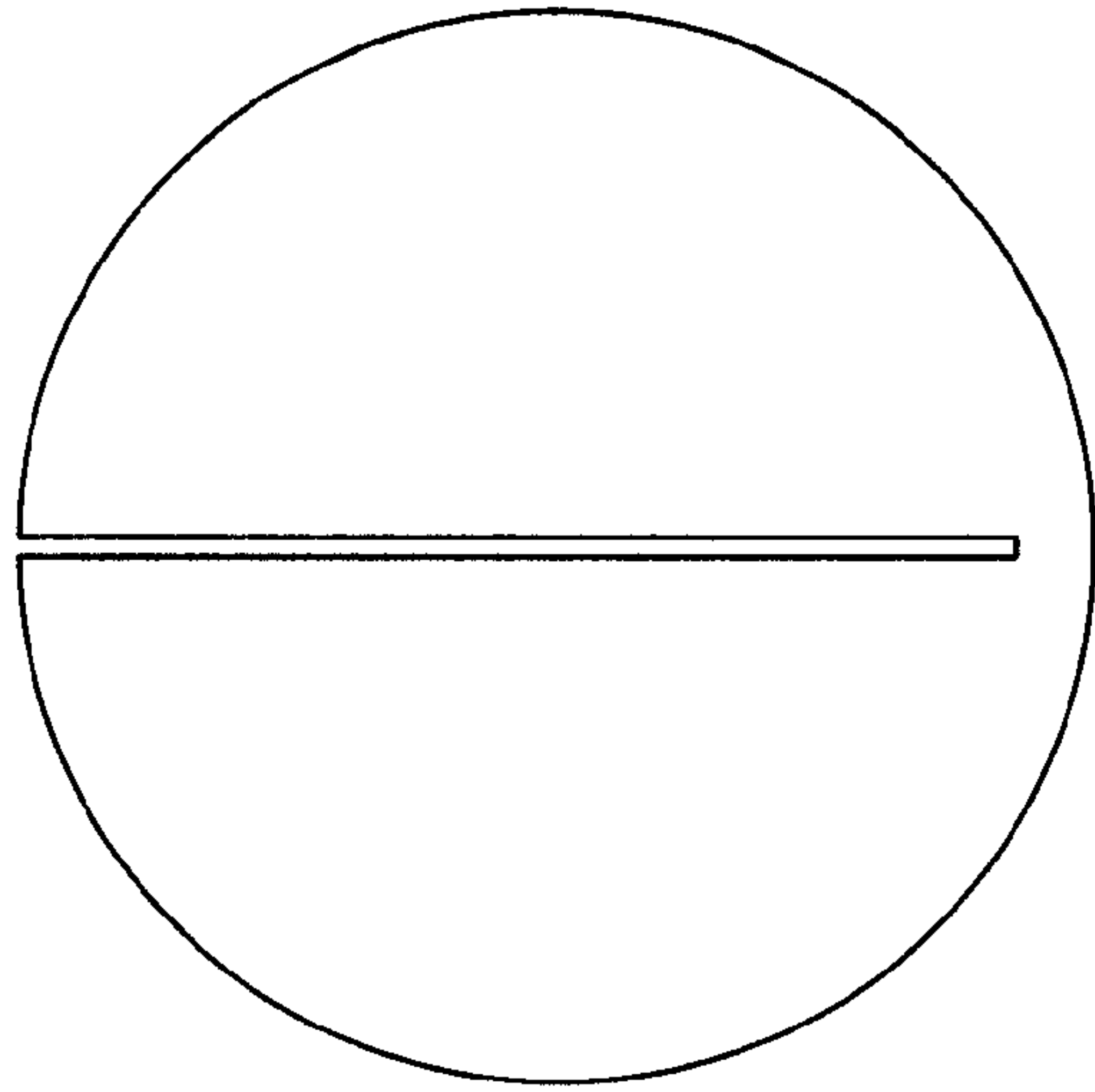

Fig. 2

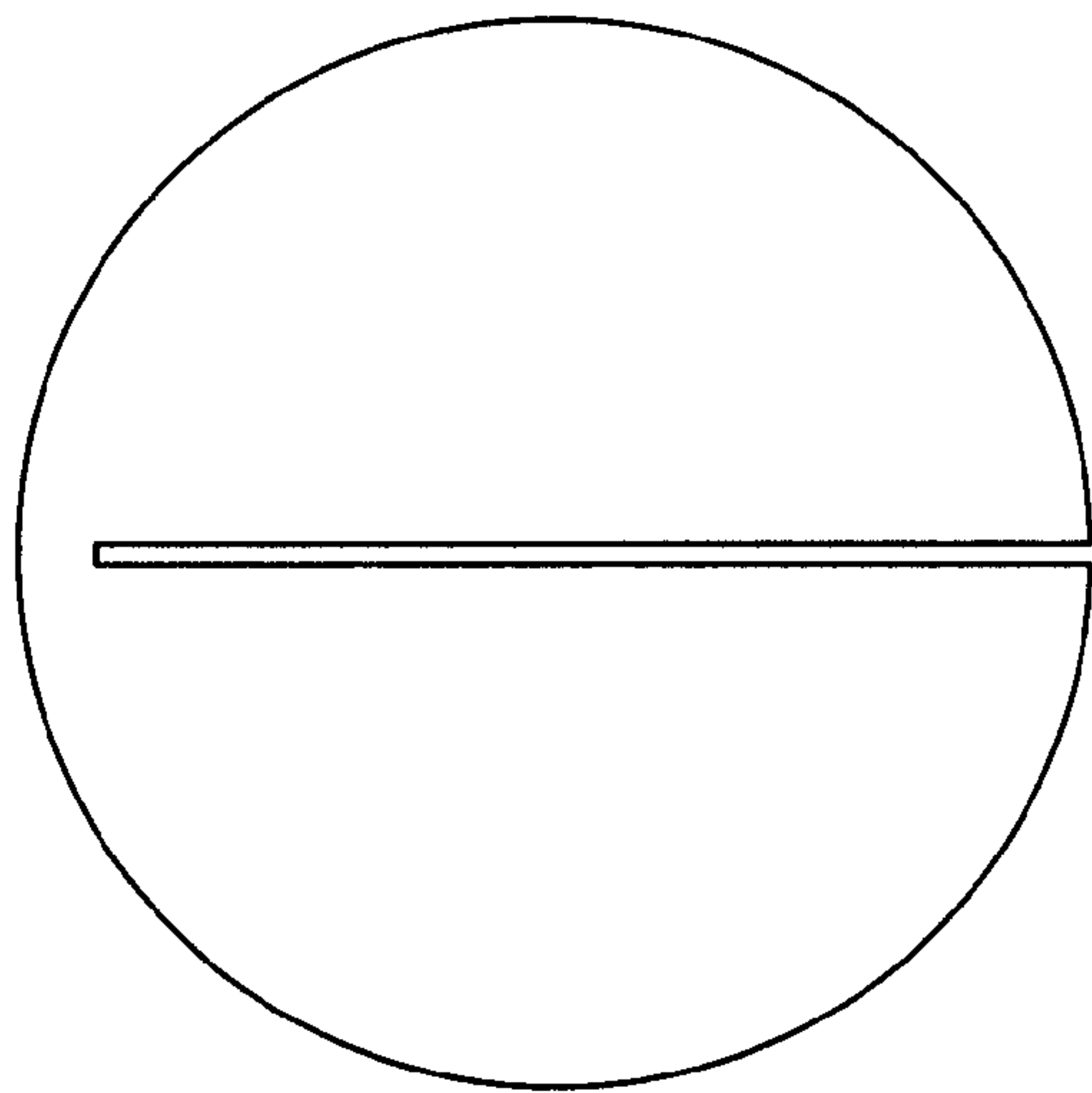

Fig. 3

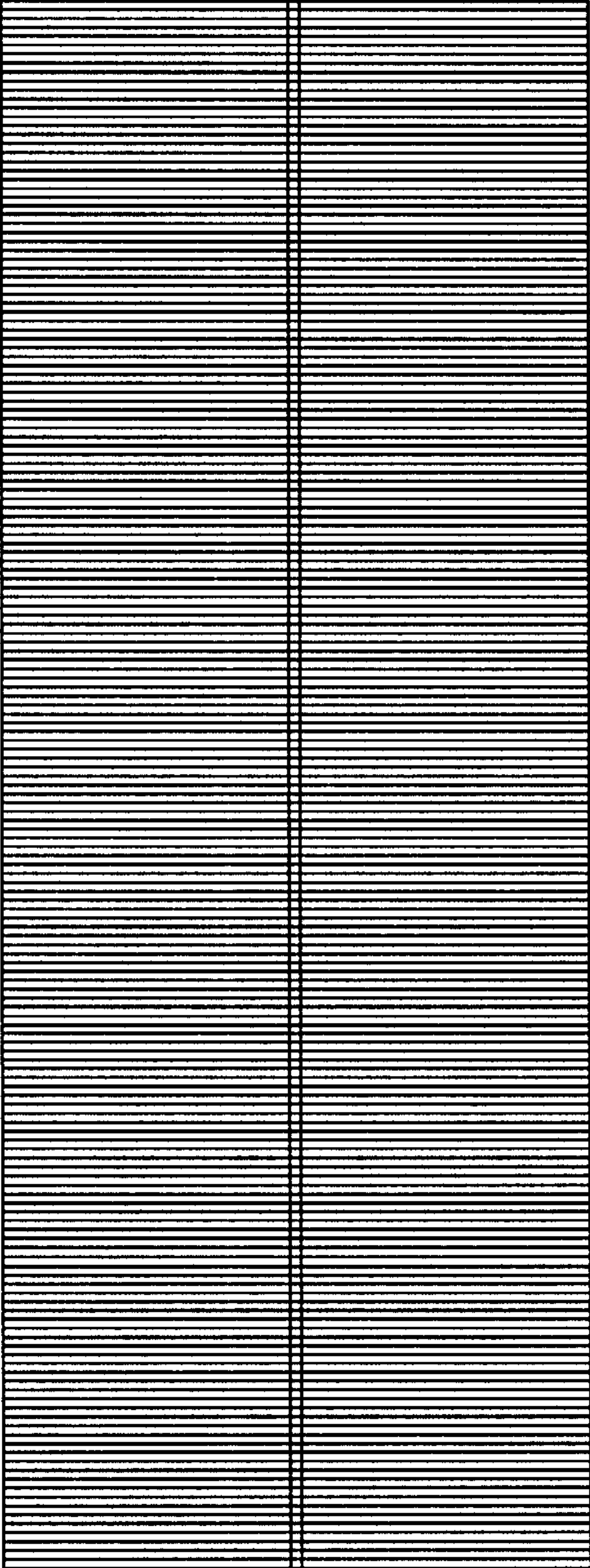

Fig. 4

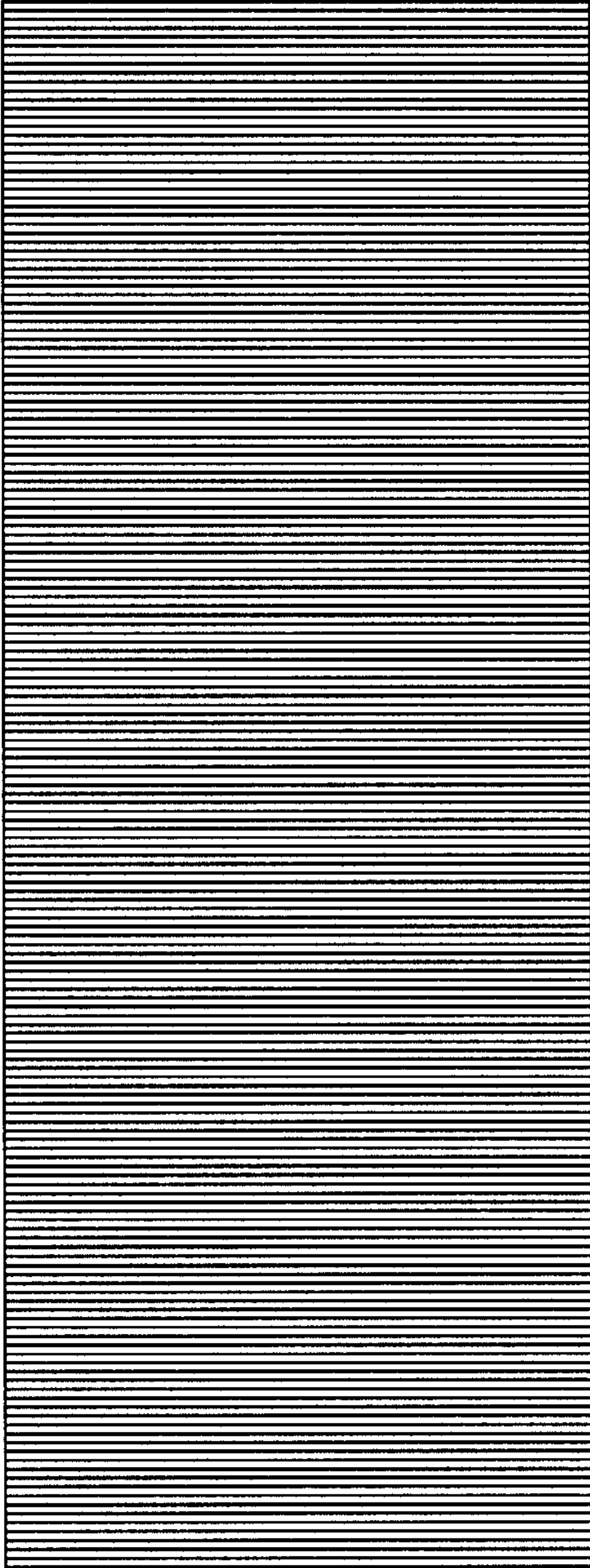

Fig. 5

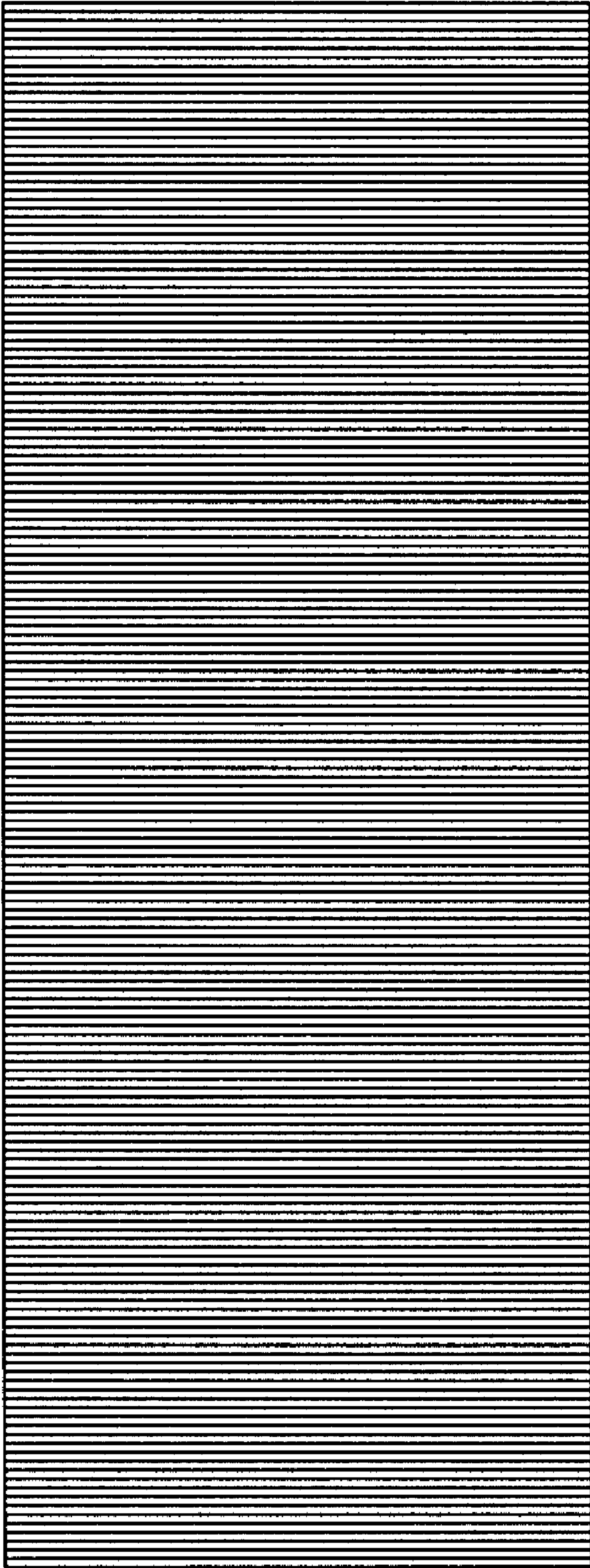

Fig. 6

UNITED STATES PATENT AND TRADEMARK OFFICE
CERTIFICATE OF CORRECTION

PATENT NO. : Des. 514,274 S
APPLICATION NO. : 29/217263
DATED : February 7, 2006
INVENTOR(S) : Cole A. Cumpton et al.

Page 1 of 1

It is certified that error appears in the above-identified patent and that said Letters Patent is hereby corrected as shown below:

On the Title Page

Item (75), replace “**Kenny D. Ramond**” with --**Kenny D. Raymond**--.

Signed and Sealed this

Ninth Day of November, 2010

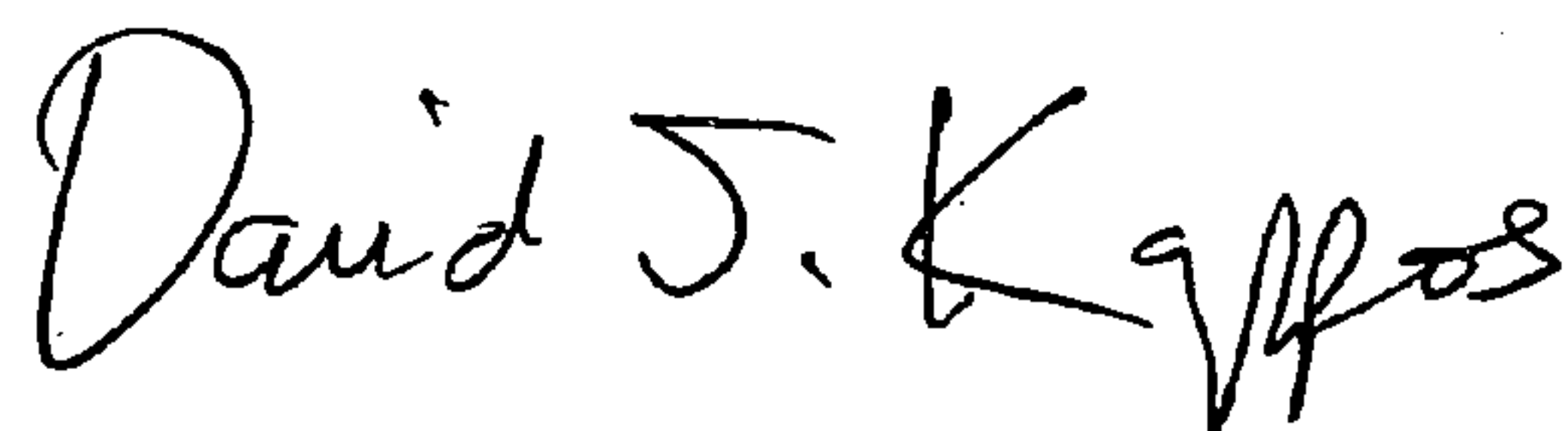
A handwritten signature in black ink that reads "David J. Kappos". The signature is written in a cursive, flowing style.

David J. Kappos
Director of the United States Patent and Trademark Office