



US00D514252S

(12) **United States Design Patent**
Shin

(10) **Patent No.:** **US D514,252 S**

(45) **Date of Patent:** **** Jan. 31, 2006**

(54) **ELECTRIC HAIR STRAIGHTENER**

(76) **Inventor:** **Kil Seung Shin**, 1060-5, Wolmun-1li,
Wabu-eup, Namyangju-si, Gyeonggi-Do
(KR)

(**) **Term:** **14 Years**

(21) **Appl. No.:** **29/210,670**

(22) **Filed:** **Aug. 4, 2004**

(30) **Foreign Application Priority Data**

Feb. 4, 2004 (KR) 30-2004-0002770

(51) **LOC (8) Cl.** **28-03**

(52) **U.S. Cl.** **D28/35**

(58) **Field of Classification Search** D28/35-37;
219/222, 225, 226; 132/223-226, 229, 232,
132/269, 271

See application file for complete search history.

(56) **References Cited**

U.S. PATENT DOCUMENTS

6,622,735 B2 * 9/2003 Hirata et al. 132/224

D489,483 S * 5/2004 Cho D28/35

2002/0190047 A1 * 12/2002 Nam 219/222

* cited by examiner

Primary Examiner—Jennifer Rivard

(74) *Attorney, Agent, or Firm*—Osha & Long LLP

(57) **CLAIM**

The ornamental design for a electric hair straightener, as shown and described.

DESCRIPTION

FIG. 1 shows a front view of the design for an electric hair straightener according to the invention.

FIG. 2 shows a rear view of the design for an electric hair straightener according to the invention.

FIG. 3 shows a top view of the design for an electric hair straightener according to the invention.

FIG. 4 shows a bottom view of the design for an electric hair straightener according to the invention.

FIG. 5 shows a left side view of the design for an electric hair straightener according to the invention.

FIG. 6 shows a right side view of the design for an electric hair straightener according to the invention.

FIG. 7 shows a perspective view of the design for an electric hair straightener according to the invention; and,

FIG. 8 shows a perspective view of the design for an electric hair straightener in the open position according to the invention.

1 Claim, 4 Drawing Sheets

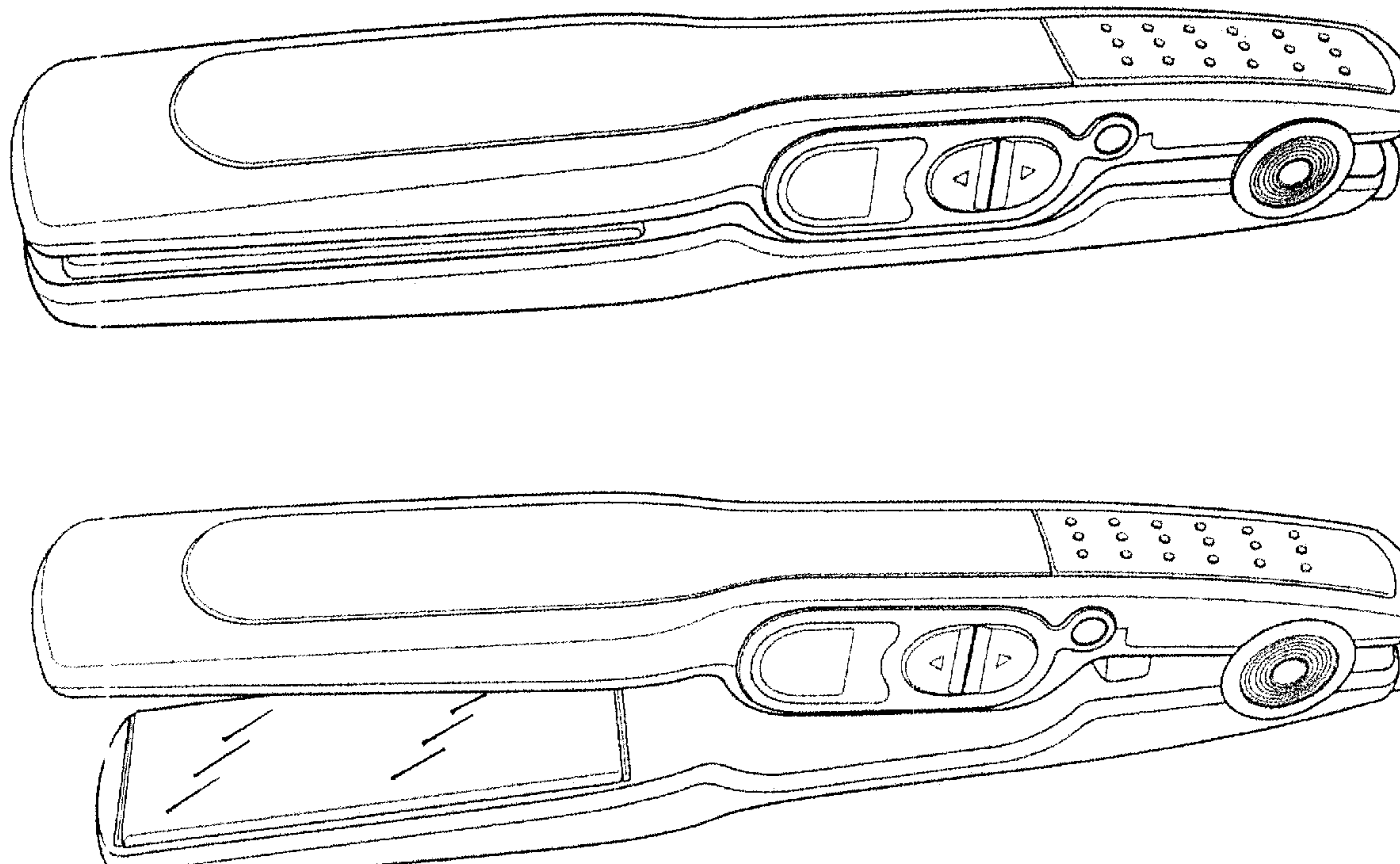

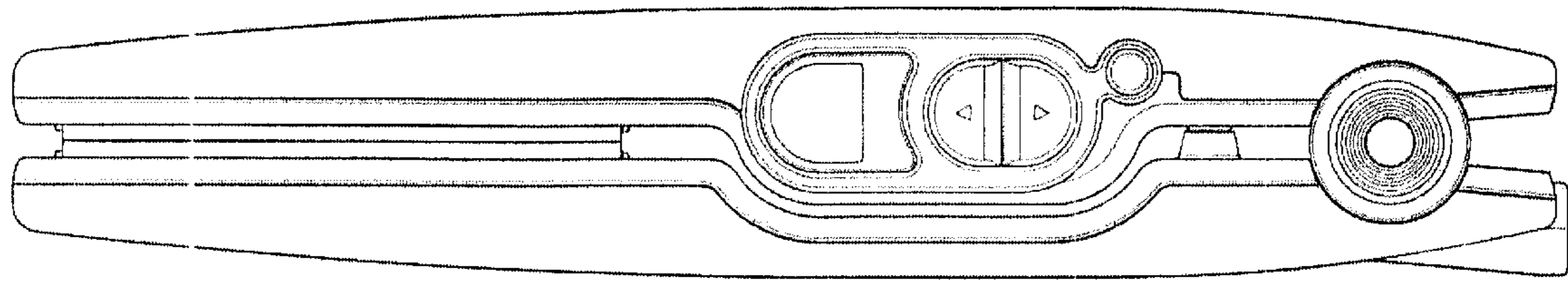

FIGURE 1

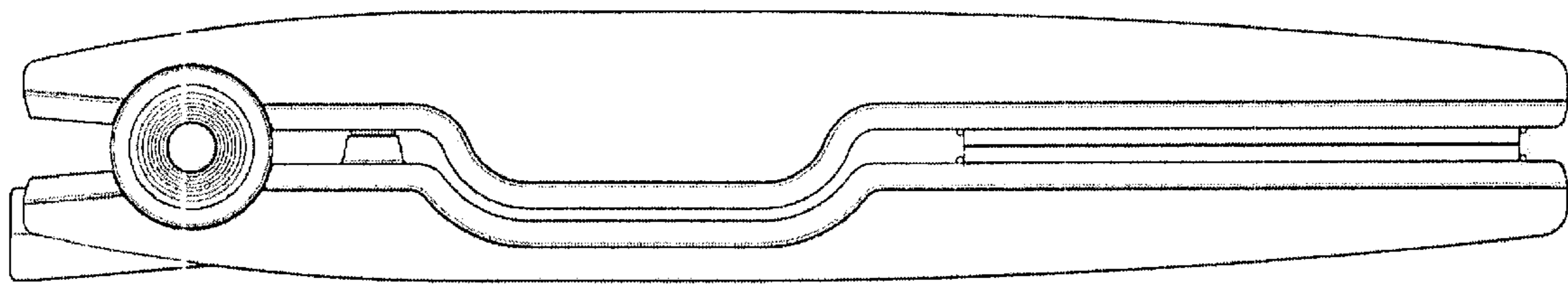

FIGURE 2

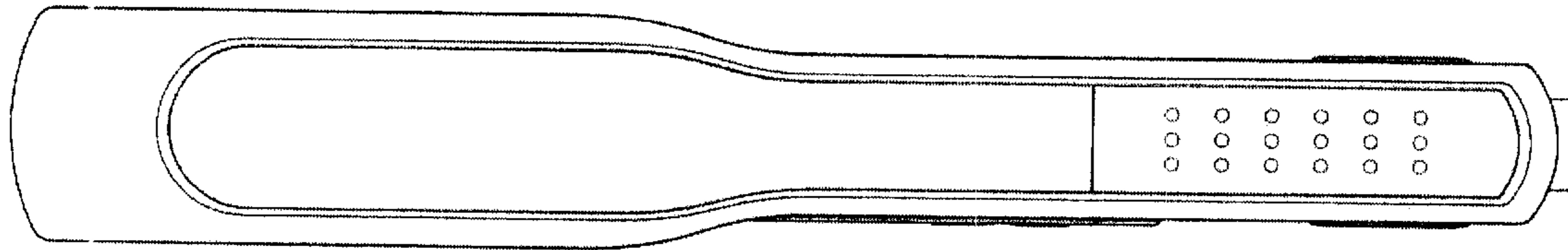

FIGURE 3

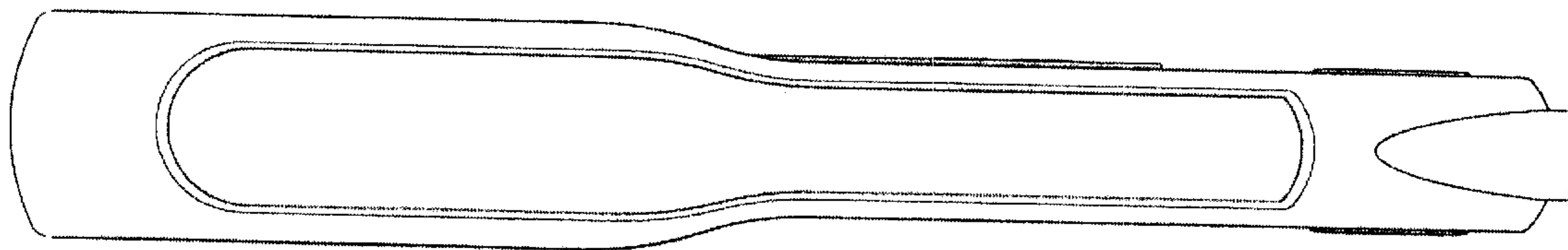

FIGURE 4

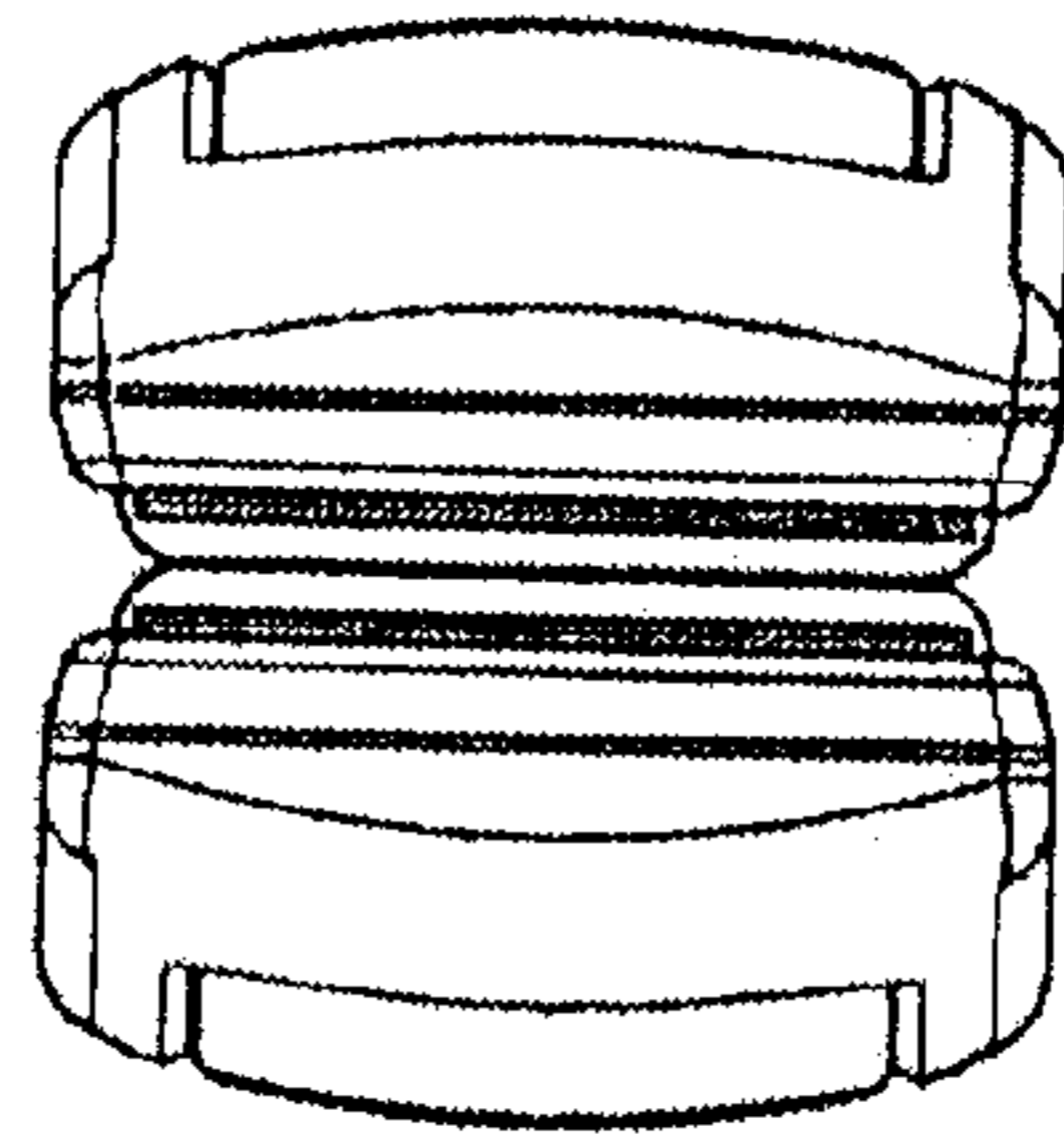

FIGURE 5

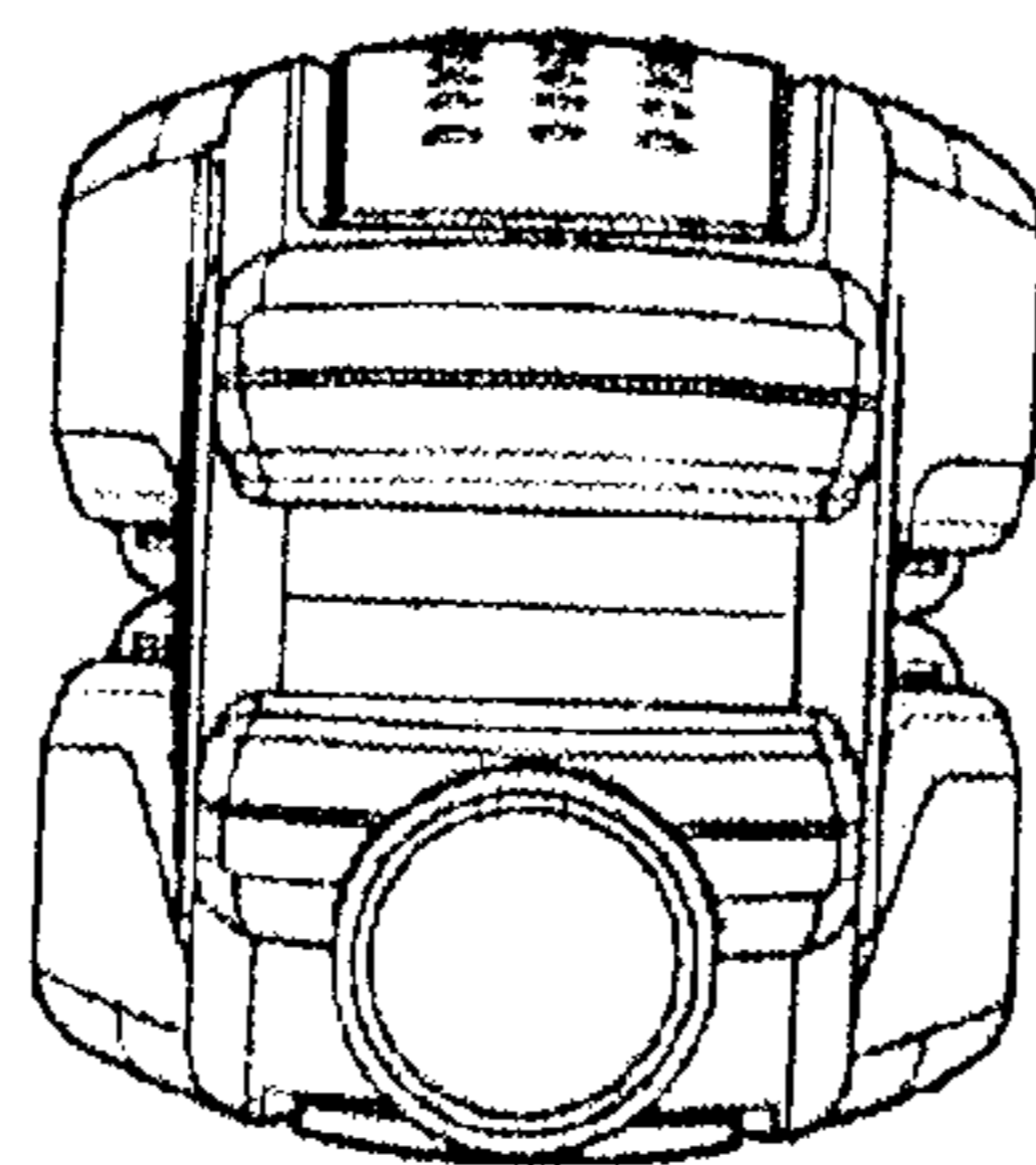

FIGURE 6

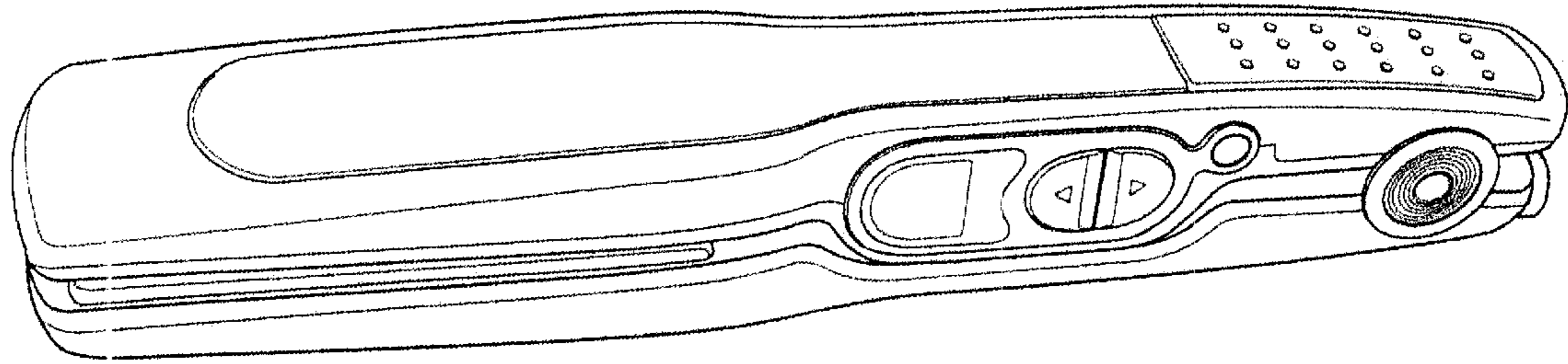

FIGURE 7

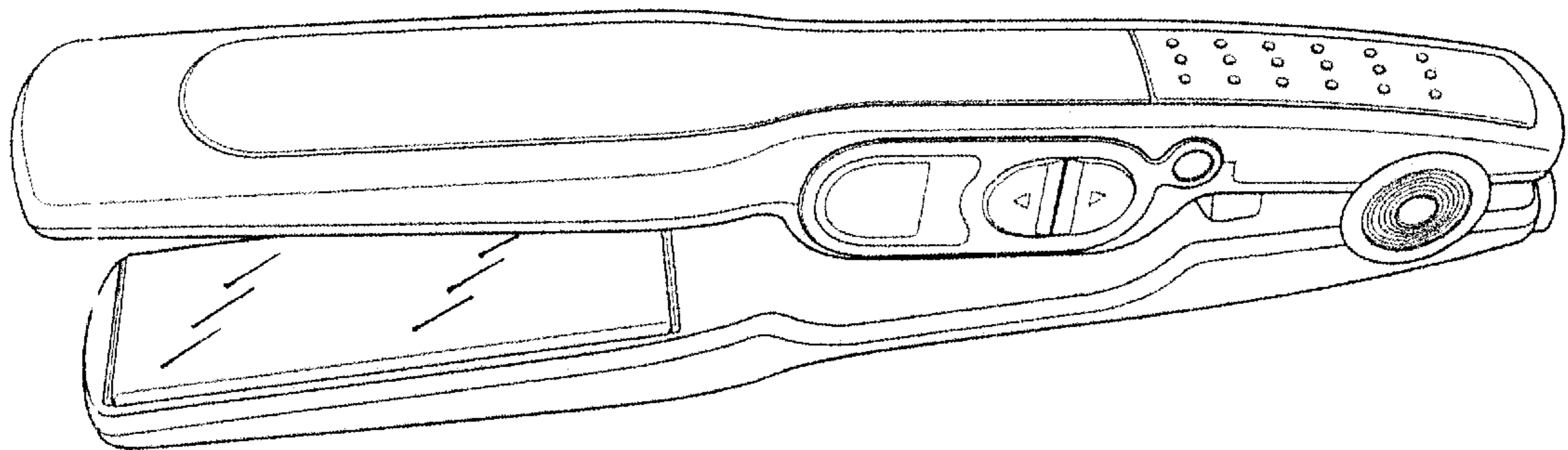

FIGURE 8